

Data-Over-Cable Service Interface Specifications

DCA - MHA v2

Remote Upstream External PHY Interface Specification

CM-SP-R-UEPI-I11-190912

ISSUED

Notice

This DOCSIS® specification is the result of a cooperative effort undertaken at the direction of Cable Television Laboratories, Inc. for the benefit of the cable industry and its customers. You may download, copy, distribute, and reference the documents herein only for the purpose of developing products or services in accordance with such documents, and educational use. Except as granted by CableLabs® in a separate written license agreement, no license is granted to modify the documents herein (except via the Engineering Change process), or to use, copy, modify or distribute the documents for any other purpose.

This document may contain references to other documents not owned or controlled by CableLabs. Use and understanding of this document may require access to such other documents. Designing, manufacturing, distributing, using, selling, or servicing products, or providing services, based on this document may require intellectual property licenses from third parties for technology referenced in this document. To the extent this document contains or refers to documents of third parties, you agree to abide by the terms of any licenses associated with such third-party documents, including open source licenses, if any.

© Cable Television Laboratories, Inc. 2014-2019

DISCLAIMER

This document is furnished on an "AS IS" basis and neither CableLabs nor its members provides any representation or warranty, express or implied, regarding the accuracy, completeness, noninfringement, or fitness for a particular purpose of this document, or any document referenced herein. Any use or reliance on the information or opinion in this document is at the risk of the user, and CableLabs and its members shall not be liable for any damage or injury incurred by any person arising out of the completeness, accuracy, or utility of any information or opinion contained in the document.

CableLabs reserves the right to revise this document for any reason including, but not limited to, changes in laws, regulations, or standards promulgated by various entities, technology advances, or changes in equipment design, manufacturing techniques, or operating procedures described, or referred to, herein.

This document is not to be construed to suggest that any company modify or change any of its products or procedures, nor does this document represent a commitment by CableLabs or any of its members to purchase any product whether or not it meets the characteristics described in the document. Unless granted in a separate written agreement from CableLabs, nothing contained herein shall be construed to confer any license or right to any intellectual property. This document is not to be construed as an endorsement of any product or company or as the adoption or promulgation of any guidelines, standards, or recommendations.

Document Status Sheet

Document Control Number:	CM-SP-R-UEPI-I11-190912			
Document Title:	Remote Upstream External PHY Interface Specification			
Revision History:	I01 - Released 06/15/2015 I02 - Released 01/21/2016 I03 - Released 05/12/2016 I04 - Released 09/23/2016 I05 - Released 01/11/2017 I06 - Released 05/24/2017 I07 - Released 09/06/2017 I08 - Released 12/20/2017 I09 - Released 09/26/2018 I10 - Released 03/07/2019	I11 - Released 09/12/19		
Date:	September 12, 2019			
Status:	<i>Work in Progress</i>	<i>Draft</i>	Issued	<i>Closed</i>
Distribution Restrictions:	<i>Author Only</i>	<i>CL/Member</i>	<i>CL/Member/ Vendor</i>	Public

Key to Document Status Codes

Work in Progress	An incomplete document, designed to guide discussion and generate feedback that may include several alternative requirements for consideration.
Draft	A document in specification format considered largely complete, but lacking review by Members and vendors. Drafts are susceptible to substantial change during the review process.
Issued	A generally public document that has undergone Member and Technology Supplier review, cross-vendor interoperability, and is for Certification testing if applicable. Issued Specifications are subject to the Engineering Change Process.
Closed	A static document, reviewed, tested, validated, and closed to further engineering change requests to the specification through CableLabs.

Trademarks

CableLabs® is a registered trademark of Cable Television Laboratories, Inc. Other CableLabs marks are listed at <http://www.cablelabs.com/certqual/trademarks>. All other marks are the property of their respective owners.

Table of Contents

1	SCOPE	7
1.1	Introduction and Purpose	7
1.2	MHAV2 Interface Documents	7
1.3	Requirements and Conventions	7
2	REFERENCES	9
2.1	Normative References.....	9
2.2	Informative References	9
2.3	Reference Acquisition.....	9
3	TERMS AND DEFINITIONS	10
4	ABBREVIATIONS AND ACRONYMS	13
5	TECHNICAL OVERVIEW	16
5.1	System Architecture.....	16
5.1.1	Reference Architecture.....	16
5.2	R-UEPI Theory of Operation.....	16
5.2.1	UEPI Embedded Architecture.....	17
5.2.2	R-UEPI System Architecture.....	18
5.3	System Description	18
5.3.1	UEPI Entities	18
5.3.2	Types of UEPI Pseudowires.....	18
5.4	Theory of Operation.....	19
6	PHYSICAL LAYER REQUIREMENTS	20
6.1	Upstream PHY	20
6.1.1	Latency.....	20
6.1.2	Skew	21
7	R-UEPI CONTROL PLANE	22
8	UEPI FORWARDING PLANE	23
8.1	UEPI Transport Packet Format	23
8.1.1	Ethernet 802.3 Header.....	24
8.1.2	Ethernet 802.1q Header.....	24
8.1.3	IPv4 Header.....	25
8.1.4	IPv6 Header.....	25
8.1.5	L2TPv3 Session ID Header.....	25
8.1.6	PSP Sub-Layer Header.....	26
8.1.7	PSP Payload	27
8.1.8	CRC.....	27
8.2	UEPI Pseudowires	27
8.2.1	UEPI Data Pseudowire Format for an SC-QAM Channel	27
8.2.2	UEPI Data Pseudowire Format for an OFDMA Channel.....	31
8.2.3	UEPI RNG-REQ Pseudowire Format for an SC-QAM Channel	36
8.2.4	UEPI RNG-REQ Pseudowire Format for an OFDMA Channel.....	36
8.2.5	UEPI Request Pseudowire Format.....	39
8.2.6	UEPI MAP Pseudowire Format.....	42
8.2.7	UEPI Probe Pseudowire Format.....	43
8.2.8	UEPI Spectrum Management Pseudowire Format.....	46
8.2.9	UEPI PNM Transmission Unit Format.....	46
8.2.10	UEPI EC-REQ Pseudowire	50

9	UEPI OPERATION	52
9.1	No Burst Events	52
9.2	Quality of Service	53
9.3	Sequencing and Flow IDs	53
9.4	Bandwidth Request Aggregation	53
APPENDIX I	R-UEPI AND DMPI (INFORMATIVE)	55
APPENDIX II	ACKNOWLEDGEMENTS	56
APPENDIX III	REVISION HISTORY	57

List of Figures

Figure 1 - MHA v2/R-PHY System Architecture.....	16
Figure 2 - UEPI Embedded Architecture for SC-QAM Channel.....	17
Figure 3 - UEPI Embedded Architecture for OFDMA Channel.....	17
Figure 4 - UEPI IPv4 Packet with L2TPv3 Encapsulation	24
Figure 5 - Composition of an IPv6 Header	25
Figure 6 - Legacy PSP Sublayer Header and Payload	26
Figure 7 - UEPI Data Pseudowire Transmission Unit for an SC-QAM Channel	28
Figure 8 - UEPI Header Segment Format for an SC-QAM Channel.....	28
Figure 9 - UEPI Trailer Segment Format for an SC-QAM Channel.....	29
Figure 10 - UEPI Data Pseudowire Payload and Trailer Transmission Units for an OFDMA Channel.....	31
Figure 11 - UEPI Header Segment Format for an OFDMA Channel	32
Figure 12 - UEPI Trailer Segment Format.....	34
Figure 13 - UEPI RNG-REQ Header Segment Format	37
Figure 14 - UEPI RNG-REQ Trailer Segment Format.....	37
Figure 15 - UEPI REQ Block Format for an OFDMA Channel.....	39
Figure 16 - UEPI REQ Block Format for an SC-QAM Channel.....	41
Figure 17 - Segment Format for the UEPI MAP Pseudowire for MAP Frames for an SC-QAM Channel.....	42
Figure 18 - Segment Format for the UEPI MAP Pseudowire (Version 5) Non-probe MAP Frames for an OFDMA Channel.....	43
Figure 19 - Segment Format for the UEPI MAP Pseudowire for Version 5 Probe Frames.....	43
Figure 20 - UEPI Probe Pseudowire Transmission Unit	44
Figure 21 - UEPI Probe Pseudowire Header Segment.....	44
Figure 22 - UEPI Probe Payload Format	45
Figure 23 - Upstream Capture for Active and Quiet Probes Transmission Unit.....	47
Figure 24 - RxMER Pseudowire Transmission Unit Format.....	49
Figure 25 - UEPI EC-REQ Block Format	51

List of Tables

Table 1 - Nominal DOCSIS PHY Latency	20
Table 2 - Maximum DOCSIS MAC Preprocessor Latency	20
Table 3 - Composition of a PSP Sublayer Header	26

Table 4 - UEPI Pseudowire Summary	27
Table 5 - UEPI Header Segment for an SC-QAM Channel.....	29
Table 6 - UEPI Trailer Segment for an SC-QAM Channel	30
Table 7 - UEPI Header Segment for an OFDMA Channel.....	33
Table 8 - UEPI Trailer Segment for an OFDMA Channel	34
Table 9 - UEPI RNG-REQ Header Segment	37
Table 10 - UEPI RNG-REQ Trailer Segment.....	38
Table 11 - UEPI Request Block.....	40
Table 12 - UEPI Request Block for an SC-QAM Channel.....	41
Table 13 - UEPI Probe Header Segment	44
Table 14 - UEPI Probe Payload Format.....	45
Table 15 - Status Byte Encoding in PNM Transmission Unit Header	47
Table 16 - UEPI Header Segment for Upstream Capture for Active and Quiet Probes.....	48
Table 17 - UEPI Upstream Capture for Active and Quiet Probes Payload Segment.....	48
Table 18 - UEPI RxMER Header Segment	49
Table 19 - UEPI RxMER Payload Segment	49
Table 20 - UEPI RxMER per Subcarrier Trailer Segment.....	50
Table 21 - No Burst Event Responses	52
Table 22 - R-UEPI's DMPI-defined Transport Path	55

1 SCOPE

1.1 Introduction and Purpose

This specification describes the interface between a DOCSIS upstream PHY chip and a DOCSIS upstream MAC chip. This interface is similar to R-DEPI (see [R-DEPI]) that describes the interface between a DOCSIS downstream MAC chip and a DOCSIS downstream PHY chip.

The interface is referred to as the Remote Upstream External Physical Interface or R-UEPI (pronounced R - U - EPI). Its name is derived from R-DEPI. R-UEPI uses the same protocol structures as R-DEPI, including L2TPv3 with a Packet Streaming Protocol (PSP) pseudowire, with some additional extensions.

This specification defines two scenarios in which R-UEPI can be deployed:

1. **System Scenario:** The MAC chip is located in one chassis and the PHY chip is located in another chassis. In between them is the Converged Interconnect Network (CIN), typically comprising Ethernet switches and routers.
2. **Embedded Scenario:** The MAC chip and the PHY chip are located on the same assembly such as the same PCB (printed circuit board) or a similar structure. In between them is an embedded Ethernet structure that may go through one or more Ethernet switch chips which may switch on either Layer 2, 3, or 4 headers.

This version of the specification includes both scenarios, though the main intent of this document is focused on the System Scenario which applies to the MHA v2/R-PHY System Architecture.

Technically, in the embedded scenario, the PHY chip is no longer external to the MAC chip. However, the combination of the MAC and PHY chip may or may not be co-located with the packet processing functions of the upstream path. Making that choice is beyond the scope of this specification.

The System Scenario requires a forwarding plane protocol as well as a control plane protocol. The Embedded Scenario only requires a forwarding plane protocol because the PHY, MAC, and Ethernet Switch chips are all assumed to be locally programmable.

R-UEPI is a member of the proposed MHA v2 (Modular Headend Architecture, version 2) specifications.

1.2 MHA v2 Interface Documents

A list of the documents in the MHA v2 family of specifications is provided below. For updates, refer to <http://www.cablelabs.com/specs/specification-search/>.

Designation	Title
CM-SP-R-PHY	Remote PHY Specification
CM-SP-R-DEPI	Remote Downstream External PHY Interface Specification
CM-SP-R-UEPI	Remote Upstream External PHY Interface Specification
CM-SP-GCP	Generic Control Plane Specification
CM-SP-R-DTI	Remote DOCSIS Timing Interface Specification
CM-SP-R-OOB	Remote Out-of-Band Specification
CM-SP-R-OSSI	Remote PHY OSS Interface Specification

NOTE: MHA v2 does not explicitly use any of the original Modular Headend Architecture specifications.

1.3 Requirements and Conventions

In this specification, the following convention applies any time a bit field is displayed in a figure. The bit field should be interpreted by reading the figure from left to right, then from top to bottom, with the MSB being the first bit read and the LSB being the last bit read.

Throughout this document, the words that are used to define the significance of particular requirements are capitalized. These words are:

"MUST"	This word means that the item is an absolute requirement of this specification.
"MUST NOT"	This phrase means that the item is an absolute prohibition of this specification.
"SHOULD"	This word means that there may exist valid reasons in particular circumstances to ignore this item, but the full implications should be understood and the case carefully weighed before choosing a different course.
"SHOULD NOT"	This phrase means that there may exist valid reasons in particular circumstances when the listed behavior is acceptable or even useful, but the full implications should be understood and the case carefully weighed before implementing any behavior described with this label.
"MAY"	This word means that this item is truly optional. One vendor may choose to include the item because a particular marketplace requires it or because it enhances the product, for example; another vendor may omit the same item.

2 REFERENCES

At the time of publication, the editions indicated were valid. All references are subject to revision, and users of this document are encouraged to investigate the possibility of applying the most recent editions of the documents listed below. References are either specific (identified by date of publication, edition number, version number, etc.) or non-specific. For a nonspecific reference, the latest version applies.

2.1 Normative References

In order to claim compliance with this specification, it is necessary to conform to the following standards and other works as indicated, in addition to the other requirements of this specification. Notwithstanding, intellectual property rights may be required to use or implement such normative references.

[DEPI]	DOCSIS Downstream External PHY Interface Specification, CM-SP-DEPI-I08-100611, June 11, 2010, Cable Television Laboratories, Inc.
[DRFI]	DOCSIS Downstream Radio Frequency Interface, CM-SP-DRFI-I16-170111, January 11, 2017, Cable Television Laboratories, Inc.
[MULPIv3.0]	DOCSIS MAC and Upper Layer Protocols Interface Specification, CM-SP-MULPIv3.0-C01-171207, December 7, 2017, Cable Television Laboratories, Inc.
[MULPIv3.1]	DOCSIS MAC and Upper Layer Protocols Interface Specification, CM-SP-MULPIv3.1-I18-190422, April 22, 2019, Cable Television Laboratories, Inc.
[IEEE 802.1q]	IEEE Std 802.1Q-2003, Virtual Bridged Local Area Networks, May 2003.
[IEEE 802.3]	IEEE Std 802.3-2002, Part 3: Carrier Sense Multiple Access With Collision Detection (CSMA/CD) Access Method and Physical Layer Specifications, March 2002.
[ISO 13818-1]	ISO/IEC 13818-1:2013, Information Technology, Generic Coding of Moving Pictures and Associated Audio Information. Part 1: System, May 23, 2013.
[PHYv3.1]	DOCSIS Physical Layer Specification, CM-SP-PHYv3.1-I16-190121, January 21, 2019, Cable Television Laboratories, Inc.
[R-DEPI]	Remote Downstream External PHY Interface Specification, CM-SP-R-DEPI-I13-190912, September 12, 2019, Cable Television Laboratories, Inc.
[R-PHY]	Remote PHY Specification, CM-SP-R-PHY-I13-190912, September 12, 2019, Cable Television Laboratories, Inc.
[RFC 791]	IETF RFC 791, Internet Protocol-DARPA, September 1981.
[RFC 2460]	IETF RFC 2460, Internet Protocol, Version 6 (IPv6) Specification, December 1998.
[RFC 2474]	IETF RFC 2474, Definition of the Differentiated Services Field (DS Field) in the IPv4 and IPv6 Headers, December 1998.
[RFC 3931]	IETF RFC 3931, Layer Two Tunneling Protocol - Version 3 (L2TPv3), March 2005.

2.2 Informative References

This specification uses the following informative references.

[VCCV]	IETF RFC 5085 Pseudowire Virtual Circuit Connectivity Verification (VCCV): A Control Channel for Pseudowires. T. Nadeau, Ed., C. Pignataro, Ed., December 2007.
--------	---

2.3 Reference Acquisition

- Cable Television Laboratories, Inc., 858 Coal Creek Circle, Louisville, CO 80027; Phone +1-303-661-9100; Fax +1-303-661-9199; <http://www.cablelabs.com>
- The Institute of Electrical and Electronics Engineers, Inc., Internet: <http://standards.ieee.org>
- International Organization for Standardization (ISO), Tel.: +41 22 749 02 22, Fax: +41 22 749 01 55, www.iso.org
- Internet Engineering Task Force (IETF) Secretariat, 48377 Fremont Blvd., Suite 117, Fremont, California 94538, USA, Phone: +1-510-492-4080, Fax: +1-510-492-4001, <http://www.ietf.org>

3 TERMS AND DEFINITIONS

This specification uses the following terms:

Bonded Channels	A logical channel comprising multiple individual channels.
Cable Modem (CM)	A modulator-demodulator at subscriber locations intended for use in conveying data communications on a cable television system.
CCAP Core	A CCAP device that uses MHA v2 protocols to interconnect to an RPD.
Converged Interconnect Network	The network (generally gigabit Ethernet) that connects a CCAP Core to an RPD.
Customer Premises Equipment (CPE)	Equipment at the end user's premises; may be provided by the service provider.
Data Rate	Throughput, data transmitted in units of time usually in bits per second (bps).
Decibels (dB)	Ratio of two power levels expressed mathematically as $\text{dB} = 10\log_{10}(P_{\text{OUT}}/P_{\text{IN}})$.
Decibel-Millivolt (dBmV)	Unit of RF power expressed in decibels relative to 1 millivolt, where $\text{dBmV} = 20\log_{10}(\text{value in mV}/1 \text{ mV})$.
Downstream (DS)	<ol style="list-style-type: none"> 1. Transmissions from CMTS to CM. This includes transmission from the CCAP Core to the RPD, as well as the RF transmissions from the RPD to the CM. 2. RF spectrum used to transmit signals from a cable operator's head-end or hub site to subscriber locations.
Dynamic Host Configuration Protocol (DHCP)	A network protocol enabling a server to automatically assign an IP address to a network element.
Edge QAM Modulator (EQAM)	A headend or hub device that receives packets of digital video or data. It re-packetizes the video or data into an MPEG transport stream and digitally modulates the digital transport stream onto a downstream RF carrier using quadrature amplitude modulation (QAM).
Flow	A stream of packets in R-UEPI used to transport data of a certain priority from the CCAP Core to a particular QAM channel of the EQAM. In PSP operation, there can exist several flows per QAM channel.
Gbps	Gigabits per second
Gigahertz (GHz)	A unit of frequency; 1,000,000,000 or 10^9 Hz.
GigE (GE)	Gigabit Ethernet (1 Gbps)
Hertz (Hz)	A unit of frequency; formerly cycles per second
Hybrid Fiber/Coax (HFC) System	A broadband bidirectional shared-media transmission system using optical fiber trunks between the head-end and the fiber nodes, and coaxial cable distribution from the fiber nodes to the customer locations.
Institute of Electrical and Electronic Engineers (IEEE)	A voluntary organization which, among other things, sponsors standards committees and is accredited by the American National Standards Institute (ANSI).
Internet Engineering Task Force (IETF)	A body responsible for, among other things, developing standards used in the Internet.
Internet Protocol (IP)	An Internet network-layer protocol
kilohertz (kHz)	Unit of frequency; 1,000 or 10^3 Hz; formerly kilocycles per second
L2SS	Layer 2 Specific Sublayer. R-UEPI is an L2SS of L2TPv3.
L2TP Access Concentrator (LAC)	If an L2TP Control Connection Endpoint (LCCE) is being used to cross-connect an L2TP session directly to a data link, we refer to it as an L2TP Access Concentrator (LAC). An LCCE may act as both an L2TP Network Server (LNS) for some sessions and an LAC for others, so these terms must only be used within the context of a given set of sessions unless the LCCE is, in fact, single purpose for a given topology.
L2TP Attribute Value Pair (AVP)	The L2TP variable-length concatenation of a unique Attribute (represented by an integer), a length field, and a Value containing the actual value identified by the attribute.
L2TP Control Connection	An L2TP control connection is a reliable control channel that is used to establish, maintain, and release individual L2TP sessions, as well as the control connection itself.

L2TP Control Connection Endpoint (LCCE)	An L2TP node that exists at either end of an L2TP control connection. May also be referred to as an LAC or LNS, depending on whether tunneled frames are processed at the data link (LAC) or network layer (LNS).
L2TP Control Connection ID	The Control Connection ID field contains the identifier for the control connection, a 32-bit value. The Assigned Control Connection ID AVP, Attribute Type 61, contains the ID being assigned to this control connection by the sender. The Control Connection ID specified in the AVP must be included in the Control Connection ID field of all control packets sent to the peer for the lifetime of the control connection. Because a Control Connection ID value of 0 is used in this special manner, the zero value must not be sent as an Assigned Control Connection ID value.
L2TP Control Message	An L2TP message used by the control connection.
L2TP Data Message	message used by the data channel
L2TP Endpoint	A node that acts as one side of an L2TP tunnel
L2TP Network Server (LNS)	If a given L2TP session is terminated at the L2TP node and the encapsulated network layer (L3) packet processed on a virtual interface, we refer to this L2TP node as an L2TP Network Server (LNS). A given LCCE may act as both an LNS for some sessions and an LAC for others, so these terms must only be used within the context of a given set of sessions unless the LCCE is in fact single purpose for a given topology.
L2TP Pseudowire (PW)	An emulated circuit as it traverses a packet-switched network. There is one Pseudowire per L2TP Session.
L2TP Pseudowire Type	The payload type being carried within an L2TP session. Examples include PPP, Ethernet, and Frame Relay.
L2TP Session	An L2TP session is the entity that is created between two LCCEs in order to exchange parameters for and maintain an emulated L2 connection. Multiple sessions may be associated with a single Control Connection.
L2TP Session ID	A 32-bit field containing a non-zero identifier for a session. L2TP sessions are named by identifiers that have local significance only. That is, the same logical session will be given different Session IDs by each end of the control connection for the life of the session. When the L2TP control connection is used for session establishment, session IDs are selected and exchanged as Local Session ID AVPs during the creation of a session. The Session ID alone provides the necessary context for all further packet processing, including the presence, size, and value of the Cookie, the type of L2-Specific Sublayer, and the type of payload being tunneled.
MAC Domain	A grouping of Layer 2 devices that can communicate with each other without using bridging or routing. In DOCSIS architecture is the group of CMs that are using upstream and downstream channels linked together through a MAC forwarding entity.
Maximum Transmission Unit (MTU)	Maximum size of the Layer 3 payload of a Layer 2 frame.
Mbps	Megabits per second
Media Access Control (MAC)	Used to refer to the Layer 2 element of the system which would include DOCSIS framing and signaling.
Megahertz (MHz)	A unit of frequency; 1,000,000 or 10^6 Hz; formerly megacycles per second
Microsecond (μs)	10^{-6} second
Millisecond (ms)	10^{-3} second
Modulation Error Ratio (MER)	The ratio of the average symbol power to average error power.
Multiple System Operator (MSO)	A corporate entity that owns and/or operates more than one cable system.
Nanosecond (ns)	10^{-9} second
Packet Identifier (PID)	PID (system): A unique integer value used to identify elementary streams of a program in a single or multi-program Transport Stream as described in section 2.4.3 of ITU-T Rec. H.222.0 [ISO 13818-1].
Physical Media Dependent (PMD) Sublayer	A sublayer of the Physical layer which is concerned with transmitting bits or groups of bits over particular types of transmission link between open systems and which entails electrical, mechanical, and handshaking procedures.
Precision Time Protocol	A protocol used to synchronize clocks throughout a network.

Program Clock Reference (PCR)	A timestamp in the Video Transport Stream from which decoder timing is derived.
QAM channel (QAM ch)	Analog RF channel that uses quadrature amplitude modulation (QAM) to convey information
Quadrature Amplitude Modulation (QAM)	A modulation technique in which an analog signal's amplitude and phase vary to convey information, such as digital data.
Radio Frequency (RF)	In cable television systems, this refers to electromagnetic signals in the range 5 to 1000 MHz.
Radio Frequency Interface	Term encompassing the downstream and the upstream radio frequency interfaces.
Request For Comments (RFC)	A technical policy document of the IETF; these documents can be accessed on the World Wide Web at http://www.rfc-editor.org/ .
R-PHY Device	The R-PHY Device (RPD) is a device in the network which implements the Remote-PHY specification to provide conversion from digital Ethernet transport to analog RF transport.
Session	An L2TP data plane connection from the CCAP Core to the QAM channel. There must be one session per QAM Channel. There is one R-UEPI pseudowire type per session. There may be one MPT flow or one or more PSP flows per session. Multiple sessions may be bound to a single control connection.
StopCCN	L2TPv3 Stop-Control-Connection-Notification message.
Trivial File Transfer Protocol (TFTP)	A file transfer protocol. Generally used for automated transfer of configuration or boot files between machines
Upconverter	A device used to change the frequency range of an analog signal, usually converting from a local oscillator frequency to an RF transmission frequency.
Upstream (US)	<ol style="list-style-type: none"> 1. Transmissions from CM to CMTS. This includes transmission from the RPD to CCAP Core as well as the RF transmissions from the CM to the RPD. 2. RF spectrum used to transmit signals from a subscriber location to a cable operator's headend or hub site.
Upstream Channel Descriptor (UCD)	The MAC Management Message used to communicate the characteristics of the upstream physical layer to the cable modems.
Video on Demand (VoD) System	System that enables individuals to select and watch video content over a network through an interactive television system.

4 ABBREVIATIONS AND ACRONYMS

This specification uses the following abbreviations:

ACK	L2TPv3 Explicit Acknowledgement message
AVP	L2TPv3 Attribute Value Pair
CCAP	Converged Cable Access Platform
CDN	L2TPv3 Call-Disconnect-Notify message
CIN	Converged Interconnect Network
CM	Cable Modem
CMTS	Cable Modem Termination System
CPE	Customer Premises Equipment
CoS	Class of Service
CRC	Cyclic Redundancy Check
CSMA	Carrier Sense Multiple Access
dB	Decibels
dBmV	Decibel-Millivolt
DCA	Distributed CCAP Architecture
DEPI	Downstream External-PHY Interface
DHCP	Dynamic Host Configuration Protocol
DOCSIS	Data-Over-Cable Service Interface Specifications
DOCSIS-MPT (D-MPT)	DOCSIS MPT Mode
DRFI	Downstream Radio Frequency Interface
DS	Downstream
DSCP	Differentiated Services Code Point
DTI	DOCSIS Timing Interface
DTS	DOCSIS Timestamp, 32-bit
EAP	Extensible Authentication Protocol
EQAM	Edge QAM
FDM	Frequency Division Multiplex
FEC	Forward Error Correction
Gbps	Gigabits per second
GCP	Generic Control Protocol
GHz	Gigahertz
GE	Gigabit Ethernet (Gig E)
HCS	Header Check Sequence
HELLO	L2TPv3 Hello message
HFC	Hybrid Fiber/Coax
Hz	Hertz
I-CCAP	Integrated CCAP
ICCN	L2TPv3 Incoming-Call-Connected message
I-CMTS	Integrated CMTS
ICRP	L2TPv3 Incoming-Call-Reply message
ICRQ	L2TPv3 Incoming-Call-Request message
IEEE	Institute of Electrical and Electronic Engineers
IETF	Internet Engineering Task Force
IKE	Internet Key Exchange
IP	Internet Protocol
IPv4	Internet Protocol version 4

IPv6	Internet Protocol version 6
I/Q	In-phase Quadrature (Used to denote the complex RF data format)
ISO	International Standards Organization
ITU	International Telecommunication Union
ITU-T	Telecommunication Standardization Sector of the International Telecommunication Union
IUC	Interval Usage Code
kbps	Kilobits per second
kHz	Kilohertz
L2TP	Layer 2 Transport Protocol
L2TPv3	Layer 2 Transport Protocol-version 3
L3	Layer 3
LAC	L2TP Access Concentrator
LC	Logical Channel
LCCE	L2TP Control Connection Endpoint
LNS	L2TP Network Server
LSB	Least Significant Bit
MAC	Media Access Control
MAP	Upstream Bandwidth Allocation Map (referred to only as MAP)
Mbps	Megabits per second
MCM	Multi-channel MPEG
M-CMTS	Modular Cable Modem Termination System
MER	Modulation Error Ratio
MHAv2	Modular Headend Architecture version 2
MHz	Megahertz
MPEG	Moving Picture Experts Group
MPEG-TS	Moving Picture Experts Group Transport Stream
MPT	MPEG-TS mode of R-DEPI
MPTS	Multi Program Transport Stream
ms	Millisecond
MSB	Most Significant Bit
MSO	Multiple System Operator
MTU	Maximum Transmission Unit
NAD	Network Access Device
ns	Nanosecond
OFDMA	Orthogonal Frequency Division Multiple Access
OSSI	Operations System Support Interface
OUI	Organizationally Unique Identifier
PCR	Program Clock Reference
PHB	Per Hop Behavior
PHY	Physical Layer
PID	Packet Identifier
PMD	Physical Media Dependent Sublayer
PNM	Proactive Network Maintenance
PPP	Point-to-Point Protocol
PSP	Packet Streaming-Protocol
PTP	Precision Time Protocol
PW	Pseudowire
QAM	Quadrature Amplitude Modulation

R-DEPI	Remote Downstream External PHY Interface
R-UEPI	Remote Upstream External PHY Interface
RDC	Regional Data Center
REQ	Request
RF	Radio Frequency
RFC	Request For Comments
RFI	Radio Frequency Interface
RPD	Remote PHY Device
SCCRN	L2TPv3 Start-Control-Connection-Connected message
SCCRP	L2TPv3 Start-Control-Connection-Reply message
SCCRQ	L2TPv3 Start-Control-Connection-Request message
S-CDMA	Synchronous Code Division Multiple Access
SC-QAM	Single Carrier Quadrature Amplitude Modulation
SID	Service Identifier
SLI	L2TPv3 Set Link Info message
SNR	Signal-to-Noise Ratio
SpecMan	Spectrum Management
SPTS	Single Program Transport Stream
StopCCN	L2TPv3 Stop-Control-Connection-Notification message
TCI	Tag Control Information
TFTP	Trivial File Transfer Protocol
TPID	Tag Protocol Identifier
TSID	MPEG2 Transport Stream ID
UCD	Upstream Channel Descriptor
UDP	User Datagram Protocol
US	Upstream
VLAN	Virtual Local Area Network
VoD	Video On Demand

5 TECHNICAL OVERVIEW

5.1 System Architecture

5.1.1 Reference Architecture

The architecture for a MHA_v2/R-PHY system is shown in Figure 1. This architecture contains several pieces of equipment along with interfaces between those pieces of equipment. This section briefly introduces each device and interface.

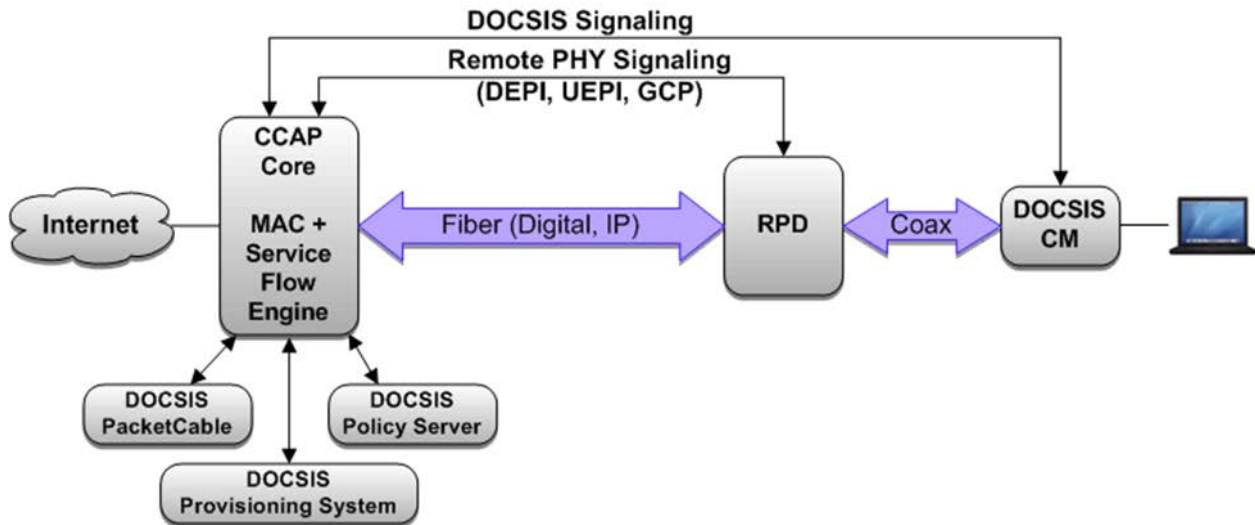

Figure 1 - MHA_v2/R-PHY System Architecture

The Remote PHY Device (RPD) is a device that has network interface on one side and an RF interface on the other side. The RPD provides Layer 1 PHY conversion, Layer 2 MAC conversion, and Layer 3 pseudowire support. The RPD RF output may be RF combined with other overlay services such as analog or digital video services.

The CCAP Core contains everything a traditional CCAP does, except for functions performed in the RPD. The CCAP Core contains the downstream DOCSIS MAC, the upstream DOCSIS MAC, all the initialization and operational DOCSIS-related software as well as the majority of the video EQAM functions.

R-DEPI, the Downstream External PHY Interface, is the downstream interface between the CCAP Core and the RPD. R-DEPI is explained fully in [R-DEPI].

R-UEPI, the Upstream External PHY Interface, is the upstream interface between the RPD and the CCAP Core. Like R-DEPI, it is an IP pseudowire between the PHY and MAC in an MHA_v2 system that contains both a data path for DOCSIS frames, and a control path for setting up, maintaining, and tearing down sessions.

NSI, or the Network Side Interface, is unchanged, and is the physical interface the CMTS uses to connect to the backbone network. Today, this is typically 10 Gbps Ethernet.

CMCI, or Cable Modem to Customer Premise Equipment Interface, is also unchanged, and is typically Ethernet, USB, or Wi-Fi.

5.2 R-UEPI Theory of Operation

An R-UEPI architecture consists of a series of UEPI entities interconnected with a series of UEPI pseudowires.

5.2.1 UEPI Embedded Architecture

A block diagram of the UEPI Embedded Architecture is shown in Figure 2 and Figure 3 for SC-QAM and OFDMA channels. There are two notable differences in the set of pseudowires. UEPI for an OFDMA channel includes a Probe pseudowire and a PNM pseudowire instead of a SpecMan pseudowire.

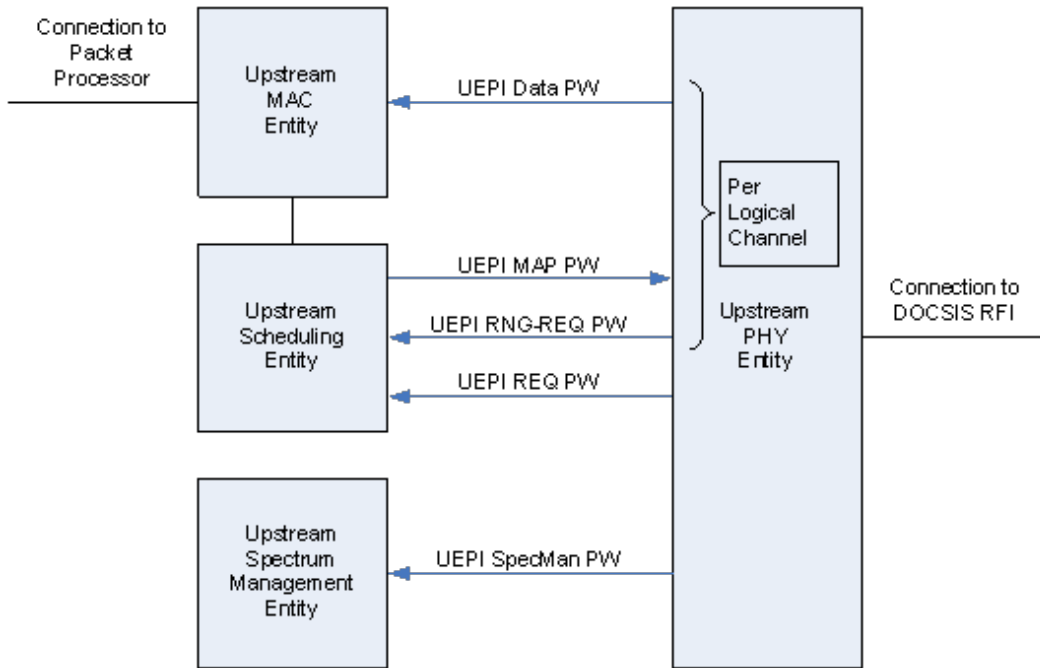

Figure 2 - UEPI Embedded Architecture for SC-QAM Channel

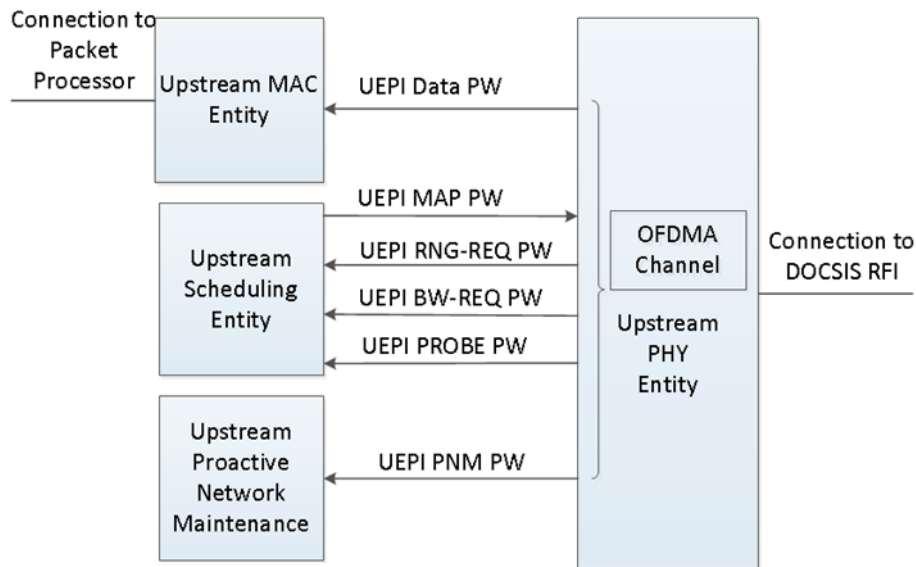

Figure 3 - UEPI Embedded Architecture for OFDMA Channel

In the Integrated CMTS scenarios, which would be an UEPI Embedded Architecture scenario, all the UEPI entities would be co-located within the same assembly. As a result, the UEPI control plane does not need to use L2TPv3 signaling. Instead, a local CPU can do UEPI configuration through direct register access.

NOTE: The interface between the upstream Scheduling Entity and the upstream MAC Entity is not defined in this specification.

5.2.2 R-UEPI System Architecture

In the R-PHY System Architecture scenario, R-UEPI Entities might be located in different assemblies that are separated by a network. The MAC and PHY Entities that are not co-located communicate using an R-UEPI control plane that is based upon an extension to the L2TPv3 control plane.

NOTE: This release of the document addresses only the R-UEPI forwarding plane. The R-UEPI control plane is defined separately in the [R-DEPI] specification.

NOTE: When the text uses the term 'UEPI', the assumed context is Remote-UEPI as used within an R-PHY system architecture, unless specifically called out as referring to the embedded architecture (Integrated CMTS).

5.3 System Description

5.3.1 UEPI Entities

The architectures discussed in Section 5.2 are based on the following upstream entities:

PHY Entity	Receives the DOCSIS burst from the RF Interface. The PHY Entity contains physical interfaces that are then divided into DOCSIS logical channels.
MAC Entity	Processes the DOCSIS bursts and manages DOCSIS MAC Management messages with the exception of any messages that get sent to the UEPI Scheduling Entity.
Scheduling Entity	Receives and processes the extracted request messages and ranging requests messages and generates MAP messages. Note that although the upstream Scheduling Entity is technically part of the DOCSIS MAC, the DOCSIS upstream scheduler is treated as a separate entity because in the UEPI system scenario, the upstream scheduler could be located in a physically separate location from the rest of the DOCSIS MAC.
Proactive Network Maintenance Entity	Provides post processing of spectrum management information captured by the RPD.

A UEPI entity could be part of an ASIC, an entire ASIC, a module, a printed circuit assembly, or an entire chassis. This specification avoids defining the exact physical embodiment of a UEPI entity.

For the purposes of this specification, the PHY Entity is considered to be contained within an RPD, and the MAC, Scheduling, and Proactive Network Maintenance entities are considered to be contained within a CCAP Core.

5.3.2 Types of UEPI Pseudowires

The exchange of content between the various UEPI entities is accomplished with pseudowires. All UEPI pseudowires use the PSP (Packet Streaming Protocol) Pseudowire format. A generic PSP pseudowire is capable of taking any content, breaking it into segments, and transporting those segments. PSP maintains a segment table in its header that identifies the length of the segments and indicates the segments that contain the beginning, middle, and end of the content. The PSP Pseudowire format is defined in the [R-DEPI] specification.

UEPI has seven categories of pseudowires. Each category retains the PSP pseudowire format but has a different purpose. Thus, the contents of the PSP payload are different for each category. The RPD contains a DOCSIS MAC preprocessor that encapsulates the DOCSIS upstream burst into the correct UEPI pseudowire.

The following UEPI pseudowires categories exist once for each instance of a DOCSIS OFDMA or an SC-QAM Logical Channel within the RPD, except in the case of Request pseudowires as noted below. Note that the format of data sent on pseudowires may vary for different types of channels.

Data PW	Contains a PSP segment containing a header with status, one or more PSP segments containing the DOCSIS burst, and a PSP segment containing a trailer with more status. In the case that no DOCSIS burst was received (known as a No Burst event), and a No Burst Transmission Unit is sent (see Section 9.1), the segments that would normally contain a DOCSIS burst are omitted. The UEPI Data Pseudowire connects from the RPD to the CCAP Core.
RNG-REQ PW	Contains a PSP segment containing a header with status, one PSP segment containing the DOCSIS ranging-request message, and a PSP segment containing a trailer with more status. The UEPI RNG-REQ Pseudowire connects from the RPD to the Scheduling Entity.
MAP PW	Uses one PSP segment containing a single DOCSIS MAP. The MAP Pseudowire connects from the Scheduling Entity to the RPD.

Request PW Contains one PSP segment that is filled with back-to-back Request Blocks, where each Request Block contains the information from an extracted DOCSIS request. In some cases the extracted requests could come from multiple DOCSIS channels. The Request Entity connects from the RPD to the Scheduling Entity.

The following UEPI Pseudowire category is defined only for SC-QAM physical channels within the RPD and exists at least once for each RPD.

SpecMan PW Contains one or more PSP segments that contain content from the spectrum management function in the RPD. (SpecMan is short for Spectrum Management). The SpecMan PW connects from the RPD to the Spectrum Management Entity.

The following two UEPI Pseudowire categories are defined only for OFDMA channels within the RPD and exist at least once for each RPD.

Probe PW Contains a PSP segment containing a header with status, one or more PSP segments containing the upstream PHY metrics measured from the probes sent from a cable modem. In the case that no probe was received, the segments that would normally contain the PHY metrics are omitted. The UEPI Probe Pseudowire connects from the RPD to the CCAP Core.

Proactive Management PW Contains one or more PSP segments that contain content from the Proactive Network Management (PNM) function in the RPD. The PNM PW connects from the RPD to the Spectrum Management Entity.

The distinction between each UEPI Pseudowire category is managed at session setup time. No specific bits in any UEPI header distinguish the various UEPI pseudowires categories from one another. Thus, the UEPI session ID is the sole indicator of the type of UEPI Pseudowire in use. This was done to permit a generic Layer 4 switch to reside between all the entities to forward the UEPI packets between the various UEPI entities based entirely on the L2TPv3 session ID without knowing any specific details of the UEPI protocol.

A pseudowire is generally defined as being bidirectional with a unique Session ID for each direction by each receiving entity. UEPI pseudowires only carry data in one direction (as noted in the descriptions above).

When the RPD encapsulates a DOCSIS burst into a UEPI pseudowire, the RPD may perform PSP fragmentation. This is typically done when the size of a DOCSIS upstream burst exceeds the UEPI MTU. The RPD does not perform PSP concatenation. This choice limits the scope of the implementation. Refer to [R-DEPI] for details on PSP fragmentation, PSP concatenation, and MTU procedures and definitions.

5.4 Theory of Operation

The RPD receives a DOCSIS burst from the RF interface.

The DOCSIS bursts may contain DOCSIS frames or DOCSIS segments which contain user data. The DOCSIS bursts may also contain DOCSIS MAC messages. The RPD does not terminate DOCSIS upstream concatenation, fragmentation, or bonding. Instead, the RPD places these DOCSIS bursts into a UEPI Data Pseudowire and passes them to the CCAP Core for decoding. DOCSIS standalone request messages (IUC 1) are not included in the DOCSIS Data Pseudowire.

The upstream MAC preprocessor may also extract burst data received in IUC 3 (initial maintenance) and IUC4 (station maintenance) and place them into a UEPI RNG-REQ Pseudowire. If the RPD extracts the messages from IUC 3 and IUC 4, they will not be included in the UEPI DOCSIS Data Pseudowire.

The upstream MAC preprocessor in the RPD always extracts standalone request messages and copies piggyback requests from the DOCSIS upstream frames or segments on all available channels and encodes them into one or more UEPI Request Pseudowire(s). Each request is stored in a Request Block and is tagged with the UEPI session ID from the UEPI Data Pseudowire associated with the OFDMA channel or SC-QAM Logical Channel from which it was received.

The RPD may contain a spectrum management function that permits a Spectrum Management Entity to extract measurement data from the RPD. This measurement data is carried over a dedicated UEPI SpecMan (Spectrum Management) Pseudowire.

6 PHYSICAL LAYER REQUIREMENTS

All physical layer requirements from [DRFI] apply to the Remote PHY system, except as noted below. This section also introduces additional physical layer requirements.

6.1 Upstream PHY

This section applies to the upstream PHY component as measured from the RF interface to the UEPI reference point.

6.1.1 Latency

The latency of the RPD is composed of two elements:

- DOCSIS PHY latency
- DOCSIS MAC preprocessor latency

The nominal DOCSIS PHY latency is provided in Table 1.

Table 1 - Nominal DOCSIS PHY Latency

Case	Description	Latency Formula	Examples	
			Variables	Results
1	SCDMA	$3 * (\text{frame_duration})$ [K can go as high as 32]	1.28 MBaud, K=16 2.56 MBaud, K=8 5.12 MBaud, K=4	4.8 msec 1.2 msec 300 µsec
2	TDMA interleaver off	$[(400 + (\text{FEC_N} * 8)) / (\text{bits_per_symbol})] * T_sym$	QPSK, 1.28 MBaud, FEC_N=255 16-QAM, 2.56 MBaud, FEC_N=140 64-QAM, 5.12 MBaud, FEC_N=18	1100 µsec 265 µsec 82 µsec
3	TDMA interleaver on	$[400 + (\text{IL_Block_size} * 8)) / (\text{bits_per_symbol})] * T_sym$ [IL_B can go as high as 2048]	QPSK, 1.28 MBaud, IL_B=1024 16-QAM, 2.56 MBaud, IL_B=512 64-QAM, 5.12 MBaud, IL_B=36	3.5 msec 556 µsec 87 µsec
4	OFDMA	$2 * (\text{frame_duration})$	20 usec symbol, 0.9375 usec cyclic prefix, K=6 40 usec symbol, 6.25 usec cyclic prefix, K=18	251 usec 1.67 msec

The maximum and minimum DOCSIS MAC preprocessor latency is provided in Table 2.

Table 2 - Maximum DOCSIS MAC Preprocessor Latency

Case	Description	Maximum Latency	Minimum Latency
A	Data PW RNG-REQ PW	1 ms	0 ms
B	Request PW	250 µs + aggregation_interval	0 ms

Latency is defined as the absolute difference in time from when the last bit of a reference event (such as a REQ message) enters the RPD RF Interface to the time that the same bit exits the RPD network interface. The last bit in a reference event is used since the network port is faster than the RF port, and thus it will minimize the impact that different modulation and symbol rates have on this measurement.

The RPD MUST NOT exceed a maximum latency of 110% of the combination of the nominal DOCSIS PHY latency and the maximum DOCSIS MAC preprocessor latency.

The Scheduling Entity in the CCAP Core MUST provide a MAP to the RPD in advance, by an amount of time equal to the amount of time that the DOCSIS CM expects to receive a MAP message in advance.

The latency of the RPD for the UEPI SpecMan pseudowire is not specified.

The RPD MUST forward isolated bursts from the DOCSIS RF interface to each UEPI pseudowire with a latency of less than 110% of the combination of the nominal DOCSIS PHY latency and the maximum DOCSIS MAC preprocessor latency as described in Table 1 - Nominal DOCSIS PHY Latency and Table 2 - Maximum DOCSIS MAC Preprocessor Latency. Isolated bursts are spaced such that when the preceding latency requirement is met, the RPD will complete processing and transmission of the current burst before the arrival of the next burst.

In operation, if any burst, such as a burst containing an IUC request, is received by the RPD immediately after another burst, the second burst might be delayed up to the maximum processing time (as described in Table 1) of the first burst.

6.1.2 Skew

Skew is defined as the difference between the maximum latency and the minimum latency through the RPD, as measured from two reference bits on two separate RF inputs to the same bits on the network interface.

The skew of the RPD comprises two elements:

- Difference in the DOCSIS PHY latency
- Difference in the DOCSIS MAC preprocessor latency

The difference in the DOCSIS PHY latencies is provided in Table 1. The difference in the MAC preprocessor latencies is provided in Table 2. The RPD MUST NOT exceed a maximum skew of 110% of the sum of the difference in the nominal latencies of the two PHY channels being measured and the difference between the maximum latency and minimum latency of the MAC preprocessor.

7 R-UEPI CONTROL PLANE

UEPI recognizes two fundamental topologies:

- The UEPI Embedded Architecture in which the MAC Entity and the PHY Entity are located within the same assembly. In this architecture, an informal pseudowire with a forwarding plane but no formal signaling protocol is required between entities. Control plane functions such as pseudowire address assignment or QoS configuration can be performed using direct register access by a local processor or through a more formal protocol.
- The R-UEPI System Architecture in which the MAC Entity and the PHY Entity are located in physically different assemblies. In this architecture, a formal pseudowire with a forwarding plane and a control plane are used to communicate between entities. For purposes of the current version of this specification, the MAC Entity is considered to be part of a CCAP Core and the PHY Entity is considered to be part of an RPD.

The R-UEPI control plane is derived from the [R-DEPI] control plane and is described in a separate specification (see [R-DEPI]).

8 UEPI FORWARDING PLANE

The R-UEPI forwarding plane is generally compatible with [R-DEPI] with the following notable exceptions:

- A UDP header is not used;
- The D-MPT pseudowire is not used;
- The PSP pseudowire is used with enhancements.

All reserved fields **MUST** be set to zero by the sending entity (the RPD). All reserved fields **MUST** be ignored by the receiving entity (the CCAP Core). While this specification illustrates packet formats with examples including IPv4 header format, the use of IPv6 headers is also permitted.

8.1 UEPI Transport Packet Format

This section describes the various fields of the L2TPv3 packet as it applies to UEPI. Protocol fields that are not UEPI specific (IPv4 for example) are illustrated here for reference only. Compliance to these other protocol layers should be designed with the appropriate specifications in mind.

A UEPI packet over IPv4 is shown in Figure 4. The specific fields are explained below.

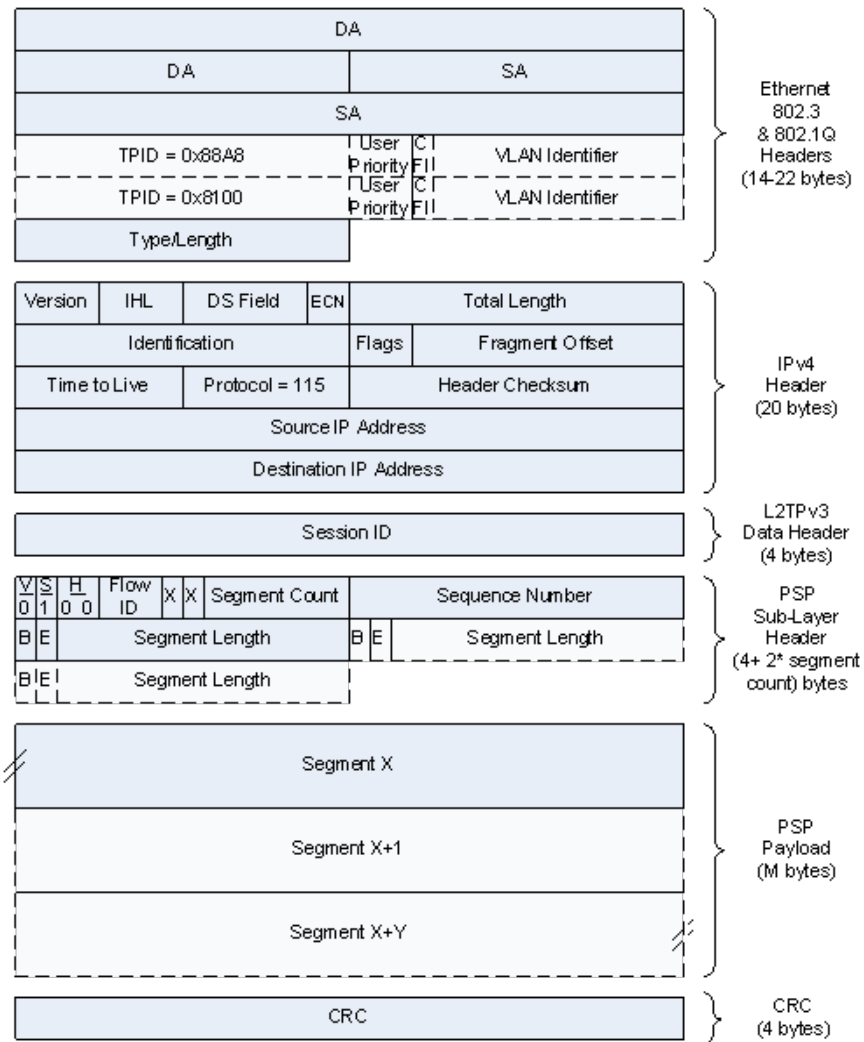

Figure 4 - UEPI IPv4 Packet with L2TPv3 Encapsulation

8.1.1 Ethernet 802.3 Header

The Ethernet header is defined by [IEEE 802.3]. The Ethernet Destination Address is an individual address. The Ethernet Destination Address may be locally or globally administered.

Upon transmission of this frame by the source entity, the Ethernet Destination Address will be the Ethernet address of the destination entity or of the next hop router. Upon reception of this frame by the destination entity, the Ethernet Source Address will be the Ethernet address of the output port of the source entity or of the previous hop router. The Ethertype field will be 0x0800 if the next field is IPv4 or 0x86DD if the next field is IPv6.

If the networking interface is Ethernet, the CCAP Core MUST support the Ethernet header. If the networking interface is Ethernet, the RPD MUST support the Ethernet header. If another physical layer interface is used instead of Ethernet, then the Ethernet headers are replaced with the header format pertaining to that physical layer.

8.1.2 Ethernet 802.1q Header

The Ethernet 802.1q header is defined by [IEEE 802.1q]. This field is optional. The field consists of a 2-byte Tag Protocol Identifier (TPID) followed by a 2-byte Tag Control Information (TCI). The TCI field provides 3 bits of frame prioritization and 12 bits of VLAN support. These headers are inserted after the Ethernet Source Address. This has the effect of maintaining the original Ethernet [IEEE 802.3] Type/Length field.

If one instance of this field is used, the TPID value is set to 0x8100. If two instances of this field are used, the first TPID is 0x88A8 and the second TPID is 0x8100.

The CCAP Core MAY support the Ethernet 802.1q header. The RPD MAY support the Ethernet 802.1q header.

8.1.3 IPv4 Header

The IPv4 header is defined by [RFC 791]. The IP Source Address is the IP address of the source entity. The IP Destination Address is the IP address of the destination entity.

For implementation considerations and for coexistence with network policies that are not amenable to IPv4 fragmentation, MAC and PHY entities are not required to perform IP reassembly. The RPD MUST NOT use IP fragmentation. The RPD MUST assert the IP DF (Don't Fragment) bit.

The CCAP Core MUST NOT use IP fragmentation. The CCAP Core MUST assert the IP DF (Don't Fragment) bit.

The CCAP Core MUST support a configurable 6-bit Differentiated Services Code Point (DSCP). The RPD MUST support a configurable 6-bit DSCP. The DSCP is located in the DS Field and is defined by [RFC 2474].

The CCAP Core MUST support the IPv4 header. The RPD MUST support the IPv4 header.

8.1.4 IPv6 Header

The IPv6 header is defined by [RFC 2460]. A typical IPv6 header is shown in Figure 5. The IPv6 header can be used in place of the IPv4 header.

The CCAP Core SHOULD support the IPv6 header. The RPD SHOULD support the IPv6 header. There is no requirement to support IPv6 extension headers.

The CCAP Core egress MUST support a configurable 6-bit Differentiated Services Code Point (DSCP). The RPD egress MUST support a configurable 6-bit DSCP. The DSCP is located inside the Traffic Class field and is defined by [RFC 2474].

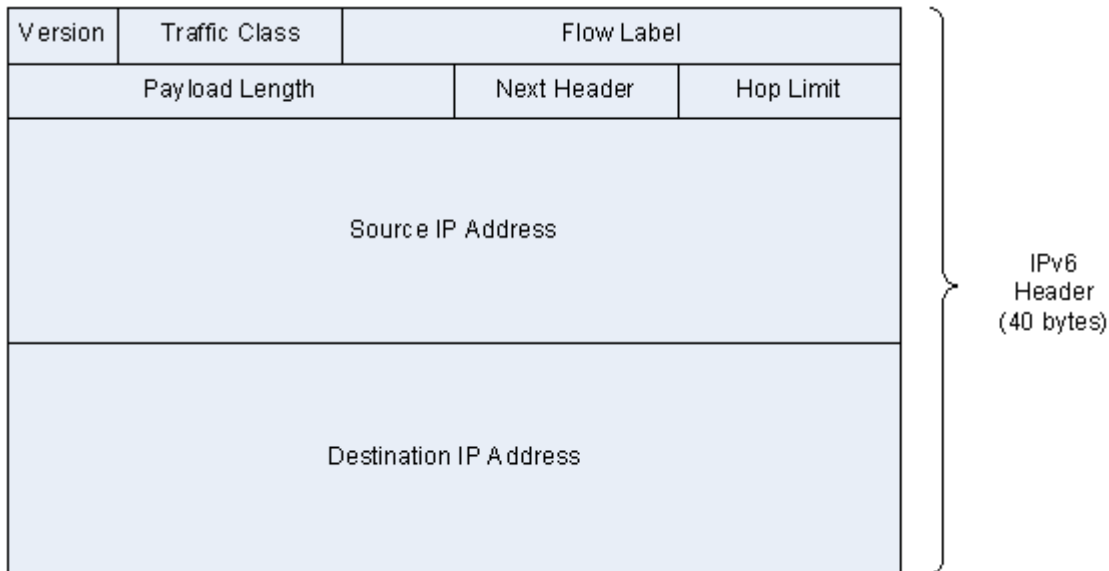

Figure 5 - Composition of an IPv6 Header

8.1.5 L2TPv3 Session ID Header

This field contains the non-null L2TPv3 32-bit session identifier. The UEPI control plane determines this value.

The CCAP Core MUST support the L2TPv3 Session ID.

The RPD MUST support the L2TPv3 Session ID.

The optional L2TPv3 cookie field is not used for UEPI because it is presumed that UEPI will be deployed over a secure transport or in a secure environment.

8.1.6 PSP Sub-Layer Header

R-UEPI uses the Legacy PSP Sublayer header, a type of PSP sublayer header no longer used in R-DEPI. The main format difference between the Legacy PSP Sublayer header and the PSP Sublayer header defined in the [R-DEPI] specification is the expansion of the segment table from 16-bits to 32-bits. The 32-bit long entries of the segment table carry additional information such as channel identifier, per channel sequence number, and OFDM profile information.

Figure 6 shows the format of the Legacy PSP Sublayer header and payload which was defined in the [R-DEPI] specification.

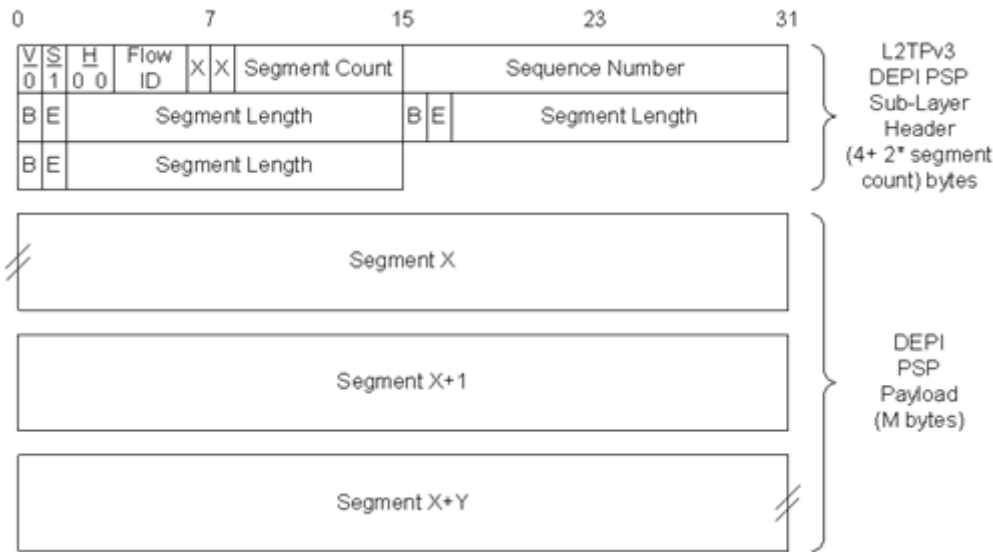

Figure 6 - Legacy PSP Sublayer Header and Payload

Table 3 below describes the composition of the PSP sublayer header and its associated fields.

Table 3 - Composition of a PSP Sublayer Header

Field	Size	Function
V	1 bit	VCCV bit. Set to 0. Reserved for compatibility with [VCCV].
S	1 bit	Sequence bit. Set to 1 to indicate that the sequence number field is valid. Set to 0 to indicate that the sequence field is not valid.
H	2 bits	Extended Header bits. Set to '00' to indicate a UEPI sub-layer header that matches the current active pseudowire type.
Flow ID	3 bits	Flow Identifier
X	1 bit	Reserved field.
Segment Count	7 bits	This is the number of segments in the UEPI PSP Payload, and this is also the number of 2-byte entries in the PSP Segment Table.
Sequence Number	2 bytes	The sequence number increments by one for each data packet sent and may be used by the receiver to detect packet loss. The initial value of the sequence number SHOULD be random (unpredictable).
B	1 bit	Begin bit. Set to a 1 to indicate that the PSP Segment contains the beginning of a transmission unit. Otherwise, set to 0.
E	1 bit	End bit. Set to a 1 to indicate that the PSP Segment contains the end of a transmission unit. Otherwise, set to 0.
Segment Length	14 bits	Length of PSP Segment in bytes.

Refer to Section 9.3 for information on the proper use of the Flow ID and Sequence Number fields. Begin and End bits refer to the beginning and ending of a UEPI Transmission Unit that is defined independently for each UEPI pseudowire.

8.1.7 PSP Payload

The format of the message payload is implicitly defined by the choice of UEPI session ID. Both the CCAP Core and the RPD entities interpret the message payload in a similar manner. The expected message payload type is established during the session initialization.

8.1.8 CRC

The CRC is CRC-32 and is defined by [IEEE 802.3].

The CCAP Core MUST support the CRC field. The RPD MUST support the CRC field.

8.2 UEPI Pseudowires

UEPI uses a series of pseudowires to exchange specific information between the entities. All UEPI pseudowires use the PSP pseudowire format. However, they differ in the way they use the PSP Payload.

PSP defines a mechanism where one or more packets can be grouped together into a byte stream. This byte stream is then broken up into segments. One or more segments are then sent in a PSP packet. The PSP sub-layer header contains a segment table that cross-references all the segments. One of the attributes of PSP is that it will generally be able to fit its content into the MTU of the network it is passing over without using IP fragmentation. UEPI builds upon PSP and further defines specific uses for different segments.

A summary of the types of UEPI pseudowires and their characteristics are shown in Table 4.

Table 4 - UEPI Pseudowire Summary

Pseudo wire Type	Channel Type	Channel Grouping	PSP Fragmentation Support	PSP Concatenation Support
Data PW	SC-QAM	LC	No for UEPI Header Segment. Yes for UEPI Payload Segment. No for UEPI Trailer Segment	No for SC-QAM logical channel
	OFDMA	Chan		Optional for OFDMA channel
RNG-REQ PW	SC-QAM	LC	No	No
	OFDMA	Chan		
REQ PW	SC-QAM	Group	No	No, although REQs from within a SC-QAM LC or OFDMA channel can be aggregated within a single PSP segment.
	OFDMA	Chan		
MAP PW	SC-QAM	LC	No	No
	OFDMA	Chan		
Probe PW	OFDMA	Chan	Yes	No
SpecMan PW	SCQAM	Group	Yes	No
PNM PW	OFDMA	Chan/Group	Yes	Yes
EC-REQ PW	FDX-OFDMA	Group	No	No

8.2.1 UEPI Data Pseudowire Format for an SC-QAM Channel

For an SC-QAM channel, the UEPI Data Pseudowire Transmission Unit consists of a UEPI Header Segment, zero or more UEPI Payload Segments, and a UEPI Trailer Segment. UEPI places a received data burst into a PSP Pseudowire as shown in Figure 7.

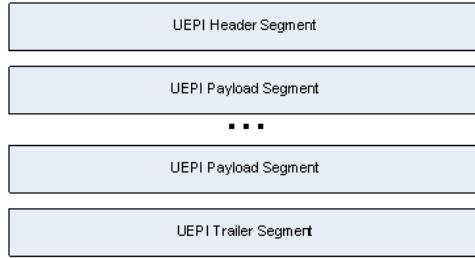

Figure 7 - UEPI Data Pseudowire Transmission Unit for an SC-QAM Channel

1. A UEPI Header Segment is placed into the PSP beginning Segment. This segment has the B bit asserted in the PSP Segment Table. No other data is placed into this beginning segment. This segment is the first segment in the first packet of a UEPI transmission unit. The UEPI Header Segment **MUST** be present for a UEPI Data Pseudowire Transmission Unit.
2. A UEPI Payload Segment corresponds to a PSP middle Segment. This segment has the B bit and E bit de-asserted in the PSP Segment Table. A UEPI Payload Segment contains received burst data (if any). Received burst data may be spread across one or more UEPI Payload Segments in the order that it was received. The received burst data may be fragmented at any byte boundary. In the case of a No Burst Transmission Unit, the UEPI header segment will have both the B and E bits asserted.
3. A UEPI Trailer Segment is placed into the PSP ending segment. This segment has the E bit asserted in the PSP Segment Table. No other data is placed into this ending segment. This segment is the last segment in the last packet of a UEPI transmission unit. The UEPI Trailer Segment **MUST** be present for a UEPI Data Pseudowire Transmission Unit.

The segments of a UEPI Transmission Unit may be spread across one or more UEPI packets.

One PSP Pseudowire is set up between each logical channel of the RPD and each channel of the CCAP Core. That pseudowire is identified by a unique session ID that is assigned by the CCAP Core (since it is the receiver of the UEPI packet).

Each UEPI Data Pseudowire **MUST** contain only DOCSIS bursts that originated from that logical channel.

On UEPI Data Pseudowires, the RPD **MUST** be able to spread a UEPI Transmission Unit across multiple PSP packets (PSP fragmentation). On UEPI Data Pseudowires, the RPD **MUST NOT** combine multiple UEPI Transmission Units within a PSP packet (PSP concatenation). Note that a DOCSIS burst could be as long as 24 kilobytes. Thus, PSP allows the DOCSIS burst size and the UEPI Ethernet MTU to be independently managed.

The CCAP Core **MAY** extract and process piggyback requests that appear in the header of a DOCSIS burst that was transmitted as part of a fragmented concatenation. The CCAP Core **MUST** ignore all other piggyback requests and standalone requests.

The CCAP Core is responsible for checking the DOCSIS HCS and CRC for all data and ranging bursts received on SC-QAM channels. The RPD does not report DOCSIS HCS or CRC status for these bursts.

8.2.1.1 UEPI Header Segment for an SC-QAM Channel

The UEPI Header Segment has the format shown in Figure 8.

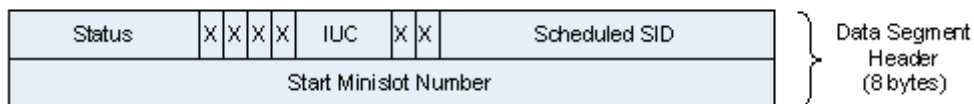

Figure 8 - UEPI Header Segment Format for an SC-QAM Channel

The fields of the UEPI Header Segment have the functions defined in Table 5.

Table 5 - UEPI Header Segment for an SC-QAM Channel

Field	Size	Function
Status	8 bits	Bit 7:6 – Header Version Number 00 = Version 1 01, 10, 11: Reserved Bit 5 – UEPI Payload Segment is not present (a No Burst event) 0 = UEPI Payload Segment is present. 1 = UEPI Payload Segment is not present. Bits 4:0 – Reserved
X	1 bit	Reserved field.
IUC	4 bits	This is the IUC that the message was received in.
Scheduled SID	14 bits	The SID used in the MAP to grant bandwidth for the transmit opportunity associated with this UEPI Header Segment.
Start Minislot	32 bits	This is the minislot number that corresponds to the start of the transmit opportunity.

Note that the Logical Channel number, the Physical Port, and the MAC Domain of the data packet are associated uniquely with the Session ID and do not need to be included on a per packet basis.

A No Burst event is defined as an event when an upstream transmission has been scheduled, but no discernable payload has been received, due to nothing being transmitted by the CM, an upstream collision event, or some other HFC event, such as noise interference which would render the upstream transmission as invalid. A No Burst Event Transmission Unit consists of a UEPI Header Segment and a UEPI Trailer Segment. The No Burst Event Transmission Unit does not contain a UEPI Payload Segment. A No Burst Event Transmission Unit is sent in response to certain No Burst events as described in Section 9.1.

8.2.1.2 UEPI Trailer Segment for an SC-QAM Channel

The UEPI Trailer Segment has the format shown in Figure 9.

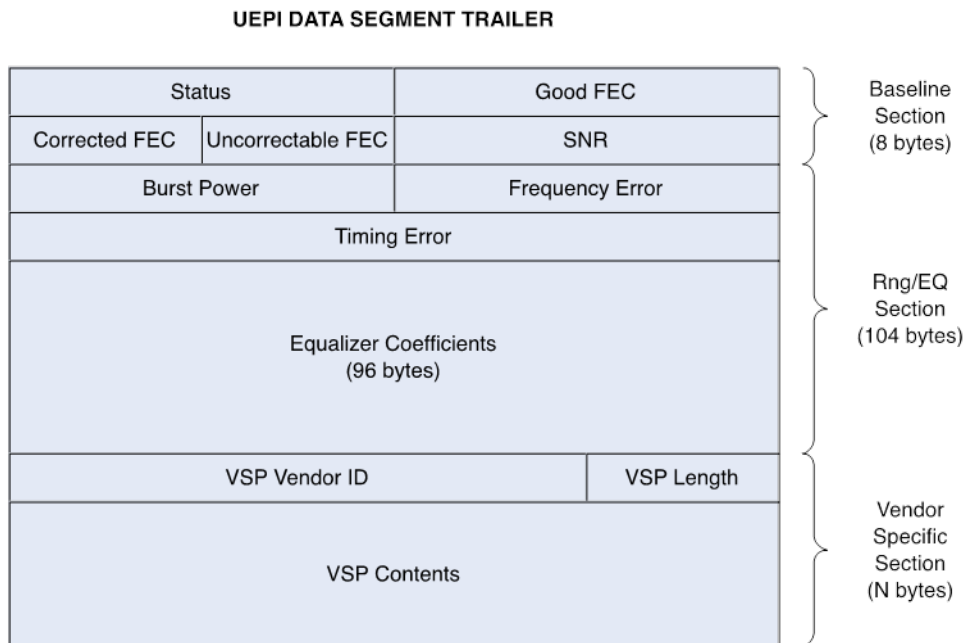

Figure 9 - UEPI Trailer Segment Format for an SC-QAM Channel

The fields of the UEPI Trailer Segment for an SC-QAM channel are described in Table 6.

Table 6 - UEPI Trailer Segment for an SC-QAM Channel

Field	Size	Function
Status	2 bytes	Bit 15:14 – Trailer Version Number 00 = Version 1 01, 10, 11: Reserved Bit 13 – Reserved Bit 12 – Ranging required *(optional bit) 0 = No ranging issue detected 1 = Ranging process required Bit 11 – Long-term SNR low* 0 = Long-term SNR above threshold 1 = Long-term SNR below threshold Bit 10 – Internal PHY error* 0 = No internal PHY error 1 = Internal PHY error detected Bit 9 – High energy* 0 = Burst power below high-energy threshold 1 = Burst power above high-energy threshold Bit 8 – Low energy* 0 = Burst power above low-energy threshold 1 = Burst power below low-energy threshold Bit 7 – Reserved Bit 6 – EQ_suppression 0 = No suppression of EQ Coefficient when RngEQ_Present (Bit1) is set to 1. 1 = Suppress EQ Coefficient when RngEQ_Present is set to 1. Bits 5:4 - Reserved Bit 3 – FEC_valid: 0 = Good, corrected, and uncorrectable FEC count fields are not valid. 1 = Good, corrected, and uncorrectable FEC count fields are valid. Bit 2 – SNR_valid: 0 = Burst payload SNR field is not valid 1 = Burst payload SNR field is valid Bit 1 – RngEQ_Present: 0 = Burst power, frequency error, timing error, and equalizer coefficient fields are not present. 1 = Burst power, frequency error, timing error, and equalizer coefficient fields are present. Bit 0 – VendorField_Present: 0 = Vendor-specific field is not present 1 = Vendor-specific field is present
Good FEC	2 bytes	The number of good FEC blocks received in the burst. This field is always present, but is not valid unless the FEC_valid bit is set.
Corrected FEC	1 byte	The number of FEC blocks received in the burst which had errors that were corrected. This field is always present, but is not valid unless the FEC_valid bit is set. (See Table Note 1)
Uncorrectable FEC	1 byte	The number of uncorrectable FEC blocks received in the burst. This count MUST saturate at 255. This field is always present, but is not valid unless the FEC_valid bit is set. (See Table Note 2)
SNR	2 bytes	Burst payload SNR, reported as normalized slicer error power over the payload of the burst. Expressed in unsigned # (0.16) format representing values between 0 and 1, where normalized QPSK power is 0.5. This field is always present, but is not valid unless the SNR_valid bit is set.
Power	2 bytes	Measured burst power, reported as a normalized RMS power (Gain) between 0 and 4, expressed in unsigned # (2.14) format, where expected power level** = 1.0. The bytes of this field are present only if the RngEQ_Present bit is set.

Field	Size	Function
Frequency Error	2 bytes	Measured carrier frequency error, expressed as a signed integer with lsb resolution corresponding to 2.4414 Hz. The bytes of this field are present only if the RngEQ_Present bit is set.
Timing Error	4 bytes	Measured timing error, expressed as a signed integer with lsb resolution corresponding to 0.381 nsec. The bytes of this field are present only if the RngEQ_Present bit is set.
Equalizer Coefficients	96 bytes	Complex coefficients for pre-equalization as determined by the PHY based on this burst. The bytes of this field are present only if the RngEQ_Present bit is set.
Vendor-specific Vendor ID	3 bytes	IANA-assigned OUI for vendor. The bytes of this field are present only if the VendorField_Present bit is set.
Vendor-specific field length	1 byte	Indicates the length in bytes of the vendor-specific field. The bytes of this field are present only if the VendorField_Present bit is set. (See Table Note 3)
Vendor-specific field contents	N bytes	Vendor-specific field contents of length given in Vendor-specific field length. The bytes of this field are present only if the VendorField_Present bit is set. (See Table Note 4)

Table Notes:

* The status bit behavior is intended to be Vendor-specific and detailed requirements for the behavior are outside the scope of this document.

** The expected power level for the channel is configured through RCP attributes BaseTargetRxPower (TLV 98.3) and TargetRxPowerAdjust (TLV 65.9).

1. The Corrected FEC count of the UEPI Trailer Segment for an SC-QAM channel MUST saturate at 255.
2. The Uncorrectable FEC count of the UEPI Trailer Segment for an SC-QAM channel MUST saturate at 255.
3. The value of the Vendor-specific field length count of the UEPI Trailer Segment for an SC-QAM channel field MUST NOT exceed 32.
4. The length of the Vendor-specific field content count of the UEPI Trailer Segment for an SC-QAM channel field MUST be equal to the number of bytes indicated in the "Vendor-specific field length" field.

8.2.2 UEPI Data Pseudowire Format for an OFDMA Channel

For an OFDMA channel, the UEPI Data Pseudowire consists of two types of Transmission Units: Payload and Trailer. The Payload Transmission Unit consists of UEPI Header Segment, and zero or more UEPI Payload Segments. The Trailer Transmission Unit contains a single UEPI Trailer Segment, as shown in Figure 10. Separated transmissions of the payload and trailer of a received data burst allow the data payload and the trailer statistics to be handled by independent-hardware-logic on both PHY and MAC.



Figure 10 - UEPI Data Pseudowire Payload and Trailer Transmission Units for an OFDMA Channel

UEPI places a received data burst into a PSP Pseudowire on an OFDMA channel using the following procedure:

1. A UEPI Header Segment is placed into the PSP beginning Segment. This segment has the B bit asserted in the PSP Segment Table. No other data is placed into this beginning segment. This segment is the first segment in

- the first packet of a UEPI Payload transmission unit. The UEPI Header Segment **MUST** be present for a UEPI Data Pseudowire Payload Transmission Unit.
2. A UEPI Payload Segment corresponds to a PSP middle Segment or a PSP ending Segment. A UEPI Payload Segment contains received burst data (if any). Received burst data can be spread across one or more UEPI Payload Segments in the order that it was received. The received burst data can be fragmented at any byte boundary. A UEPI Payload segment has the B bit and E bit de-asserted in the PSP Segment Table, unless it is the last Payload segment, which has the E bit asserted in the PSP Segment Table. In the case of a No Burst Transmission Unit, the UEPI header segment will have both the B and E bits asserted.
 3. The UEPI Trailer information is placed into a single segment PSP Transmission Unit. This segment has both the B and E bit asserted in the PSP Segment Table. The Trailer Transmission Unit is independent from the Payload Transmission Unit, and does not have to be sent immediately after the Payload Transmission Unit of the same data burst.

The segments of a UEPI Data Payload Transmission Unit can be spread across one or more UEPI packets.

One PSP Pseudowire is set up between each channel of the RPD and each channel of the CCAP Core. That pseudowire is identified by a unique session ID that is assigned by the CCAP Core (since it is the receiver of the UEPI packet).

Each UEPI Data Pseudowire **MUST** contain only DOCSIS bursts that originated from that channel.

When using UEPI Data Pseudowires, the RPD **MUST** be able to spread a UEPI Payload Transmission Unit across multiple PSP packets (PSP fragmentation). A UEPI Data Trailer Transmission Unit may be sent after a UEPI Data Payload Transmission Unit in the same PSP packet.

When using UEPI Data Pseudowires for an OFDMA channel, the RPD may also combine multiple UEPI Payload Transmission Units and/or multiple Data Trailer Transmission Units within a PSP packet (PSP concatenation). The level of concatenations, in terms of the maximum number of Payload Transmission Units and the maximum Trailer transmission units that may be present in the same PSP packet, **MUST** be set up through the UEPI control plane for compatibility between the MAC and the RPD. Such concatenation is not allowed for UEPI pseudowires for SC-QAM channels. Note that a DOCSIS burst could be as long as 24 kilobytes. Thus, PSP allows the DOCSIS burst size and the UEPI Ethernet MTU to be independently managed.

The CCAP Core **MAY** extract and process piggyback requests that appear in the header of a DOCSIS burst that was transmitted as part of a fragmented concatenation. The CCAP Core **MUST** ignore all other piggyback requests and standalone requests.

8.2.2.1 UEPI Data Header Segment for an OFDMA Channel

The UEPI Header Segment for the UEPI Data Pseudowire for an OFDMA channel has the format shown in Figure 11.

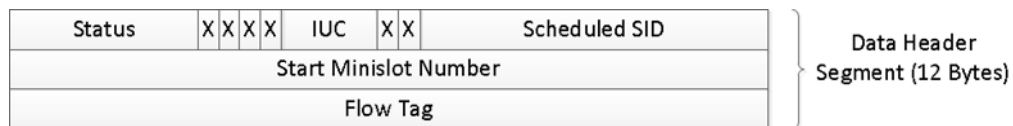

Figure 11 - UEPI Header Segment Format for an OFDMA Channel

The fields of the UEPI Header Segment for OFDMA channels have the functions defined in Table 7.

Table 7 - UEPI Header Segment for an OFDMA Channel

Field	Size	Function
Status	8 bits	Bit 7:6 – Header Version Number 00 = Version 1 01, 10, 11: Reserved Bit 5 – Transmit Unit Type 0 = UEPI Data Payload Transmission Unit type 1 = UEPI Data Trailer Transmission Unit type Bit 4 – UEPI Payload Segment not present (No Burst event) 0 = UEPI Payload Segment is present. 1 = UEPI Payload Segment is not present. Bit 3 – UEPI Data Payload Transmission Concatenation Enabled 0 = Payload concatenation is not enabled 1 = Payload concatenation is enabled Bit 2 – Segment HCS Flag 0 = Segment HCS check pass 1 = Segment HCS check fail Bit 1 – Flow Tag field is valid 0 = Flow tag is not valid 1 = Flow tag is valid Bit 0 – Reserved
X	1 bit	Reserved field.
IUC	4 bits	This is the IUC that the message was received in.
Scheduled SID	14 bits	The SID used in the MAP to grant bandwidth for the transmit opportunity associated with this UEPI Header Segment.
Start Minislot	32 bits	This is the minislot number that corresponds to the start of the transmit opportunity.
Flow Tag	32 bits	Hardware resource tag assigned by the CCAP Core to the scheduled SID.

Note that the Channel number, the Physical Port, and the MAC Domain of the data packet are associated uniquely with the Session ID and do not need be included on a per packet basis.

A No Burst event is defined as an event when an upstream transmission has been scheduled, but no discernable payload has been received, due to nothing being transmitted by the CM, an upstream collision event, or some other HFC event such as noise interference which would render the upstream transmission as invalid. A No Burst Event Transmission Unit consists of a UEPI Header Segment and a UEPI Trailer Segment. The No Burst Event Transmission Unit does not contain a UEPI Payload Segment. A No Burst Event Transmission Unit is sent in response to certain No Burst events as described in Section 9.1.

8.2.2.2 UEPI Data Trailer Segment for an OFDMA Channel

The UEPI Trailer Segment for the UEPI Data Pseudowire for OFDMA channel has the format shown in Figure 12.

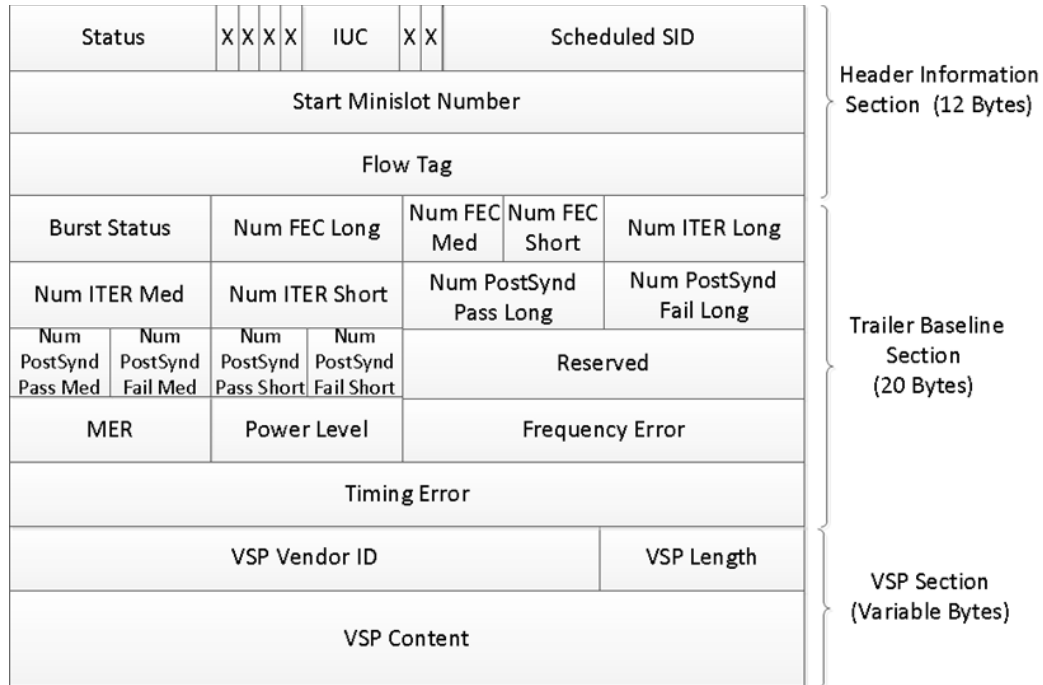

Figure 12 - UEPI Trailer Segment Format

The fields of the UEPI Trailer Segment for OFDMA channel are described in Table 8.

Table 8 - UEPI Trailer Segment for an OFDMA Channel

Field	Size	Function
Status	8 bits	Bit 7:6 – Header Version Number 00 = Version 1 01, 10, 11: Reserved Bit 5 – Transmit Unit Type 0 = UEPI Data Payload Transmission Unit type 1 = UEPI Data Trailer Transmission Unit type Bit 4 – UEPI Payload Segment not present (No Burst event) 0 = UEPI Payload Segment is present. 1 = UEPI Payload Segment is not present. Bit 3 – UEPI Trailer Transmission Concatenation Enabled 0 = Trailer concatenation is not enabled 1 = Trailer concatenation is enabled Bit 2 – Reserved Bit 1 – Flow Tag field is valid 0 = Flow tag is not valid 1 = Flow tag is valid Bit 0 – Vendor Specific Field present 0 = Vendor Specific Field is not present 1 = Vendor Specific Field is present
X	1 bit	Reserved field.
IUC	4 bits	This is the IUC that the message was received in.
Scheduled SID	14 bits	The SID used in the MAP to grant bandwidth for the transmit opportunity associated with this UEPI Header Segment.
Start Minislot	32 bits	This is the minislot number that corresponds to the start of the transmit opportunity.
Flow Tag	32 bits	Hardware resource tag assigned by the CCAP Core to the scheduled SID.

Field	Size	Function
Burst Status	8 bits	Bit 7 -- High energy* 0 = Burst power below high-energy threshold 1 = Burst power above high-energy threshold Bit 6 – Low energy* 0 = Burst power above low-energy threshold 1 = Burst power below low-energy threshold Bit 5 – Probing Required* 0 = Probing is not required 1 = Probing is required Bit 4 – Internal PHY Error field is valid* 0 = Internal PHY Error field is not valid 1 = Internal PHY Error field is valid Bit 3 – Internal PHY Error* 0 = Internal PHY Error detected 1 = Internal PHY Error not detected Bit 2 – Timing Error field is valid 0 = Timing Error field is not valid 1 = Timing Error field is valid Bit 1 – Power Error field is valid 0 = Power Error field is not valid 1 = Power Error field is valid Bit 0 = Frequency Error field is valid 0 = Frequency Error field is not valid 1 = Frequency Error field is valid
Num FEC – Long	8	The number of long codewords received in this burst.
Num FEC – Med	4	The number of medium codewords received in this burst.
Num FEC – Short	4	The number of short codewords received in this burst.
Num Iterations – Long	8	The average number of decoding iterations of all long codewords received in this burst.
Num Iterations – Med	8	The average number of decoding iterations of all medium codewords received in this burst.
Num Iterations – Short	8	The average number of decoding iterations of all short codewords received in this burst.
Num Post Syndrome Pass – Long	8	The number of long codewords that failed pre-decoding syndrome check, but passed post-decoding syndrome check in this burst.
Num Post Syndrome Fail – Long	8	The number of long codewords that failed post-decoding syndrome check in this burst.
Num Post Syndrome Pass – Med	4	The number of medium codewords that failed pre-decoding syndrome check, but passed post-decoding syndrome check in this burst.
Num Post Syndrome Fail – Med	4	The number of medium codewords that failed post-decoding syndrome check in this burst.
Num Post Syndrome Pass – Short	4	The number of short codewords that failed pre-decoding syndrome check, but passed post-decoding syndrome check in this burst.
Num Post Syndrome Fail – Short	4	The number of short codewords that failed post-decoding syndrome check in this burst.
Reserved	16	
MER	8	Measured average modulation error ratio, unsigned 8 bits in 0.25 dB unit.
Power Error	8	Measured receive burst power relative to target burst power (defined as received power – target power**), signed 8 bits in 0.25 dB unit.
Frequency Error	16	Measured receive frequency error, signed 16 bits in Hz unit.
Timing Error	32	Measured receive timing relative to target upstream frame start time (defined as measured arrival time – target arrival time), signed 32 bits, 1/204.8 MHz units.
Vendor-specific field Vendor ID	3 bytes	IANA-assigned OUI for vendor. The bytes of this field are present only if the VendorField_Present bit is set.

Field	Size	Function
Vendor-specific field length	1 byte	Indicates the length in bytes of the vendor-specific field. The bits of this field are present only if the VendorField_Present bit is set. (See Note 1 below)
Vendor-specific field contents	N bytes	Vendor-specific field contents of length given in "Vendor-specific field length." The bytes of this field are present only if the VendorField_Present bit is set. (See Note 2 below)

Table Notes:

* The status bit behavior is intended to be Vendor-Specific and detailed requirements for the behavior is outside the scope of this document.

** The expected power level for the channel is configured through RCP attributes BaseTargetRxPower (TLV 98.3) and TargetRxPowerAdjust (TLV 66.13).

1. The value of the Vendor-specific length of the UEPI Trailer Segment for OFDMA channel field MUST NOT exceed 32.
2. The length of the Vendor-specific field contents of the UEPI Trailer Segment for OFDMA channel field MUST be equal to the number of bytes indicated in the "Vendor-specific field length" field.

8.2.3 UEPI RNG-REQ Pseudowire Format for an SC-QAM Channel

The RPD MUST support UEPI RNG-REQ pseudowires for SC-QAM channels.

This specification defines two options for transmission of Range Request messages received by the RPD on SC-QAM channels. The first option permits the RPD to send these messages on the UEPI Data Pseudowire. The second option is to send Range Request messages on a dedicated pseudowire. The CCAP Core configures the RPD for one of these options via the GCP control plane. Additional information about configuring the RPD's operation on RNG-REQ Pseudowire for SC-QAM channels can be found in Annex B of [R-PHY].

If the second option is enabled, the CCAP Core establishes a separate Pseudowire for RNG-REQs, one per logical channel, each with a unique session ID. When the CCAP Core configures the RPD for operation without the RNG-REQ Pseudowire, then the CCAP Core MUST NOT establish the RNG-REQ Pseudowires. When configured to use the RNG-REQ Pseudowires for SC-QAM channels, the RPD MUST use the RNG-REQ Pseudowire for the logical channel to send all bursts received in IUCs 3 or 4 on that logical channel.

When configured to use the RNG-REQ Pseudowires for SC-QAM channels, the RPD MUST NOT send ranging bursts on the Data Pseudowire.

When configured not to use the RNG-REQ Pseudowire, the RPD MUST send all bursts received in IUCs 3 or 4 on the Data Pseudowire.

The UEPI RNG-REQ Pseudowire Transmission Unit for SC-QAM channel is the same as that of the UEPI DataPseudowire Transmission Unit.

On UEPI RNG-REQ Pseudowires for SC-QAM channels, the RPD MUST NOT spread a UEPI Transmission Unit across multiple PSP packets (PSP fragmentation). On UEPI RNG-REQ Pseudowires for SC-QAM channels, the RPD MUST NOT combine multiple UEPI Transmission Units within a PSP packet (PSP concatenation).

8.2.4 UEPI RNG-REQ Pseudowire Format for an OFDMA Channel

A UEPI RNG-REQ Pseudowire for a DOCSIS 3.1 OFDMA channel allows the RPD to send a burst received in IUCs 3 or 4 on that channel to the MAC using a UEPI RNG-REQ Pseudowire Transmission Unit. For OFDMA channels, the RPD MUST use the RNG-REQ pseudowire configured for that channel to send all bursts received in IUCs 3 or 4 on that channel. For OFDMA channels, the RPD MUST NOT send bursts received in IUCs 3 or 4 on the Data Pseudowire.

The format of UEPI RNG-REQ Pseudowire Transmission Unit for OFDMA channels is the same as that of the UEPI RNG-REQ Pseudowire Transmission Unit for SC-QAM channels; however, the formats of the header and trailer segments are different, as defined below. On UEPI RNG-REQ Pseudowires for OFDMA channels, the RPD MUST NOT spread a UEPI Transmission Unit across multiple PSP packets (PSP fragmentation). On UEPI RNG-REQ Pseudowires for OFDMA channels, the RPD MUST NOT combine multiple UEPI Transmission Units within a PSP packet (PSP concatenation).

8.2.4.1 UEPI RNG-REQ Header Segment

The UEPI Header Segment for RNG-REQ Pseudowire for an OFDMA channel has the format shown in Figure 13.

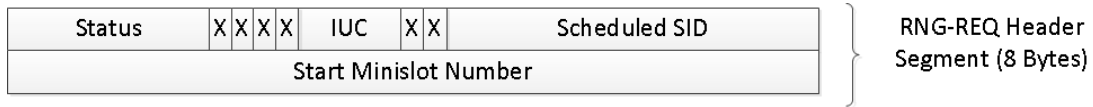

Figure 13 - UEPI RNG-REQ Header Segment Format

The fields of the UEPI Header Segment for OFDMA channel have the functions described in Table 9.

Table 9 - UEPI RNG-REQ Header Segment

Field	Size	Function
Status	8 bits	Bit 7:6 – Header Version Number 00 = Version 1 01, 10, 11: Reserved Bit 5 – RNG-REQ Type 0 = OFDMA Fine Ranging 1 = OFDMA Initial Ranging Bit 4 – Reserved Bit 3:2 – Reserved Bit 1 – HCS Flag (applicable to fine ranging) 0 = HCS check pass 1 = HCS check fail Bit 0 – CRC Flag (applicable to initial ranging and fine ranging) 0 = CRC check pass 1 = CRC check fail
X	1 bit	Reserved field.
IUC	4 bits	This is the IUC that the message was received in.
Scheduled SID	14 bits	The SID used in the MAP to grant bandwidth for the transmit opportunity associated with this UEPI Header Segment.
Start Minislot	32 bits	This is the minislot number that corresponds to the start of the transmit opportunity.

8.2.4.2 UEPI RNG-REQ Trailer Segment

The UEPI Trailer Segment for the UEPI RNG-REQ Pseudowire for OFDMA channel has the format shown in Figure 14.

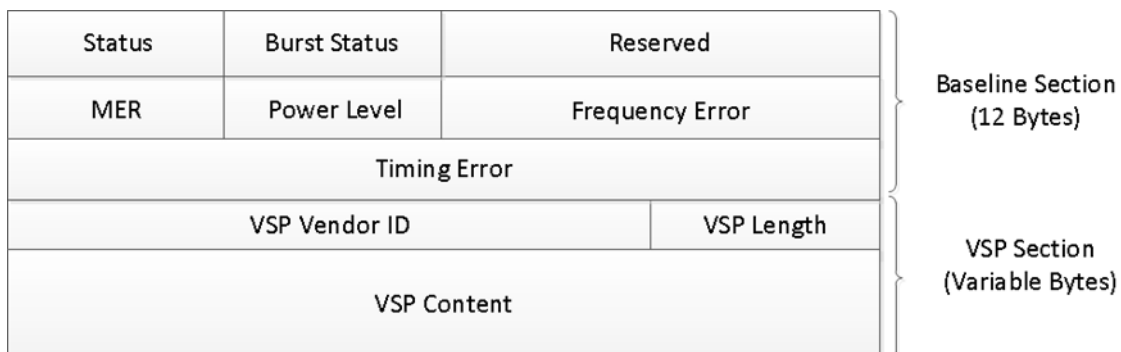

Figure 14 - UEPI RNG-REQ Trailer Segment Format

The fields of the UEPI Trailer Segment for an OFDMA channel are described in Table 10.

Table 10 - UEPI RNG-REQ Trailer Segment

Field	Size	Function
Status	8 bits	Bit 7:6 – Header Version Number 00 = Version 1 01, 10, 11: Reserved Bit 5 – MER field is valid 0 = MER field is not valid 1 = MER field is valid Bit 4 – Timing Error field is valid 0 = Timing Error field is not valid 1 = Timing Error field is valid Bit 3 – Frequency Error field is valid 0 = Frequency Error field is not valid 1 = Frequency Error field is valid Bit 2 –Burst Power Bin Level Field is valid 0 = Burst Power Bin Level Field is not valid 1 = Burst Power Bin Level Field is valid Bit 1 – Reserved Bit 0 – Vendor Specific Field present 0 = Vendor Specific Field is not present 1 = Vendor Specific Field is present
Burst Status	8 bits	Bit 7 -- Ranging/Probing Required 0 = Ranging/Probing is not required 1 = Ranging/Probing is required Bit 6:5 – FEC Status (Pre Syndrome error-free/Post Syndrome error free) 00 = Pass/pass 10 = Fail/pass 11 = Fail/fail Bits 4:3 -- Reserved Bits 2:0 -- Burst Power Bin Level (allowing 8 level comparison against 7 thresholds)* 000 = burst power below lowest threshold 001 - 110: burst power is in between lowest and highest thresholds 111 = burst power above highest threshold
Reserved	16 bits	
MER	8 bits	Measured average modulation error ratio, unsigned 8 bits in 0.25 dB units
Power Error	8 bits	Measured receive burst power relative to target burst power (defined as received power – target power**), signed 8 bits in 0.25 dB units
Frequency Error	16 bits	Measured receive frequency error (in Hz unit of measure), signed 16 bits.
Timing Error	32 bits	Measured receive timing relative to target upstream frame start time (defined as measured arrival time – target arrival time), signed 32 bits, 1/204.8 MHz units.
Vendor-specific field Vendor ID	3 bytes	IANA-assigned OUI for vendor. The bytes of this field are present only if the VendorField_Present bit is set.
Vendor-specific field length	1 byte	Indicates the length in bytes of the vendor-specific field. The bytes of this field are present only if the VendorField_Present bit is set. (See Table Note 1).
Vendor-specific field contents	N bytes	Vendor-specific field contents of length given in "Vendor-specific field length." The bytes of this field are present only if the VendorField_Present bit is set. (See Table Note 2).

Table Notes:

* The status bit behavior is intended to be Vendor-specific and detailed requirements for the behavior are outside the scope of this document.

** The expected power level for the channel is configured through RCP attributes BaseTargetRxPower (TLV 98.3) and TargetRxPowerAdjust (TLV 66.13).

1. The value of the Vendor-specific field length of the UEPI-RNG-REG Trailer Segment for an OFDM Channel field MUST NOT exceed 32.

2. The length of the Vendor-specific field contents of the UEPI-RNG-REQ Trailer Segment for an OFDM Channel field **MUST** be equal to the number of bytes indicated in the "Vendor-specific field length" field.

8.2.5 UEPI Request Pseudowire Format

The UEPI Request Pseudowire is used for aggregating request information from the DOCSIS upstream data path into a dedicated pseudowire. The UEPI Request Pseudowire uses the PSP Pseudowire format with a single PSP segment per PSP packet.

Each instance of a request in the DOCSIS upstream, either a standalone request or a piggyback request, is mapped into one request block. Standalone requests are extracted from the data stream and mapped into a request block. Piggyback requests are snooped such that they remain unaltered within the DOCSIS data frame, but the content of the piggyback request is mapped into a Request Block on the UEPI Request Pseudowire.

One or more Request Blocks are placed back-to-back into a single PSP segment. Since there is only one PSP segment per PSP packet, the PSP Segment table will have both the B bit and E bit asserted for that single segment.

8.2.5.1 UEPI Request Pseudowire Format for an OFDMA Channel

For OFDMA channels, there can be one or more request opportunities in a single minislot depending on the minislot size. The requests received in the same minislot need to be reported in the same PSP packet, such that these requests can be acknowledged using the same minislot number in a subsequent MAP message.

The UEPI Request Block contains the L2TP session ID of the UEPI Data Pseudowire associated with the upstream logical channel from which the request originated. The format of a single Request Block within this PSP segment is shown in Figure 15.

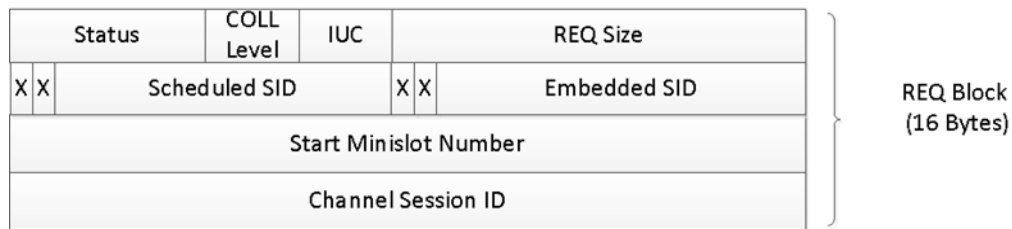

Figure 15 - UEPI REQ Block Format for an OFDMA Channel

The fields of the UEPI Request Block for an OFDMA channel are described in Table 11.

Table 11 - UEPI Request Block

Field	Size	Function
Status	8 bits	Bit 7:6 – Header Version Number 00 = Version 1 01, 10, 11: Reserved Bit 5:3 – SID Cluster from DOCSIS 3.0 segment header Bit 2 – SID Cluster valid 0 = SID Cluster is not valid 1 = SID Cluster is valid Bit 1 – REQ Units 0 = Request is in minislots. 1 = Request is in units of N bytes. Bit 0 – REQ Type 0 = Standalone request frame 1 = Piggyback request
COLL Level	4 bits	Bit 3 – Contention Request Collision Bin Level field is valid 0 = Contention Request Collision Bin Level field is valid 1 = Contention Request Collision Bin Level field is not valid Bits 2:0 – Contention request Collision Bin Level (allowing 8 level comparison with 7 thresholds) 000 = Collision level below lowest threshold 001 – 110: Collision level is in between lowest and highest thresholds 111 = Collision level above highest threshold
X	1 bit	Reserved field.
IUC	4 bits	This is the IUC that the message was received in.
REQ Size	16 bits	The number of minislots or number of bytes (in units of N bytes, where N is negotiated within the DOCSIS protocol) that the CM is requesting.
Scheduled SID	14 bits	The SID used in the MAP to grant bandwidth for the transmit opportunity in which the request was received.
Embedded SID	14 bits	The SID from the actual REQ frame, queue-depth based request frame or piggyback request in the DOCSIS Extended Header. Note: Set to zero when Embedded SID is absent (for CCF with DOCSIS 3.0 Segment Header ON).
Start Minislot	32 bits	This is the minislot number that corresponds to the start of the transmit opportunity.
LC Session	32 bits	The L2TP Session ID of the UEPI Data Pseudowire associated with the Logical Channel on which the request was received.

The RPD MUST snoop piggyback requests in Segment Header and extract all standalone requests and place them into a UEPI Request Pseudowire as described in this section. Due to the high capacity of the DOCSIS 3.1 OFDMA channel, this specification does not define a method for aggregation of requests from multiple OFDMA channels onto a shared request pseudowire. The CCAP Core MUST establish a separate request pseudowire for each OFDMA channel. The RPD MUST support establishment of a separate request pseudowire for each supported OFDMA channel.

The RPD is responsible for checking the DOCSIS HCS for all Requests (this includes standalone requests and requests carried in DOCSIS headers and Segment headers). If the HCS fails for a given Request, the RPD drops the Request.

To assist the scheduler with allocating the proper number of contention request opportunities, an optional Contention Request Collision Bin Level field is added to the UEPI request block. When valid, this field reports one of the 8 collision levels by comparing to the 7 thresholds provisioned to the RPD. The RPD may obtain the collision level with a sliding window to calculate the collision percentage over the last N contention REQ opportunities. N may be set to a power of 2 (up to 256) for easy implementation.

8.2.5.2 UEPI Request Pseudowire Format for an SC-QAM Channel

The UEPI Request Block contains the L2TP session ID of the UEPI Data Pseudowire associated with the upstream logical channel from which the request originated. The format of a single Request Block within this PSP segment for an SC-QAM channel is shown in Figure 16.

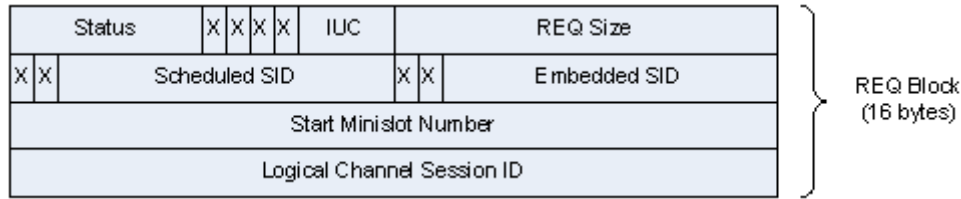

Figure 16 - UEPI REQ Block Format for an SC-QAM Channel

The fields of the UEPI Request Block for an SC-QAM channel are described in Table 12.

Table 12 - UEPI Request Block for an SC-QAM Channel

Field	Size	Function
Status	8 bits	Bit 7:6 – Header Version Number 00 = Version 1 01, 10, 11: Reserved Bit 5:3 – SID Cluster from DOCSIS 3.0 segment header Bit 2 – SID Cluster valid 0 = SID Cluster is not valid 1 = SID Cluster is valid Bit 1 – REQ Units 0 = Request is in minislots 1 = Request is in units of N bytes Bit 0 – REQ Type 0 = Standalone request frame 1 = Piggyback request
X	1 bit	Reserved field.
IUC	4 bits	This is the IUC that the message was received in.
REQ Size	16 bits	The number of minislots or number of bytes (in units of N bytes, where N is negotiated within the DOCSIS protocol) that the CM is requesting.
Scheduled SID	14 bits	The SID used in the MAP to grant bandwidth for the transmit opportunity in which the request was received.
Embedded SID	14 bits	The SID from the actual REQ frame, queue-depth based request frame or piggyback request in the DOCSIS Extended Header. Note: Set to zero when Embedded SID is absent (for CCF with DOCSIS 3.0 Segment Header ON).
Start Minislot	32 bits	This is the minislot number that corresponds to the start of the transmit opportunity.
LC Session	32 bits	The L2TP Session ID of the UEPI Data Pseudowire associated with the Logical Channel on which the request was received.

The RPD MUST ignore piggyback requests that appear in the DOCSIS header of DOCSIS MAC frames received as part of a fragmented concatenation (DOCSIS 1.1/2.0 fragmentation and concatenation). The RPD MUST snoop other piggyback requests and extract all standalone requests and place them into a UEPI Request Pseudowire as described in this section. The RPD MUST support aggregation of bandwidth requests from all SC-QAM US channels of an US RF Port onto a single BW Request pseudowire. The CCAP Core MUST establish a single bandwidth request pseudowire for all SC-QAM channels of RPD's US RF Port.

The RPD is responsible for checking the DOCSIS HCS for all Requests (these include standalone requests and requests carried in DOCSIS headers and Segment headers). If the HCS fails for a given Request, the RPD drops the Request.

The Scheduling Entity (CCAP Core) MUST accept requests from multiple logical and physical channels on one UEPI Request pseudowire.

8.2.6 UEPI MAP Pseudowire Format

The RPD uses DOCSIS MAP messages to determine when to expect upstream bursts and what parameters need to be used to receive those bursts. MAP messages are sent to the RPD on a separate UEPI MAP Pseudowire. One UEPI MAP Pseudowire exists for each channel (logical channel for SC-QAM channels) within the RPD.

The UEPI MAP Pseudowire uses the PSP Pseudowire format with a single PSP segment per PSP packet. Since there is only one PSP segment per PSP packet, the PSP Segment Table will have both the B bit and the E bit asserted for that single segment.

The content of the single PSP segment used in a UEPI MAP Pseudowire depends on the type of the channel served. Segment formats (copied from DOCSIS 3.1, see [MULPIv3.1]) are shown in Figure 17 for SC-QAM channels, Figure 18 for non-probe MAP frames for an OFDMA channel, and Figure 19 for probe frames. These are identical to DOCSIS MAP message formats, but without the DOCSIS header or CRC.

Note that since DOCSIS limits the length of a MAP message, the combination of a MAP message along with the PSP encapsulation will not exceed an Ethernet frame format of 2000 bytes for an OFDMA channel and 1500 bytes for an SC-QAM channel. For an OFDMA channel, with the UEPI encoding overhead, the maximum allowed number of non-Probe MAP IEs is reduced to 484, assuming UEPI over IPv4, instead of 490, as specified in DOCSIS 3.1 (see [MULPIv3.1]). There is no UEPI layer restriction to the number of Probe MAP IEs. For SC-QAM channels, the combination of a MAP message along with the PSP encapsulation **MUST NOT** exceed a legacy Ethernet MTU size of 1500 bytes.

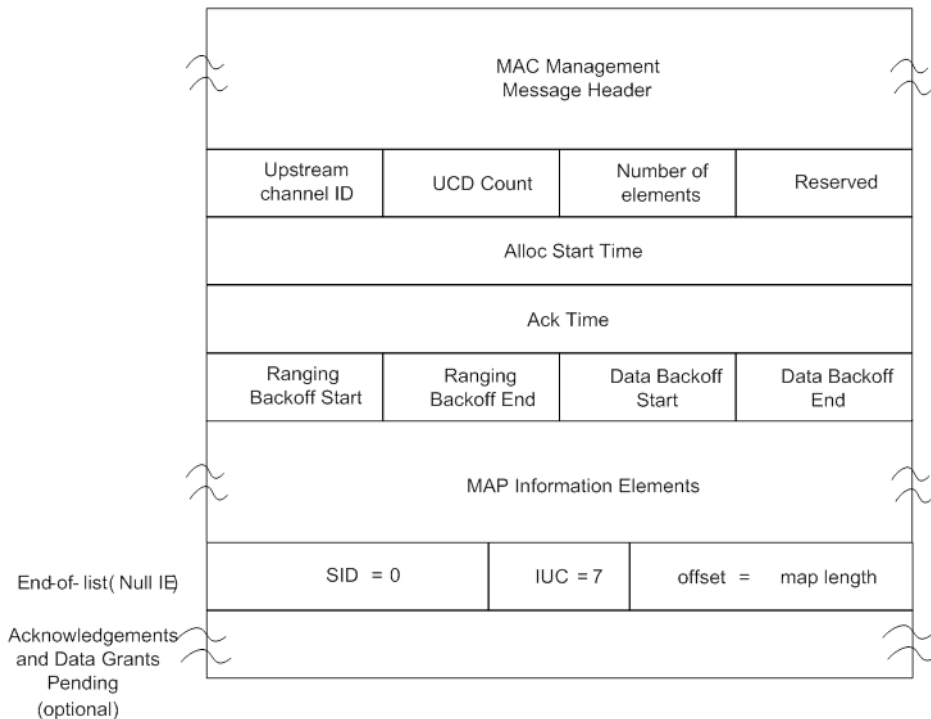

Figure 17 - Segment Format for the UEPI MAP Pseudowire for MAP Frames for an SC-QAM Channel

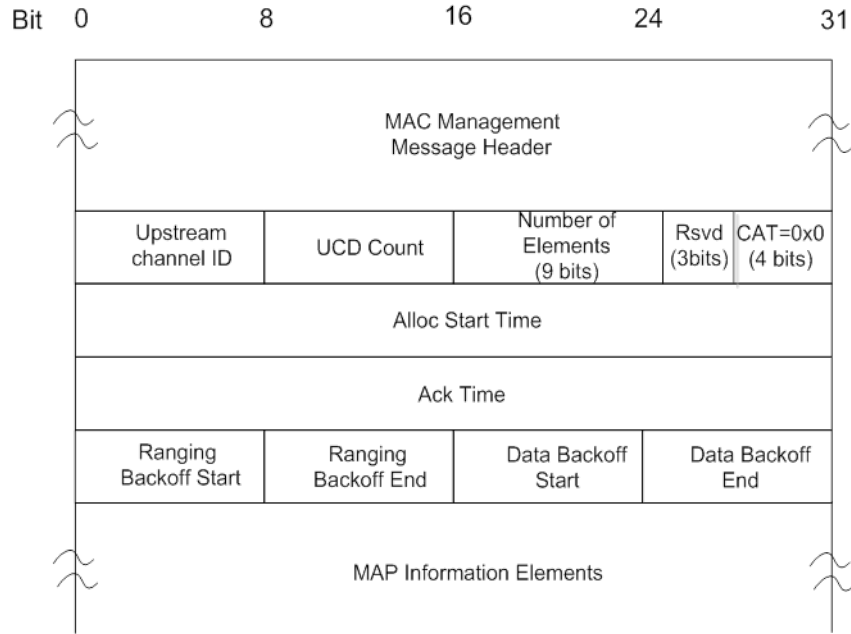

Figure 18 - Segment Format for the UEPI MAP Pseudowire (Version 5) Non-probe MAP Frames for an OFDMA Channel

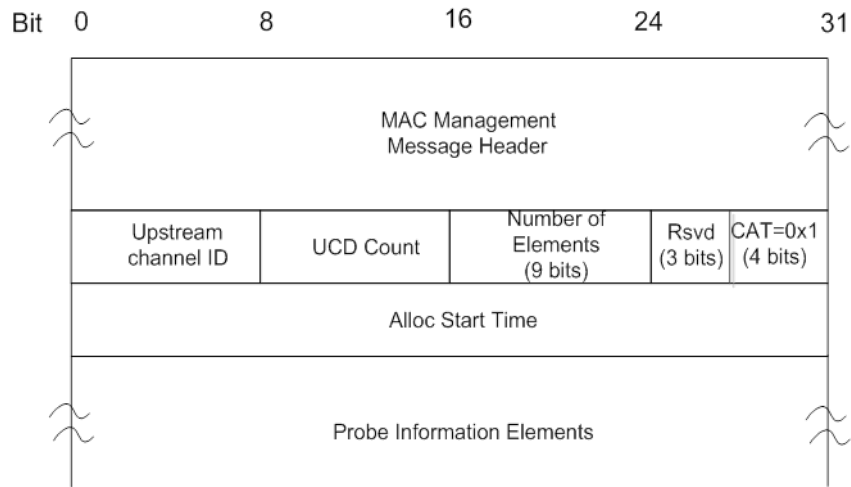

Figure 19 - Segment Format for the UEPI MAP Pseudowire for Version 5 Probe Frames

The Scheduling Entity (CCAP Core) MUST generate a UEPI MAP Pseudowire. The RPD MUST accept a UEPI MAP Pseudowire. The RPD MUST ignore all bytes after the null IE of a MAP message.

8.2.7 UEPI Probe Pseudowire Format

The UEPI Probe Pseudowire is used for reporting the PHY matrices measured at a cable modem's Probe Transmission opportunities allocated in a corresponding Probe MAP. A UEPI Probe Pseudowire Transmission Unit consists of a UEPI Header Segment, and one or more UEPI Payload Segments, as shown in Figure 20. There is one UEPI Probe Pseudowire defined for each OFDMA channel. On a UEPI Probe Pseudowire, the RPD MUST be able to spread the Payload Segments across multiple PSP packets (PSP fragmentation). However, the RPD MUST NOT combine multiple Probe Pseudowire Transmission Units within a PSP packet (PSP concatenation).

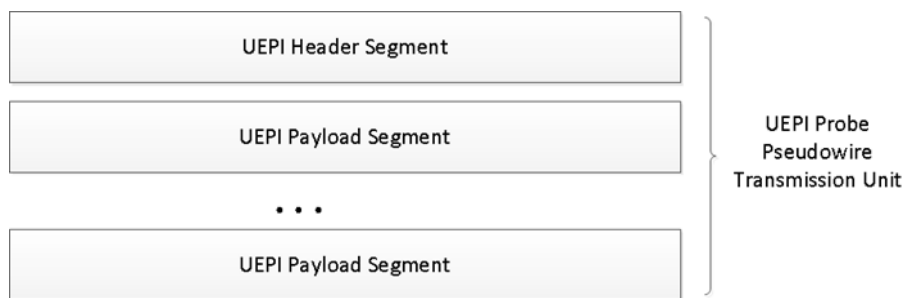

Figure 20 - UEPI Probe Pseudowire Transmission Unit

8.2.7.1 UEPI Probe Header Segment

The UEPI Header Segment for Probe Pseudowire has the format shown in Figure 21.

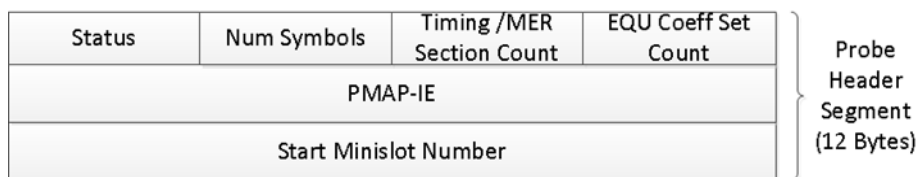

Figure 21 - UEPI Probe Pseudowire Header Segment

The fields of the UEPI Header Segment have the functions defined in Table 13.

Table 13 - UEPI Probe Header Segment

Field	Size	Function
Status	8 bits	Bit 7:6 – Header Version Number 00 = Version 1 01, 10, 11: Reserved Bit 5 – Reserved Bit 4 – Average MER field is valid Bit 3:2 – Multi-section Timing/MER reporting content 00 = No multi-section Timing/MER report present 01 = Multi-section Timing Error report is present 10 = Multi-section MER report is present 11 = Multi-section Timing Error and MER reports both present Bit 1 – Frequency Error field is valid 0 = Frequency Error field is not valid 1 = Frequency Error field is valid Bit 0 – Vendor Specific field present 0 = Vendor Specific field is not present 1 = Vendor Specific field is present
Num Symbols	8 bits	Number of symbols in probe
Timing/MER Section Count	8 bits	Number of sections of the average Timing Errors, M
EQU Coeff Set Count	8 bits	Number of Equalizer Coefficient Sets, N
PMAP-IE	32 bits	First PMAP-IE used for this probe.
Start Minislot	32 bits	This is the minislot number that corresponds to the first minislot of the first probe frame.

8.2.7.2 UEPI Probe Payload Format

The UEPI Payload Segment for the Probe Pseudowire has the format shown in Figure 22.

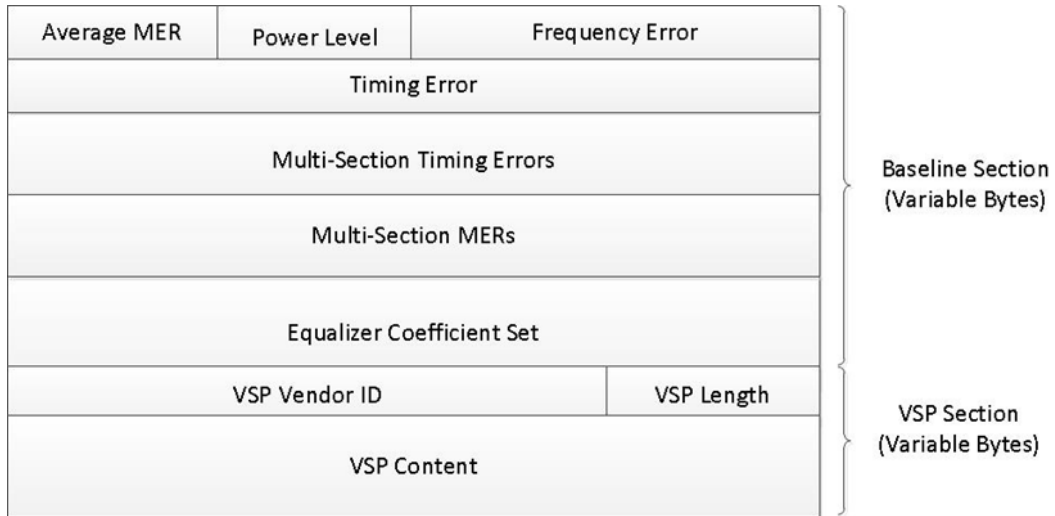

Figure 22 - UEPI Probe Payload Format

The fields of the UEPI Payload Segment have the functions defined in Table 14.

Table 14 - UEPI Probe Payload Format

Field	Size	Function
Average MER	8 bits	Received MER averaged across all subcarrier MER sections
Power Error	8	Measured receive burst power relative to target burst power (defined as received power – target power*), signed 8 bits in 0.25 dB unit.
Frequency Error	16	Measured receive frequency error, in Hz unit of measure, signed 16 bits.
Timing Error	32	Timing Error that matches equalizer coefficients to be loaded in RNG-RSP, signed 32 bits, 1 /204.8 MHz units.
Multi-Section Timing Errors	32 * M	Multi-section average timing errors. Each timing error is reported in signed 32 bits, 1 /204.8 MHz units.
Multi-Section MERs	32 * ceiling(M/4)	Multi-section average MERs. Each MER is reported in unsigned 8 bits, 0.25 dB units. This field contains M reported MER values, followed by sufficient zero-padding to align the total field size to a 32-bit boundary.
Equalizer Coefficient Sets	{ 32 * (2+Hsc – Lsc) bits } each set for N sets	TX equalization data to be loaded in RNG-RSP. Multiple sets can be used if there are a large number of excluded subcarriers in between active subcarrier regions. Each set includes: { Lowest subcarrier number for which coefficient is being loaded, Lsc (16 bits: 0-11 subcarrier index, 12-15: reserved) Highest subcarrier number for which coefficient is being loaded, Hsc (16 bits: 0-11 subcarrier index, 12-15: reserved) List of coefficients in order from lowest to highest subcarrier with 2 byte (16-bit signed value) real coefficients followed by 2 byte (16-bit signed value) imaginary coefficients. }
Vendor-specific Vendor ID	3 bytes	IANA-assigned OUI for vendor. The bytes of this field are present only if the VendorField_Present bit is set.
Vendor-specific field length	1 byte	Indicates the length in bytes of the vendor-specific field. The bytes of this field are present only if the VendorField_Present bit is set. (See Table Note 1)
Vendor-specific field contents	N bytes	Vendor-specific field contents of length given in "Vendor-specific field length." The bytes of this field are present only if the VendorField_Present bit is set. (See Table Note 2)

Table Notes:

* The expected power level for the channel is configured through RCP attributes BaseTargetRxPower (TLV 98.3) and TargetRxPowerAdjust (TLV 66.13).

1. The value of the Vendor-specific field length of the UEPI Payload Segment field MUST NOT exceed 32.
2. The length of the Vendor-specific field length of the UEPI Payload Segment field MUST be equal to the number of bytes indicated in the "Vendor-specific field length" field.

For the Equalizer Coefficient reporting:

- The RPD MUST support reporting of at least one set of Equalizer Coefficients for all subcarriers.
- The RPD MUST report each set of Equalizer Coefficients in the following order: lowest subcarrier number, highest subcarrier number and the list of coefficients in order from lowest to highest subcarrier with 2 byte (16-bit signed value) real coefficients followed by 2 byte (16-bit signed value) imaginary coefficients. The precise format of the coefficients is defined in [PHYv3.1] section "Upstream Pre-Equalization".
- The RPD MAY choose to report zero-value for any corresponding excluded subcarrier.
- The RPD MAY choose to skip the excluded subcarriers by reporting the Equalizer Coefficients in multiple sets.
- The RPD MAY choose to use a threshold to suppress insignificant updates; however, if any coefficients are provided, all will be provided, except the excluded subcarriers, to avoid phase discontinuity.

For the Timing Error reporting:

- The RPD MUST provide a single Timing Error that is used to match the equalizer coefficient calculation. This Timing Error value will be sent back to the CM in RNG-RSP.
- The RPD MAY choose to group the subcarriers into multiple non-overlapping sections, and report one averaged Timing Error for each section.

For the MER reporting:

- The RPD MUST support reporting of a single averaged MER.
- The RPD MAY choose to group the subcarriers into multiple non-overlapping sections, and report one averaged MER for each section.

The number of sections and the subcarrier to section mapping for average Timing Error and MER reporting are set up through GCP.

8.2.8 UEPI Spectrum Management Pseudowire Format

The UEPI Spectrum Management (SpecMan) Pseudowire uses the PSP Pseudowire format. The UEPI SpecMan Pseudowire Transmission Unit MAY span one or more PSP segments, and MAY span one or more PSP packets. There MAY be more than one UEPI SpecMan Pseudowire per RPD.

The contents of the UEPI SpecMan Pseudowire Transmission Unit is vendor-specific. The formats of these contents are negotiated in the UEPI Control Plane.

Spectrum Management Pseudowires MAY use PSP fragmentation. Spectrum Management Pseudowires MUST NOT use PSP concatenation.

8.2.9 UEPI PNM Transmission Unit Format

UEPI PNM Transmission Units are used to report channel-specific and spectrum-wide PNM information from the RPHY to the CCAP Core.

UEPI PNM Transmission Units are carried on one or more UEPI PNM Pseudowires. The number of UEPI PNM Pseudowires and the assignment of functions to pseudowires is vendor-specific and is negotiated in the control plane.

For channel-specific data, the two types of PNM data are: 1) Upstream Capture for Active and Quiet Probes data, and 2) upstream RxMER data (see [PHYv3.1]).

For spectrum-wide data, the two types of PNM data are: 1) impulse noise statistics, and 2) wideband spectrum analysis. Narrowband spectrum analysis data can be communicated by the UEPI SpecMan Pseudowire.

An upstream capture of an OFDMA channel can be performed during an upstream probe transmission or during a quiet time when the capture can view the underlying noise floor.

The RxMER data can be measured during a probe corresponding to a P-MAP IE with the MER bit set to 1.

PNM upstream histogram data is communicated via the control plane.

When transmitting different PNM types on a single Pseudowire, the RPD MUST encode the Status byte as the first byte of the PNM Transmission Unit header according to Table 15 - Status Byte Encoding in PNM Transmission Unit Header.

Table 15 lists the specific PNM types and the encoded values in the Status byte.

When transmitting different PNM types by using one PNM Pseudowire per PNM type, the RPD MAY encode the Status byte as the first byte of the PNM Transmission Unit header according to Table 15 - Status Byte Encoding in PNM Transmission Unit Header.

Table 15 - Status Byte Encoding in PNM Transmission Unit Header

Field	Size	Function
Status	8 bits	Bit 7:6 – Header Version number 00 = Version 1 01, 10, 11: Reserved Bit 5:2 – PNM Type 0000 = Upstream Capture for Active and Quiet Probes 0001 = Triggered Wideband Spectrum Analysis 0010 = RxMER 0011 = Impulse Noise Statistics 0100 – 1111 = Reserved Bit 1:0 – Reserved

The Status byte is followed by a specific format or vendor-specific content, depending on the PNM Type, as specified in the subsections that follow.

8.2.9.1 Upstream Capture for Active and Quiet Probes

Figure 23 shows the Upstream Capture for Active and Quiet Probes Transmission Unit with header and payload. There is no trailer for this pseudowire transmission unit.

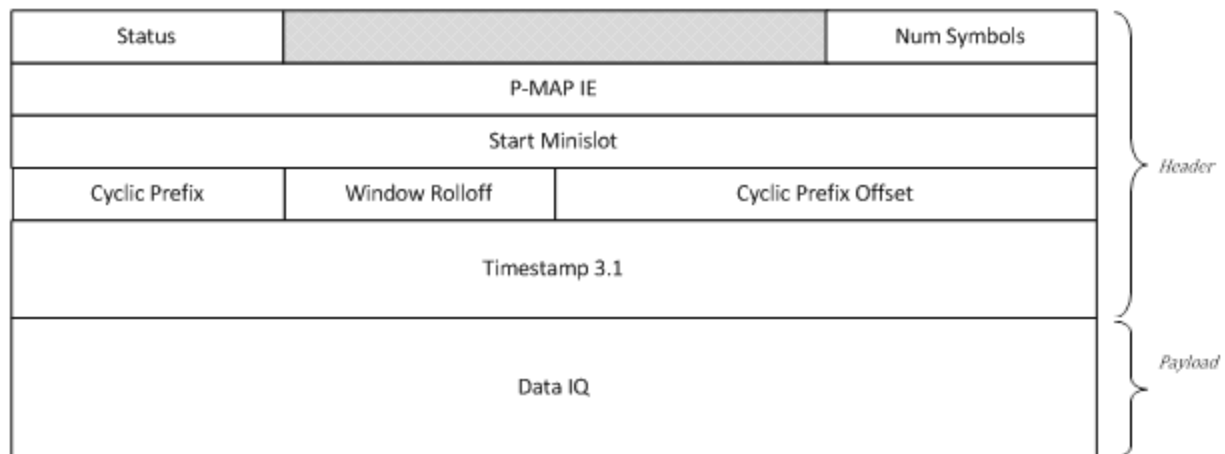

Figure 23 - Upstream Capture for Active and Quiet Probes Transmission Unit

8.2.9.2 Upstream Capture for Active and Quiet Probes Header

Table 16 shows the UEPI Channel Pseudowire Header Segment format for Upstream Capture for Active and Quiet Probes.

Table 16 - UEPI Header Segment for Upstream Capture for Active and Quiet Probes

Field	Size	Function
Status	8 bits	Bit 7:6 - Header Version number 00 = Version 1 01, 10, 11: Reserved Bit 5:2 – 0000 Bit 1:0 – Reserved Or Bit 5:0 – Reserved (option for PNM Pseudowire containing only one PNM Type)
Reserved	16	
Number of Symbols	8	The number of capture symbols in this probe
PMAP-IE	32	The first PMAP-IE used for this probe
Start Minislot	32	The minislot number that corresponds to the first minislot of the first probe frame.
Cyclic Prefix	8	The cyclic prefix size used for receiving this probe: 1: 96 samples 2: 128 samples 3: 160 samples 4: 192 samples 5: 224 samples 6: 256 samples 7: 288 samples 8: 320 samples 9: 384 samples 10: 512 samples 11: 640 samples
Window Rolloff	8	The rolloff window size used for receiving this probe, in 1 /102.4 MHz units.
Cyclic Prefix Offset	16	The index number of the first sample used for FFT starting from the beginning of the cyclic prefix. E.g., index 0 refers to the first sample of the cyclic prefix.
Timestamp	64	DOCSIS 3.1 timestamp of this capture probe.

8.2.9.3 Upstream Capture for Active and Quiet Probes Payload

Table 17 shows the contents of the UEPI Upstream Capture for Active and Quiet Probes Payload Segment with samples in time domain format.

Table 17 - UEPI Upstream Capture for Active and Quiet Probes Payload Segment

Field	Size	Function
Data	Number of symbols*(2048 or 4096 + number of samples in cyclic prefix)*32	The data I/Q samples before the FFT, at a sample rate of 102.4 Mbps.

The RPD MAY support Upstream Capture for Active and Quiet Probes with samples represented in frequency domain format. The UEPI Payload Segment format for samples in frequency domain is left to vendor definition.

8.2.9.4 RxMER Format

The RxMER Pseudowire Transmission Unit format with header, payload, and trailer is shown in Figure 24.

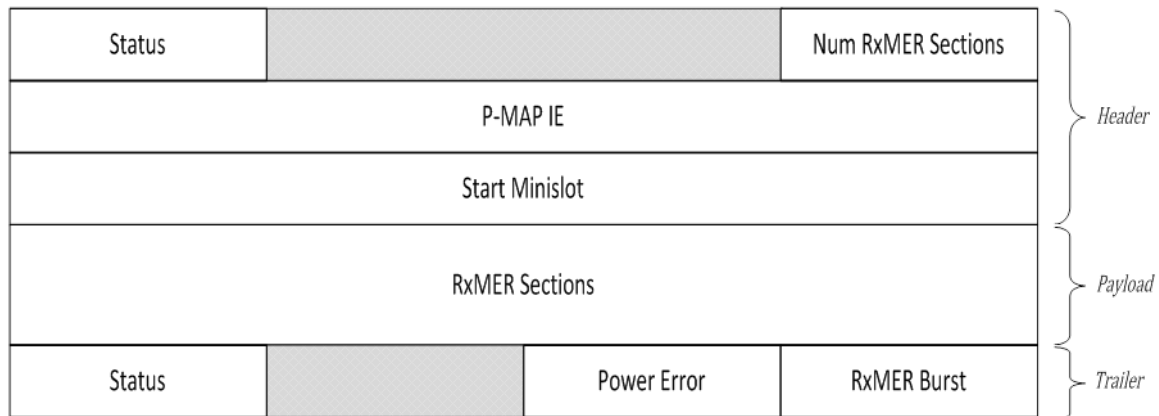

Figure 24 - RxMER Pseudowire Transmission Unit Format

8.2.9.5 RxMER Header Segment

Table 18 shows the details of the RxMER Pseudowire Transmission Unit Header Segment.

Table 18 - UEPI RxMER Header Segment

Status	8	Bit 7:6 - Header Version number 00 = Version 1 01, 10, 11: Reserved Bit 5:2 – 0010 Bit 1:0 – Reserved Or Bit 5:0 – Reserved (option for PNM Pseudowire containing only one PNM Type)
Reserved	16	
Number RxMER Sections	8	The number of RxMER sections included in the payload.
PMAP-IE	32	The first PMAP-IE used for this probe.
Start Minislot	32	This is the minislot number that corresponds to the first minislot of the first probe frame.

8.2.9.6 RxMER Payload Segment

Table 19 shows the details of the RxMER Pseudowire Transmission Unit Payload Segment.

Table 19 - UEPI RxMER Payload Segment

Field	Size	Function
Per RxMER Section		
Reserved	4	
Lowest Subcarrier	12	Lowest subcarrier number of the RxMER section.
Reserved	4	
Highest Subcarrier	12	Highest subcarrier number of the RxMER section.
MER per Subcarrier	Variable: 0 to 3800*8	Measured average RxMER per subcarrier, unsigned 8 bit, 0.25 dB units.
Padding	24 or 16 or 8 or 0	Zero pad to force 32-bit alignment when the MER per Subcarrier field is not 32-bit aligned.

8.2.9.7 RxMER Trailer Segment

Table 20 shows the details of the RxMER Pseudowire Transmission Unit Trailer Segment.

Table 20 - UEPI RxMER per Subcarrier Trailer Segment

Field	Size	Function
Status	8	Bit 7:6 - Trailer Version number 00 = Version 1 01, 10, 11: Reserved Bit 5:20 – 0010 Bit 1:0 – Reserved Or Bit 5:0 – Reserved (option for PNM Pseudowire containing only one PNM Type)
Reserved	8	
Power Error	8	Measure receive burst power relative to target burst power (defined as received power – target power*), signed 8-bit, 0.25 dB units.
RxMER Burst	8	Measured average modulation error ratio over all subcarriers in units of 0.25 dB.

Table Notes:

- * The expected power level for the channel is configured through RCP attributes BaseTargetRxPower (TLV 98.3) and TargetRxPowerAdjust (TLV 66.13).

8.2.9.8 UEPI Impulse Noise Statistics

The UEPI Impulse Noise Statistics Transmission Units are sent on a pseudowire that uses the PSP Pseudowire format. The UEPI Impulse Noise Statistics Pseudowire Transmission Unit MAY span one or more PSP segments. The UEPI Impulse Noise Statistics Pseudowire Transmission Unit MAY span one or more PSP packets.

The contents of the UEPI Impulse Noise Statistics Transmission Units are vendor-specific. The format of these contents is negotiated in the UEPI Control Plane.

Impulse Noise Statistics Transmission Units MAY use PSP fragmentation. Impulse Noise Statistics Transmission Units MUST NOT use PSP concatenation.

8.2.9.9 UEPI Triggered Wideband Spectrum Analysis

The UEPI Triggered Spectrum Analysis Transmission Units are sent on a pseudowire that uses the PSP Pseudowire format. The UEPI Triggered Spectrum Analysis Pseudowire Transmission Unit MAY span one or more PSP segments. The UEPI Triggered Spectrum Analysis Pseudowire Transmission Unit MAY span one or more PSP packets.

The contents of the UEPI Triggered Spectrum Analysis Transmission Units are vendor-specific. The formats of these contents are negotiated in the UEPI Control Plane.

Triggered Spectrum Analysis Transmission Units MAY use PSP fragmentation. Triggered Spectrum Analysis Transmission Units MUST NOT use PSP concatenation.

8.2.9.10 UEPI Narrowband Spectrum Analysis

Narrowband spectrum analysis data can be communicated by the UEPI SpecMan Pseudowire as discussed in Section 8.2.8.

8.2.10 UEPI EC-REQ Pseudowire

The EC-REQ PW is a UEPI pseudowire which carries requests from the RPD to the CCAP Core to adjust the EC Training scheduling. Only RPDs which support FDX and Scheduled EC Training method are required to support UEPI EC-REQ pseudowire. Normative requirements for support of UEPI EC-REQ Pseudowire and the details of the protocol interaction for this pseudowire are defined in [R-PHY].

A CCAP Core creates a single EC-REQ UEPI PW per RPD US RF Port.

The EC-REQ PW uses PSP format. The EC-REQ PW carries messages in the form of one PSP segment that can include one or more EC-REQ blocks. Multiple EC-REQ blocks can be included in a single PSP segment if the RPD determines that EC training adjustment is needed on multiple channels simultaneously. An EC-REQ block contains the EC request information associated with an FDX OFDMA channel, including:

- The identifier (Index) of an OFDMA channel.
- The requested ECT period.
- The requested ECTO duration.

8.2.10.1 UEPI EC-REQ Pseudowire Transmission Unit Format

8.2.10.1.1 EC-REQ UEPI Block Format

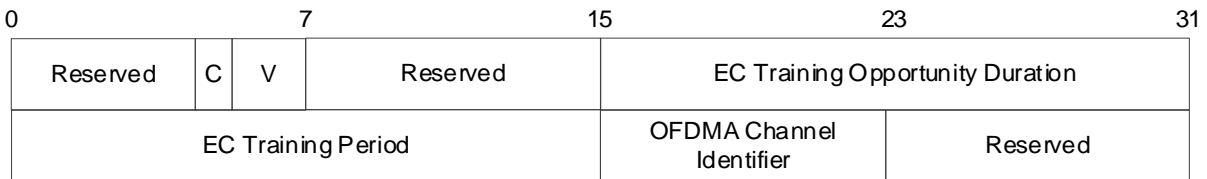

Figure 25 - UEPI EC-REQ Block Format

Status: An 8-bit field

- Bits 7:6 – V: Header Version Number (00 = Version 1; 01, 10 and 11 are reserved)
- Bit 5 – C: EC Convergence Status,
 - 0 – EC is not converged.
 - 1 – EC is converged.
- Bits 4:0 – Reserved

EC Training Opportunity Duration: a 16-bit field that specifies the requested ECTO duration via the number of OFDMA symbols. The value sent by the RPD does not have match the integral number of OFDMA frames.

EC Training Period: a 16-bit field that specifies the requested ECT period in milliseconds. When the RPD sends EC-REQ with this attribute set to zero, it constitutes a request for the CCAP Core to issue the opportunity exactly one time.

OFDMA Channel Identifier: An 8-bit index of the OFDMA channel in the RPD US RF Port.

The RPD MUST limit the number of EC-REQ blocks in a single PSP segment to the number of enabled OFDMA FDX channels per US RF Port. The FDX frequency plan defined in [PHYv3.1] imposes a limit on the number of FDX OFDMA channels per US RF port to six.

9 UEPI OPERATION

9.1 No Burst Events

A No Burst event occurs when an upstream burst transmission has been scheduled to occur, but a DOCSIS preamble is not detected. Examples of situations which would result in a No Burst event include scheduled request slots in which either no message is received, or a collision occurs between requests sent simultaneously by multiple CMs.

The RPD MUST follow the expected behavior described in Table 21 - No Burst Event Responses when a No Burst event occurs. The bit values listed in the table header refer to the high and low energy bits as defined in Table 6 - UEPI Trailer Segment for an SC-QAM Channel and Table 8 - UEPI Trailer Segment for an OFDMA Channel. Each separate entry in Table 21 - No Burst Event Responses, both for the IUC-SID value and for the energy value, corresponds to a separate counter.

Note that a No Burst event does not contain any valid data. Thus, any content received from the RF interface is discarded. As noted in the table, when a No Burst event occurs, the RPD will take one of the following actions corresponding to the cause of the No Burst event:

- Do nothing. These are either causes of No Burst events that do not demand that action be taken, or causes that are undefined at this time.
- Count the events per logical channel and make the count values available through the upstream channel performance TLVs defined in [R-PHY].
- Send a No Burst Transmission Unit as defined for the corresponding Pseudowire type.

The RPD recognizes two categories of SIDs for request IUCs: multicast and unicast. SID values in the range 0x3E00 to 0x3FFF are counted in the multicast category. This range includes the broadcast SID, the well-known multicast SIDs, and the priority request SIDs as defined by [MULPIv3.1]. All other SID values are counted in the unicast category.

Table 21 - No Burst Event Responses

IUC – SID Usage	Low Energy (01) "Dead Air"	Medium Energy (00) "Garbled Data"	High Energy (10) "Collision"
1 – Broadcast/Multicast Request	B	B	B
1 – Unicast Request	B	B	B
2 – Broadcast Request_2	B	B	B
3 – Initial Maintenance Broadcast	B	B	B
3 – Initial Maintenance Unicast	B	B	B
4 – Station Maintenance	B	B	B
5 – Data Profile (Short Data Grant)	C	B	B
6 – Data Profile (Long Data Grant)	C	B	B
7 – Null IE	A	A	A
8 – Reserved (Data Acknowledgement)	A	A	A
9 – Data Profile (Adv PHY Short Data Grant)	C	B	B
10 – Data Profile (Adv PHY Long Data Grant)	C	B	B
11 – Data Profile (Adv PHY UGS)	C	B	B
12-13 when applied to SC-QAM – Reserved	A	A	A
12-13 when applied to OFDMA – Data Profile	C	B	B
14 – Reserved	A	A	A
15 – Expansion	A	A	A
Where: A – Do nothing. These are either non-events or undefined events at this time. B – Count the events per logical channel and make the count values available through the upstream channel performance TLVs defined in [R-PHY]. C – Send a No Burst Transmission Unit as defined for the corresponding Pseudowire type.			

9.2 Quality of Service

When a DOCSIS burst is received from the RF interface, the RPD associates the incoming DOCSIS burst with a Scheduled SID. The RPD uses the Scheduled SID and the Logical Channel ID to index a table to determine what QoS information is to be used for the appropriate headers of the UEPI packet. The UEPI control plane is responsible for populating the QoS table.

The RPD MUST provide at least four levels of QoS for each UEPI Data Pseudowire (R-DEPI pseudowires of type PSP-UEPI-SCQAM or PSP-UEPI-OFDM). For the other UEPI Pseudowires (RNG-REQ, Request, MAP, and SpecMan), the RPD MUST provide one level of QoS for each Pseudowire.

The RPD MUST maintain a separate PSP Flow ID for each level of QoS. The RPD MUST maintain a separate PSP Sequence number space for each level of QoS.

The RPD MUST statically map those levels of QoS to all appropriate UEPI QoS headers, including [IEEE 802.1q], IPv4 (see [RFC 791]), and IPv6 (see [RFC 2460]). The RPD MUST be able to map those levels to any valid value within the operating range of each the appropriate QoS headers.

The RPD is not required to support implicit mapping (via deep packet inspection) of any of the fields in the IP packet contained within the upstream DOCSIS burst into any of the fields of the UEPI header.

9.3 Sequencing and Flow IDs

UEPI uses packet sequencing to permit the detection of lost packets. This is necessary to prevent reassembly errors when receiving PSP fragmentation. Even when multiple levels of QoS exist within a session, packet re-ordering between levels of QoS can occur within the network. Thus, any use of sequence numbers MUST be constrained to a particular QoS level.

UEPI transmitting entities MUST enable sequencing on all UEPI Pseudowires. UEPI transmitting entities MUST maintain a separate PSP Flow ID for each level of QoS. UEPI transmitting entities MUST maintain a separate PSP Sequence number space for each Flow ID.

UEPI receiving entities SHOULD use the sequence number to detect and report dropped or misordered packets. UEPI receiving entities are not required to re-order packet flows.

9.4 Bandwidth Request Aggregation

The aggregation of individual bandwidth requests into UEPI packets sent on a UEPI pseudowire involves a tradeoff between optimizing operation for maximum efficiency and for minimal latency. In a possible worst-case scenario, if the RPD processed every received bandwidth request and immediately sent it in a UEPI packet with just one Request Block, this could result in a very high rate of small UEPI packets on the Request Pseudowire. Such packets would also be subject to a significant encapsulation overhead because the UEPI packet header (layers 2-4) is much longer than the length of a single Request Block. In the interest of reducing packet rates and lowering encapsulation overhead on UEPI Request Pseudowires, the RPD needs to aggregate multiple Request Blocks into a single UEPI packet. When the RPD supports aggregation, that implies that the RPD needs to delay Requests and maintain a queue of Request Blocks. The CCAP Core governs the Request Block queuing process to achieve optimal performance and to avoid excessive delays in the delivery of bandwidth requests.

The GCP control plane provides the CCAP Core with two standard attributes to control the bandwidth request aggregation process in the RPD:

- The CCAP Core can configure the Maximum Request Block Enqueue Timeout (MaxReqBlockEnqTimeout) attribute. This attribute is defined as the maximum time a request can be held in the queue. The RPD MUST flush the queue and send the requests in a packet on the UEPI Request pseudowire when the oldest request in the queue has been held for Maximum Request Block Enqueue Timeout period. The range of valid values for Maximum Request Block Enqueue Timeout is 0-500 microseconds. The default value of this attribute is 0 microseconds. When the value of Maximum Request Block Enqueue Timeout is set to zero, the RPD MUST immediately send an UEPI packet after reception of a bandwidth request. Note that this requirement does not mandate that, when the value of Maximum

Request Block Enqueue Timeout is set to zero, then RPD is required to send exactly one bandwidth request per UEPI packet.

- The CCAP Core can configure the Maximum Number of Enqueued Request Blocks (MaxReqBlockEnqNumber) attribute which is defined as the maximum number of enqueued Request Blocks for a UEPI request pseudowire. When the Request Block queue in the RPD reaches the depth defined by this attribute, the RPD MUST flush the Request Block queue and send the requests in a single UEPI packet to the CCAP Core. The range of valid values for this attribute is 1 to 63. The default value is 1. If the Maximum Number of Enqueued Request Blocks attribute is set to 1, the RPD MUST immediately send a UEPI packet after reception of a bandwidth request. The CCAP Core MUST set the value of Maximum Number of Enqueued Request Blocks attribute to be sufficiently small so that all enqueued requests fit into a single UEPI packet.

The RPD MUST enforce both Bandwidth Request queuing criteria Maximum Request Block Delay Timeout and Maximum Number of Enqueued Request Blocks simultaneously. The RPD MUST process the Request Block queue and send UEPI packet if either criterion is met.

Both attributes can be configured per request pseudowire. Consequently, the GCP/RCP messaging supports the following cardinality:

- Since just one request pseudowire is created for all upstream SC-QAM channels of an RPD's RF port, Bandwidth Request queuing attributes for SC-QAM channels are configured per RP port.
- Since a separate request pseudowire needs be created for each OFDMA channel, Bandwidth Request queuing attributes for OFDMA channels are configured per OFDMA channel.

This specification permits implementations where the RPD enforces these attributes with granularity greater than one microsecond or one Request Block, as applicable. If the RPD implements enforcement of the attributes with a granularity greater than one unit, the RPD MUST use the nearest supported value that is lower than the value which has been written by the CCAP Core. The RPD MUST report the actual enforced values when these attributes are read by the CCAP Core.

Appendix I R-UEPI and DMPI (Informative)

The values of the fields and the location of the fields in either the R-UEPI Header Segment or Trailer are closely related to the DOCSIS MAC PHY Interface (DMPI) specification (see Annex F of [MULPIv3.0]). DMPI defines the interface between the CMTS Upstream PHY and the MAC chip. In doing so, DMPI reflects the real-time operation of the PHY. DMPI's transport information is stored in the information blocks shown in Table 22.

Table 22 - R-UEPI's DMPI-defined Transport Path

DMPI Block	Function
FIRST_DATA	Beginning of a DOCSIS burst plus select status.
MIDDLE_DATA	Middle of a DOCSIS burst.
LAST_DATA	End of a DOCSIS burst plus select status.
PHY_STATUS	Vendor-specific PHY characteristics sent after LAST_DATA.
NO_BURST	Indicates that no recoverable burst was received during a transmit opportunity. An example is a contention interval with multiple contenders.
CHANNEL	Used to indicate the logical channel. This block is sent prior to FIRST_BLOCK.

The functions contained in the R-UEPI Header Segment are derived from the status in the FIRST_BLOCK and NO_BURST. The functions contained in the UEPI Trailer Segment are derived from the DMPI LAST_BLOCK and PHY_STATUS blocks (see [MULPIv3.0]). The CHANNEL information is associated with the Session ID.

The R-UEPI Header Segment and Trailers also contain additional functionality beyond DMPI that is necessary for M-CMTS operation.

NOTE: The DOCSIS MAC PHY Interface (DMPI) is not applicable to DOCSIS 3.1 technology. It is, however, applicable to DOCSIS 3.0 technology.

Appendix II Acknowledgements

On behalf of the cable industry and our member companies, CableLabs would like to thank the following individuals for their contributions to the development of this specification:

Contributor	Company Affiliation
Niki Pantelias	Broadcom
John T. Chapman, De Fu Li, Tong Liu, Pawel Sowinski	Cisco

On behalf of the cable industry and our member companies, CableLabs would like to thank the following individuals for their contributions to the development of the technology and participation in the Remote PHY Working Group.

Contributor	Company Affiliation
Bill Powell	Alcatel-Lucent
Brian Kurtz	Altera
Carlton Lane, Linda Mazaheri	Analog
Tom Ferreira, Steve Foley, Anand Goenka, Jeff Howe, Hari Nair	Arris
Andrew Chagnon, Victor Hou, Niki Pantelias, David Pullen	Broadcom
Stuart Hoggan, Volker Leisse, Jon Schnoor, Karthik Sundareshan, Nikhil Tayal, Jun Tian	CableLabs
Andrew Sundelin	CableLabs Consultant
Naor Goldman	Capacicom
Dave Fox, Maik Geng	Casa Systems
David Claussen	Charter
Nobo Akiya, Alon Bernstein, Brian Bresnahan, John T. Chapman, Hang Jin, Tong Liu, Carlos Pignataro, Sangeeta Ramakrishnan, John Ritchie, Pawel Sowinski, Don Strausberger, Yi Tang, Bill Wall, Gerry White	Cisco
Philippe Perron	Cogeco
John Bevilacqua, Nagesh Nandiraju, Saifur Rahman, Jorge Salinger, Joe Solomon, Douglas Will	Comcast
Jeff Ford, Al Garrett	Complex IQ
Ony Anglade, Mike Cooper	Cox Communications
Samir Parikh	Gainspeed Networks
João Campos, Even Kristoffersen	Get
Adi Bonen, Mike Patrick	Harmonic
Jim Chen, Hesham ElBakoury, Karl Moerder, Jack Moran, Guangsheng Wu	Huawei
Phil Oakley	LGI
Stan Bochenek, Ajay Kuckreja	Maxim Integrated
Len Dauphinee, David Huang, Louis Park, Sridhar Ramesh, Patrick Tierney, Scott Walley	MaxLinear
Rei Brockett	Pace/Aurora
Nasir Ansari, George Hart	Rogers
Kevin Kwasny	Shaw
Lee Johnson	ST Micro
Paul Brooks, Kirk Erichsen	Time Warner Cable
Colin Howlett, Douglas Johnson	Vecima
Faten Hijazi, Alex Luccisano	Xilinx

Additionally, CableLabs would like to thank the DCA MSO team for their continued support in driving the specification development and the decision-making process.

Jon Schnoor and Karthik Sundareshan, CableLabs

Appendix III Revision History

Engineering Change for CM-SP-R-UEPI-I02-160121

ECN	Date Accepted	Summary	Author
R-UEPI-N-15.1408-1	12/16/2015	HCS/CRC checking for SC-QAM channels	Pantelias

Engineering Changes for CM-SP-R-UEPI-I03-160512

ECN	Date Accepted	Summary	Author
R-UEPI-N-16.1474-1	4/21/2016	Probe Pseudowire Padding for Field Alignment	Pantelias
R-UEPI-N-16.1479-1	4/21/2016	OFDMA RNG-REQ pseudowire usage clarification	Pantelias
R-UEPI-N-16.1480-1	4/21/2016	UEPI Request Pseudowire informative clarification	Pantelias

Engineering Changes for CM-SP-R-UEPI-I04-160923

ECN	Date Accepted	Summary	Author
R-UEPI-N-16.1531-1	6/16/2016	Probe Pseudowire Padding for Field Alignment	Pantelias
R-UEPI-N-16.1535-1	6/23/2016	Clarify the usage requirements for request pseudowires	Sowinski
R-UEPI-N-16.1582-2	9/1/2016	Configuration needed for mapping Timing Error and MER (RPHY-155)	Huang
R-UEPI-N-16.1583-1	9/1/2016	RPD ignoring piggyback requests in a DOCSIS header	EIBakoury

Engineering Changes for CM-SP-R-UEPI-I05-170111

ECN	Date Accepted	Summary	Author
R-UEPI-N-16.1633-1	11/10/2016	UEPI PHY Latency for OFDMA	Pantelias
R-UEPI-N-16.1652-1	12/11/2016	R-UEPI - move tech requirements out of tables	Schnoor
R-UEPI-N-16.1664-1	12/15/2016	UEPI B/W request aggregation controls	Sowinski
R-UEPI-N-16.1677-2	12/15/2016	R-UEPI Editorial Changes	Huang

Engineering Change for CM-SP-R-UEPI-I06-170510

ECN	Date Accepted	Summary	Author
R-UEPI-N-16.1687-3	1/12/2017	Ranging Trailer Clarifications for SC-QAM	Pantelias

Engineering Change for CM-SP-R-UEPI-I07-170906

ECN	Date Accepted	Summary	Author
R-UEPI-N-17-1768-2	7/27/2017	Specification of PNM Types in PNM Transmission Unit Header	Hou

Engineering Change for CM-SP-R-UEPI-I08-171220

ECN	Date Accepted	Summary	Author
R-UEPI-N-17-1820-2	11/9/2017	Clarification of the use of RNG-REQ pseudowire	Sowinski

Engineering Change for CM-SP-R-UEPI-I09-180926

ECN	Date Accepted	Summary	Author
R-UEPI-N-18.1951-2	8/30/2018	R-UEPI Compilation	Schnoor

Engineering Change for CM-SP-R-UEPI-I10-190307

ECN	Date Accepted	Summary	Author
R-UEPI-N-18.1968-1	11/15/2018	Clarifications of the causes and actions associated with No Burst events	Young
R-UEPI-N-19.2000-2	2/7/2019	R-UEPI Compilation I10 Candidate	Schnoor

Engineering Change for CM-SP-R-UEPI-I11-190912

ECN	Date Accepted	Summary	Author
R-UEPI-N-19.204-2	8/22/2019	R-UEPI Compilation I11 Candidate	Schnoor

* * *