

Data-Over-Cable Service Interface Specifications DOCSIS® 4.0

Physical Layer Specification

CM-SP-PHYv4.0-I03-201202

ISSUED

Notice

This DOCSIS specification is the result of a cooperative effort undertaken at the direction of Cable Television Laboratories, Inc. for the benefit of the cable industry and its customers. You may download, copy, distribute, and reference the documents herein only for the purpose of developing products or services in accordance with such documents, and educational use. Except as granted by CableLabs® in a separate written license agreement, no license is granted to modify the documents herein (except via the Engineering Change process), or to use, copy, modify or distribute the documents for any other purpose.

This document may contain references to other documents not owned or controlled by CableLabs. Use and understanding of this document may require access to such other documents. Designing, manufacturing, distributing, using, selling, or servicing products, or providing services, based on this document may require intellectual property licenses from third parties for technology referenced in this document. To the extent this document contains or refers to documents of third parties, you agree to abide by the terms of any licenses associated with such third-party documents, including open source licenses, if any.

© Cable Television Laboratories, Inc. 2019 - 2020

DISCLAIMER

This document is furnished on an "AS IS" basis and neither CableLabs nor its members provides any representation or warranty, express or implied, regarding the accuracy, completeness, noninfringement, or fitness for a particular purpose of this document, or any document referenced herein. Any use or reliance on the information or opinion in this document is at the risk of the user, and CableLabs and its members shall not be liable for any damage or injury incurred by any person arising out of the completeness, accuracy, or utility of any information or opinion contained in the document.

CableLabs reserves the right to revise this document for any reason including, but not limited to, changes in laws, regulations, or standards promulgated by various entities, technology advances, or changes in equipment design, manufacturing techniques, or operating procedures described, or referred to, herein.

This document is not to be construed to suggest that any company modify or change any of its products or procedures, nor does this document represent a commitment by CableLabs or any of its members to purchase any product whether or not it meets the characteristics described in the document. Unless granted in a separate written agreement from CableLabs, nothing contained herein shall be construed to confer any license or right to any intellectual property. This document is not to be construed as an endorsement of any product or company or as the adoption or promulgation of any guidelines, standards, or recommendations.

Document Status Sheet

Document Control Number:	CM-SP-PHYv4.0-I03-201202			
Document Title:	Physical Layer Specification			
Revision History:	D01 – Released 6/28/2019 I01 – Released 8/15/2019 I02 – Released 4/29/2020 I03 – Released 12/02/20			
Date:	December 2, 2020			
Status:	Work in Progress	Draft	Issued	Closed
Distribution Restrictions:	Author Only	CL/Member	CL/Member/Vendor	Public

Key to Document Status Codes

Work in Progress	An incomplete document, designed to guide discussion and generate feedback that may include several alternative requirements for consideration.
Draft	A document in specification format considered largely complete, but lacking review by Members and vendors. Drafts are susceptible to substantial change during the review process.
Issued	A generally public document that has undergone Member and Technology Supplier review, cross-vendor interoperability, and is for Certification testing if applicable. Issued Specifications are subject to the Engineering Change Process.
Closed	A static document, reviewed, tested, validated, and closed to further engineering changes.

Trademarks

CableLabs® is a registered trademark of Cable Television Laboratories, Inc. Other CableLabs marks are listed at <http://www.cablelabs.com/certqual/trademarks>. All other marks are the property of their respective owners.

Table of Contents

1	SCOPE.....	8
1.1	Introduction and Purpose.....	8
1.2	Background.....	8
1.2.1	<i>Broadband Access Network</i>	8
1.2.2	<i>Network and System Architecture</i>	9
1.2.3	<i>Service Goals</i>	10
1.2.4	<i>Statement of Compatibility</i>	10
1.2.5	<i>Reference Architecture</i>	11
1.2.6	<i>DOCSIS 4.0 Documents</i>	11
1.3	Requirements.....	12
1.4	Conventions.....	13
1.5	Organization of Document.....	13
2	REFERENCES.....	14
2.1	Normative References.....	14
2.2	Informative References.....	15
2.3	Reference Acquisition.....	15
3	TERMS AND DEFINITIONS.....	16
4	ABBREVIATIONS AND ACRONYMS.....	28
5	OVERVIEW AND FUNCTIONAL ASSUMPTIONS.....	33
5.1	Overview.....	33
5.2	Functional Assumptions.....	33
5.2.1	<i>Equipment Assumptions</i>	33
5.2.2	<i>RF Channel Assumptions</i>	35
5.2.3	<i>Transmission Levels</i>	36
5.2.4	<i>Frequency Inversion</i>	36
6	PHY SUBLAYER FOR SC-QAM.....	37
6.1	Scope.....	37
6.2	Upstream Transmit and Receive.....	37
6.2.1	<i>Overview</i>	37
6.2.2	<i>Signal Processing Requirements</i>	37
6.2.3	<i>Modulation Formats</i>	37
6.2.4	<i>R-S Encode</i>	37
6.2.5	<i>Upstream R-S Frame Structure (Multiple Transmit Channel Mode Enabled)</i>	37
6.2.6	<i>Upstream R-S Frame Structure (Multiple Transmit Channel Mode Disabled)</i>	37
6.2.7	<i>TDMA Byte Interleaver</i>	37
6.2.8	<i>Scrambler (randomizer)</i>	38
6.2.9	<i>TCM Encoder</i>	38
6.2.10	<i>Preamble Prepend</i>	38
6.2.11	<i>Modulation Rates</i>	38
6.2.12	<i>S-CDMA Framers and Interleaver</i>	38
6.2.13	<i>S-CDMA Framers</i>	38
6.2.14	<i>Symbol Mapping</i>	38
6.2.15	<i>S-CDMA Spreader</i>	38
6.2.16	<i>Transmit Pre-Equalizer</i>	38
6.2.17	<i>Spectral Shaping</i>	38
6.2.18	<i>Relative Processing Delays</i>	38
6.2.19	<i>Transmit Power Requirements</i>	38
6.2.20	<i>Burst Profiles</i>	38
6.2.21	<i>Burst Timing Convention</i>	38

6.2.22	<i>Fidelity Requirements</i>	39
6.2.23	<i>Upstream Demodulator Input Power Characteristics</i>	39
6.2.24	<i>Upstream Electrical Output from the CM</i>	39
6.2.25	<i>Upstream CM Transmitter Capabilities</i>	39
6.3	Downstream Transmit	40
6.3.1	<i>Downstream Protocol</i>	40
6.3.2	<i>Spectrum Format</i>	40
6.3.3	<i>Scalable Interleaving to Support Video and High-Speed Data Services</i>	40
6.3.4	<i>Downstream Frequency Plan</i>	40
6.3.5	<i>DRFI Output Electrical</i>	40
6.3.6	<i>CMTS or EQAM Clock Generation</i>	40
6.3.7	<i>Downstream Symbol Clock Jitter for Synchronous Operation</i>	40
6.3.8	<i>Downstream Symbol Clock Drift for Synchronous Operation</i>	40
6.3.9	<i>Timestamp Jitter</i>	41
6.4	Downstream Receive	41
6.4.1	<i>Downstream Protocol and Interleaving Support</i>	41
6.4.2	<i>Downstream Electrical Input to the CM</i>	41
6.4.3	<i>CM BER Performance</i>	41
6.4.4	<i>Downstream Multiple Receiver Capabilities</i>	41
6.4.5	<i>Non-Synchronous DS Channel Support</i>	41
7	PHY SUBLAYER FOR OFDM	42
7.1	Scope	42
7.2	PHY Sublayer for FDX OFDM	42
7.2.1	<i>Full Duplex Node Reference Interfaces</i>	43
7.2.2	<i>Upstream and Downstream Frequency Plan</i>	43
7.2.3	<i>FDX OFDM Numerology</i>	47
7.2.4	<i>Upstream Transmit and Receive</i>	47
7.2.5	<i>FDX Downstream Transmit and Receive</i>	67
7.2.6	<i>Sounding</i>	84
7.2.7	<i>Echo Cancellation at the Cable Modem</i>	89
7.2.8	<i>Triggered RxMER Measurements</i>	93
7.3	PHY Sublayer for FDD OFDM	95
7.3.1	<i>FDD Node Reference Interfaces</i>	96
7.3.2	<i>Upstream and Downstream Frequency Plan for FDD Operation</i>	97
7.3.3	<i>FDD OFDM Numerology</i>	102
7.3.4	<i>Upstream Transmit and Receive</i>	102
7.3.5	<i>FDD Downstream Transmit and Receive</i>	123
8	PHY-MAC CONVERGENCE	137
9	PROACTIVE NETWORK MAINTENANCE	138
APPENDIX I	ICI FROM CWT SOUNDING SIGNAL (INFORMATIVE)	139
I.1	<i>ICI Caused by Sounding Signal on Adjacent US Subcarriers</i>	139
I.2	<i>ICI Caused by Sounding Signal on Adjacent DS Subcarriers</i>	139
APPENDIX II	EXAMPLE USE OF CWT SOUNDING TO FORM IGS (INFORMATIVE)	141
APPENDIX III	CMTS PROPOSED CONFIGURATION PARAMETERS (INFORMATIVE)	142
APPENDIX IV	FDD RPD/RMD RF OUTPUT PROFILES AT INTERFACE C (INFORMATIVE)	143
APPENDIX V	ACKNOWLEDGEMENTS (INFORMATIVE)	145
APPENDIX VI	REVISION HISTORY (INFORMATIVE)	146

List of Figures

Figure 1 - The DOCSIS Network.....	9
Figure 2 - Transparent IP Traffic through the Data-Over-Cable System	10
Figure 3 - DOCSIS 4.0 Distributed CMTS Reference Architecture	11
Figure 4 - Full Duplex Node Reference Interfaces.....	43
Figure 5 - Configurable FDX Allocated Spectrum Bandwidths	46
Figure 6 - FDX Cable Modem Upstream Power and Fidelity Measurements at Interface F	49
Figure 7 - Set-up for the FDX Node Packet-Error-Ratio Performance Test	66
Figure 8 - Spectrum at Interface D for the Node Receiver PER Test	67
Figure 9 - Downstream Power Profile with D dB Step-down at f_D MHz.....	69
Figure 10 - FDX Node Downstream Power Measurement at Interface D.....	70
Figure 11 - Test Set-up for External ACI Test.....	79
Figure 12 - State 0 for the External ACI Test	80
Figure 13 - State 1 for the External ACI Test	80
Figure 14 - Time-varying ACI and AWGN for External ACI Test	80
Figure 15 - Test Set-up for Self ACI Test.....	81
Figure 16 - Time-varying ACI and AWGN for Self ACI Test	82
Figure 17 - CW Tone Power Ramp Up and Ramp Down in Start and End to Reduce ICI to Adjacent Subcarriers. 86	
Figure 18 - Cable Modem and Drop Cable Schematic.....	89
Figure 19 - ALI and ACI Illustrated in the Spectral Plane	90
Figure 20 - CM FDX Entry Sequence	90
Figure 21 - ZBL Block for Echo Cancellation.....	92
Figure 22 - Sounding Period for OUDP Method	93
Figure 23 - Generic Triggered Measurement.....	94
Figure 24 - FDD Node Reference Interfaces	97
Figure 25 - Configurable FDD Upstream Allocated Spectrum Bandwidths	101
Figure 26 - FDD Cable Modem Upstream Power and Fidelity Measurements at Interface F	104
Figure 27 - Downstream Power RPD Step Down with D dB at F(D) MHz.....	125
Figure 28 - Example Transmission Profile at Interface C (Single Step-down at 1218 MHz).....	143
Figure 29 - Example Transmission Profile at Interface C (Multiple Step-down).....	144
Figure 30 - Example Transmission Profile at Interface C (Step-up).....	144
Figure 31 - Example Transmission Profile at Interface C (Single 6-dB Step-down at 1002 MHz)	144

List of Tables

Table 1 - DOCSIS 4.0 Series of Specifications.....	12
Table 2 - DOCSIS 4.0 Related Specifications	12
Table 3 - Typical Downstream RF Channel Transmission Characteristics	35
Table 4 - Typical Upstream RF Channel Transmission Characteristics.....	36
Table 5 - CM Transmitter Output Signal Characteristics for SC-QAM channels	39
Table 6 - Minimum CNR Performance 804 MHz to 1002 MHz for FDX CM Operating in FDX Mode	41
Table 7 - Channel Resources for FDX Devices	44
Table 8 - Reference PSD and Tilt (FDX)	51

Table 9 - Spurious Emissions.....	59
Table 10 - Spurious Emissions Requirements in the Upstream Frequency Range for Grants of Under-grant Hold Bandwidth and Larger.....	61
Table 11 - Upstream MER Requirements (with Pre-Equalization).....	63
Table 12 - Upstream MER Requirements (no Pre-Equalization).....	63
Table 13 - CM Transmitter Output Signal Characteristics for the FDX Band	64
Table 14 - Peak Return Loss	66
Table 15 - Average Return Loss.....	66
Table 16 - Node Minimum CNR Performance in FDX Channel.....	67
Table 17 - Required Power Drop-down to Achieve Target TCP of 71 and 72 dBmV	71
Table 18 - RF Output Electrical Requirements.....	72
Table 19 - FDX Node Output Power.....	74
Table 20 - FDX Node Output Out-of-Band Noise and Spurious Emissions Requirements.....	76
Table 21 - Electrical Input to FDX CM.....	78
Table 22 - CNR Performance Requirement of an FDX CM for External-ACI Test.....	81
Table 23 - CNR Performance Requirement of FDX CM for Self ACI Test	82
Table 24 - TPER and TON for the Two Sets of Tests.....	83
Table 25 - FDX CM in FDX Mode Minimum CNR Performance in AWGN Channel.....	83
Table 26 - Channel Sounding Methods for Test-Measurer CM Combinations	84
Table 27 - Worst Case ICI for Ramped CW Tones Relative to Average DS Data Subcarrier Power	86
Table 28 - Fractional Frequency Offset as a Function of Phase Rotation, N_{cp} and Subcarrier Spacing	88
Table 29 - DOCSIS 4.0 FDD Band Edges and Device Applicability	98
Table 30 - Channel Resources for FDD Devices	98
Table 31 - FDD CM Diplex Filter Band Edge Frequencies	99
Table 32 -Upstream Reference PSD, TCP, and Spectral Tilt Values for Different FDD Modes	106
Table 33 - Spurious Emissions for FDD CM.....	115
Table 34 - FDD Spurious Emissions Requirements in the Upstream Frequency Range for Grants of Under-grant Hold Bandwidth and Larger	117
Table 35 - Upstream MER Requirements (with Pre-Equalization).....	119
Table 36 - Upstream MER Requirements (no Pre-Equalization).....	119
Table 37 - FDD CM Transmitter Output Signal Characteristics	120
Table 38 - FDD RMD/RPD Upstream Channel Demodulator Input Power Characteristics.....	121
Table 39 - FDD RMD/RPD Minimum CNR Performance in AWGN Channel.....	122
Table 40 - FDD RMD/RPD RF Output Electrical Requirements	125
Table 41 - FDD RMD/RPD Output Power.....	128
Table 42 - FDD RMD/RPD Output Out-of-Band Noise and Spurious Emissions Requirements	132
Table 43 - Electrical Input to FDD CM.....	133
Table 44 - CM Minimum CNR Performance ¹ in AWGN Channel for 1218 MHz Input Signal Upper Frequency Limit.....	135
Table 45 - CM Minimum CNR Performance ¹ in AWGN Channel for 1794 MHz Input Signal Upper Frequency Limit.....	135
Table 46 - Inter-Carrier Interference	140
Table 47 - CMTS Proposed Configuration Parameters.....	142

1 SCOPE

1.1 Introduction and Purpose

This specification is part of the DOCSIS family of specifications developed by Cable Television Laboratories (CableLabs). In particular, this specification is part of a series of specifications that defines the sixth generation of high-speed data-over-cable systems, commonly referred to as the DOCSIS 4.0 specifications. This specification was developed for the benefit of the cable industry, and includes contributions by operators and vendors from North and South America, Europe, China, and other regions.

This generation of the DOCSIS specifications builds upon the previous generations of DOCSIS specifications (commonly referred to as the DOCSIS 3.1 and earlier specifications), leveraging the existing Media Access Control (MAC) and Physical (PHY) layers. It includes backward compatibility for the existing PHY layers in order to enable a seamless migration to the new technology. Further, the DOCSIS 4.0 specifications introduces Full Duplex (FDX) DOCSIS PHY layer technology as an expansion of the OFDM PHY layer introduced in the [DOCSIS PHYv3.1] specification to increase upstream capacity without significant loss of downstream capacity versus DOCSIS 3.1. The DOCSIS 4.0 specification also builds upon DOCSIS 3.1 OFDM and OFDMA technology with an extended Frequency Division Duplex (FDD) DOCSIS alternative. DOCSIS 4.0 FDD supports legacy high-split and also provides extended splits up to 684 MHz in an operational band plan which is referred to as Ultra-high Split (UHS). DOCSIS 4.0 FDD also introduces expansion of usable downstream spectrum up to 1794 MHz. Both the FDX and FDD DOCSIS 4.0 alternatives are based on OFDM PHY. Many sections refer to basic OFDM sublayer definitions described in [DOCSIS PHYv3.1].

There are differences in the cable spectrum planning practices adopted for different networks in the world. For the PHY layer defined in this specification, there is flexibility to deploy the technology in any spectrum plan; therefore, no special accommodation for different regions of the world is required for this new PHY layer.

However, due to the inclusion of the DOCSIS 3.0 PHY layers for backward-compatibility purposes, there is still a need for different region-specific physical layer technologies. Therefore, three options for physical layer technologies are included in this specification, which have equal priority and are not required to be interoperable. One technology option is based on the downstream channel identification plan that is deployed in North America using 6 MHz spacing. The second technology option is based on the corresponding European multi-program television distribution. The third technology option is based on the corresponding Chinese multi-program television distribution. All three options have the same status, notwithstanding that the document structure does not reflect this equal priority. The first of these options is defined in Sections 5 and 6, whereas the second is defined by replacing the content of those sections with the content of annex C of [DOCSIS PHYv3.1]. The third is defined by replacing the content of those sections with the content of annex D of [DOCSIS PHYv3.1]. Correspondingly, [ITU-T J.83-B] and [CTA 542] apply only to the first option, and [EN 300 429] applies to the second and third. Compliance with this document requires compliance with one of these implementations, but not with all three. It is not required that equipment built to one option interoperate with equipment built to the others.

Compliance with frequency planning and EMC requirements is not covered by this specification and remains the operators' responsibility. In this respect, [FCC15] and [FCC76] are relevant to the USA; [CAN/CSA CISPR 22-10] and [ICES 003 Class A] to Canada; [EG 201 212], [EN 50083-1], [EN 50083-2], [EN 50083-7], [EN 61000-6-1], and [EN 61000-6-3] are relevant to the European Union; and [GB 8898-2011] and [GB/T 11318.1-1996] are relevant to China.

See also [DOCSIS PHYv3.1], section 1.1.

1.2 Background

1.2.1 Broadband Access Network

A coaxial-based broadband access network is assumed. This may take the form of either an all-coax or hybrid-fiber/coax (HFC) network. The generic term "cable network" is used here to cover all cases.

A cable network uses a tree-and-branch architecture with analog transmission. The key functional characteristics assumed in this document are the following:

- Two-way transmission.
- A maximum optical/electrical spacing between the CMTS and the most distant CM of 100 miles (160 km) in each direction, although typical maximum separation may be 10-15 miles (16-24 km).

1.2.2 Network and System Architecture

1.2.2.1 The DOCSIS Network

The elements that participate in the provisioning of DOCSIS services are shown in Figure 1.

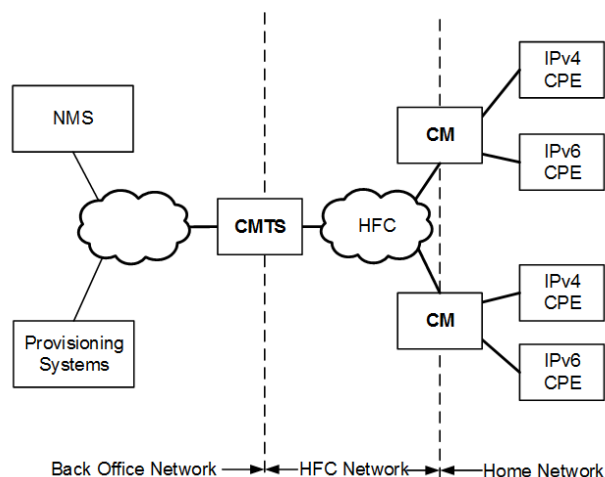

Figure 1 - The DOCSIS Network

The CM connects to the operator's HFC network and to a home network, bridging packets between them. Many CPE devices can connect to the CMs' LAN interfaces. CPE can be embedded with the CM in a single device, or they can be separated into standalone devices, as shown in Figure 1. CPE may use IPv4, IPv6 or both forms of IP addressing. Examples of typical CPE are gateways, home routers, set-top devices, personal computers, etc.

The CMTS connects the operator's back office and core network to the HFC network. The CMTS's main function is to forward packets between these two domains, and optionally to forward packets between upstream and downstream channels on the HFC network. The CMTS performs this forwarding with any combination of link-layer (bridging) and network-layer (routing) semantics.

For a DOCSIS 4.0 system, a distributed architecture is assumed. Thus, where DOCSIS 4.0 specifications use the "CMTS" terminology it is implied to refer to legacy CMTS functionality as instantiated in the elements of the distributed architecture.

Various applications are used to provide back office configuration and other support to the devices on the DOCSIS network. These applications use IPv4 and/or IPv6 as appropriate to the particular operator's deployment. The following applications include:

Provisioning Systems:

- The DHCP servers provide the CM with initial configuration information, including the device IP address(es), when the CM boots.
- The Configuration File server is used to download configuration files to CMs when they boot. Configuration files are in binary format and permit the configuration of the CM's parameters.
- The Software Download server is used to download software upgrades to the CM.
- The Time Protocol server provides Time Protocol clients, typically CMs, with the current time of day.
- The Certificate Revocation server provides certificate status.

Network Management System (NMS):

- The SNMP Manager allows the operator to configure and monitor SNMP Agents, typically the CM and the CMTS.
- The Syslog server collects messages pertaining to the operation of devices.
- The IPDR Collector server allows the operator to collect bulk statistics in an efficient manner.

1.2.3 Service Goals

As cable operators have widely deployed high-speed data services on cable television systems, the demand for bandwidth has increased. To this end, CableLabs' member companies have decided to add new features to the DOCSIS specification for the purpose of increasing capacity, increasing peak speeds, improving scalability, enhancing network maintenance practices, and deploying new service offerings.

The DOCSIS system allows transparent bi-directional transfer of Internet Protocol (IP) traffic, between the cable system headend and customer locations, over an all-coaxial or Hybrid-Fiber/Coax (HFC) cable network. This is shown in simplified form in Figure 2.

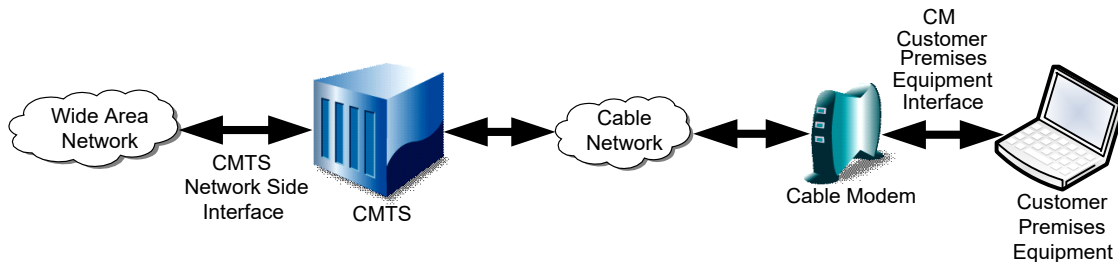

Figure 2 - Transparent IP Traffic through the Data-Over-Cable System

1.2.4 Statement of Compatibility

This specification defines the DOCSIS 4.0 interface. Prior generations of DOCSIS were commonly referred to as the DOCSIS 1.0, 1.1, 2.0, 3.0, and 3.1 interfaces. DOCSIS 4.0 is backward-compatible with some equipment built to the previous specifications. DOCSIS 4.0-compliant CMs interoperate seamlessly with DOCSIS 4.0, DOCSIS 3.1 and DOCSIS 3.0 CMTSs. DOCSIS 4.0-compliant CMTSs seamlessly support DOCSIS 4.0, DOCSIS 3.1, DOCSIS 3.0, DOCSIS 2.0, and DOCSIS 1.1 CMs.

1.2.5 Reference Architecture

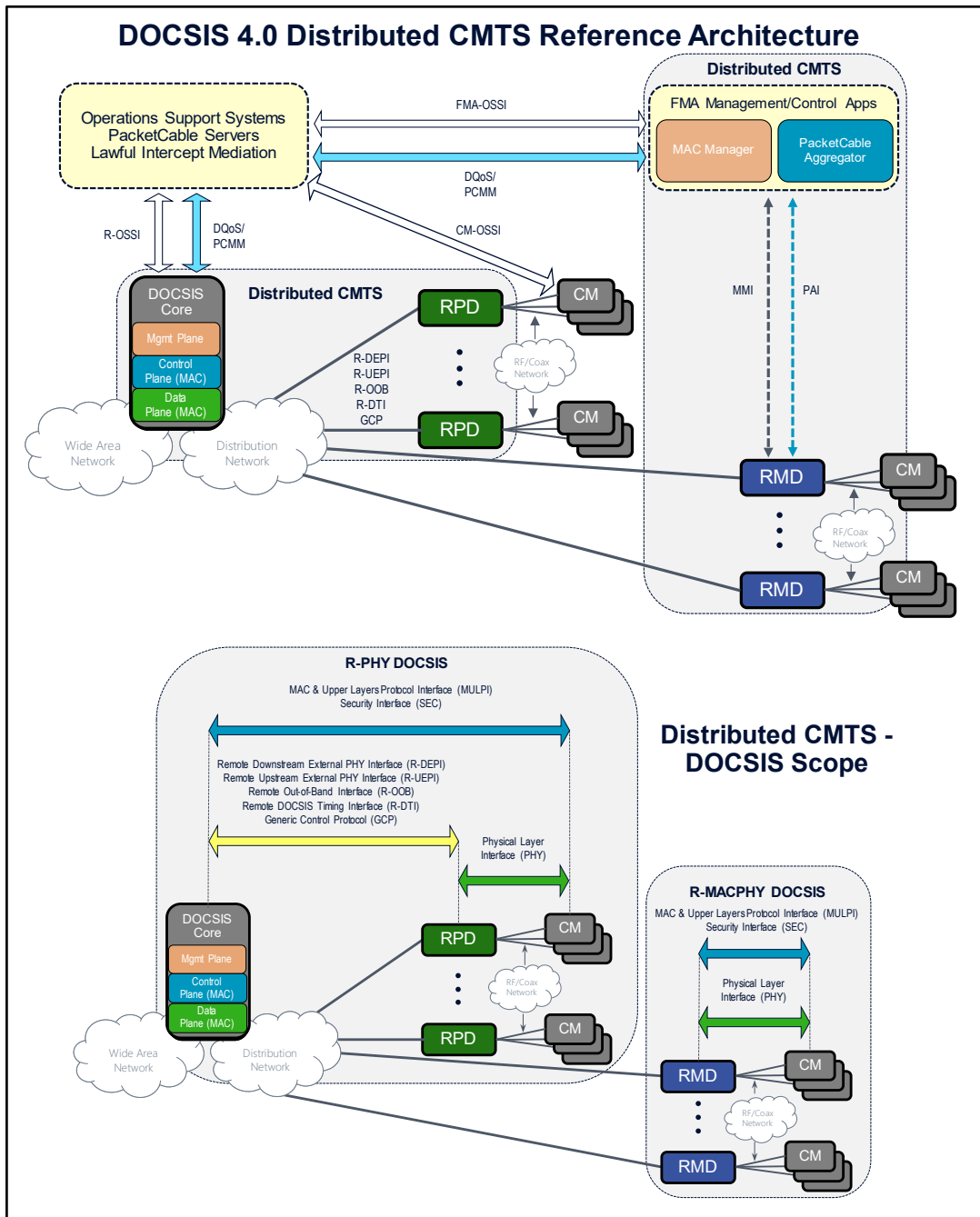

Figure 3 - DOCSIS 4.0 Distributed CMTS Reference Architecture

The reference architecture for data-over-cable services and interfaces is shown in Figure 3.

1.2.6 DOCSIS 4.0 Documents

A list of the specifications in the DOCSIS 4.0 series is provided in Table 1. For further information, please refer to <https://www.cablelabs.com/>.

Table 1 - DOCSIS 4.0 Series of Specifications

Designation	Title
CM-SP-PHYv4.0	Physical Layer Specification
CM-SP-MULPIv4.0	MAC and Upper Layer Protocols Interface Specification
CM-SP-CM-OSSiv4.0	Cable Modem Operations Support System Interface Specification
CM-SP-CCAP-OSSiv4.0	CCAP™ Operations Support System Interface Specification
CM-SP-SECv4.0	Security Specification

This specification defines the interface for the physical layer.

Related DOCSIS specifications are listed in Table 2.

Table 2 - DOCSIS 4.0 Related Specifications

Designation	Title
CM-SP-PHYv3.1	Physical Layer Specification
CM-SP-MULPIv3.1	MAC and Upper Layer Protocols Interface Specification
CM-SP-CM-OSSiv3.1	Cable Modem Operations Support System Interface Specification
CM-SP-CCAP-OSSiv3.1	CCAP Operations Support System Interface Specification
CM-SP-SECv3.1	Security Specification
CM-SP-CMCiv3.0	Cable Modem CPE Interface Specification
CM-SP-eDOCSIS	eDOCSIS™ Specification
CM-SP-DRFI	Downstream Radio Frequency Interface Specification
CM-SP-DTI	DOCSIS Timing Interface Specification
CM-SP-DEPI	Downstream External PHY Interface Specification
CM-SP-DSG	DOCSIS Set-Top Gateway Interface Specification
CM-SP-FMA-SYS	Flexible MAC Architecture System Specification
CM-SP-FMA-OSSI	Flexible MAC Architecture Operations Support System Interface Specification
CM-SP-FMA-MMI	Flexible MAC Architecture MAC Manager Interface Specification
CM-SP-FMA-PAI	Flexible MAC Architecture PacketCable Aggregator Interface Specification
CM-SP-GCP	Generic Control Plane Specification
CM-SP-L2VPN	Layer 2 Virtual Private Networks Specification
CM-SP-R-DEPI	Remote Downstream External PHY Interface Specification
CM-SP-R-DTI	Remote DOCSIS Timing Interface Specification
CM-SP-R-OOB	Remote Out-of-Band Specification
CM-SP-R-OSSI	Remote PHY OSS Interface Specification
CM-SP-R-PHY	Remote PHY Specification
CM-SP-R-UEPI	Remote Upstream External PHY Interface Specification
CM-SP-TEI	TDM Emulation Interfaces Specification

1.3 Requirements

Throughout this document, the words that are used to define the significance of particular requirements are capitalized. These words are:

"MUST"	This word means that the item is an absolute requirement of this specification.
"MUST NOT"	This phrase means that the item is an absolute prohibition of this specification.
"SHOULD"	This word means that there may exist valid reasons in particular circumstances to ignore this item, but the full implications should be understood, and the case carefully weighed before choosing a different course.

"SHOULD NOT"	This phrase means that there may exist valid reasons in particular circumstances when the listed behavior is acceptable or even useful, but the full implications should be understood, and the case carefully weighed before implementing any behavior described with this label.
"MAY"	This word means that this item is truly optional. One vendor may choose to include the item because a particular marketplace requires it or because it enhances the product, for example; another vendor may omit the same item.

This document defines many features and parameters, and a valid range for each parameter is usually specified. Equipment (CM and CMTS) requirements are always explicitly stated. Equipment is required to comply with all mandatory (MUST and MUST NOT) requirements to be considered compliant with this specification. Support of non-mandatory features and parameter values is optional.

1.4 Conventions

In this specification, the following convention applies any time a bit field is displayed in a figure. The bit field should be interpreted by reading the figure from left to right, then top to bottom, with the most-significant bit (MSB) being the first bit read, and the least-significant bit (LSB) being the last bit read.

1.5 Organization of Document

Section 1 provides an overview of the DOCSIS 4.0 series of specifications including the DOCSIS reference architecture and statement of compatibility.

Section 2 includes a list of normative and informative references used within this specification or related specifications.

Section 3 defines the terms used throughout this specification or related specifications.

Section 4 defines the abbreviations and acronyms used throughout this specification or related specifications.

Section 5 provides a technical overview and lists the key features of DOCSIS 4.0 technology for the functional area of this specification; it also describes the key functional assumptions for the DOCSIS 4.0 system.

Section 6 defines the PHY sublayer for SC-QAM.

Section 7 defines the interface and related requirements for operation with the DOCSIS 4.0 channels, as well as for combined operation of DOCSIS 3.0, DOCSIS 3.1 and DOCSIS 4.0 channels. This is addressed for each of: the CM downstream and upstream physical layer; and for the CMTS downstream upstream physical layer.

Section 8 defines PHY-MAC convergence - how information is transferred between the MAC layer and the PHY layer - in both the upstream and downstream.

Section 9 defines the requirements supporting Proactive Network Maintenance (PNM).

The appendices contain informative material that provides more detailed explanations and examples of certain aspects of this specification.

2 REFERENCES

2.1 Normative References

In order to claim compliance with this specification, it is necessary to conform to the following standards and other works as indicated, in addition to the other requirements of this specification. Notwithstanding, intellectual property rights may be required to use or implement such normative references.

All references are subject to revision, and parties to agreement based on this specification are encouraged to investigate the possibility of applying the most recent editions of the documents listed below.

[CAN/CSA CISPR 22-10]	Information technology equipment - Radio disturbance characteristics - Limits and methods of measurement (Adopted IEC CISPR 22:2008, sixth edition, 2008-09).
[DOCSIS DRFI]	Downstream Radio Frequency Interface Specification, CM-SP-DRFI-I16-170111, January 11, 2017, Cable Television Laboratories, Inc.
[DOCSIS MULPIv3.1]	DOCSIS 3.1, MAC and Upper Layer Protocols Interface Specification, CM-SP-MULPIv3.1-I21-201020, October 20, 2020, Cable Television Laboratories, Inc.
[DOCSIS MULPIv4.0]	DOCSIS 4.0, MAC and Upper Layer Protocols Interface Specification, CM-SP-MULPIv4.0-I03-201202, December 2, 2020, Cable Television Laboratories, Inc.
[DOCSIS PHYv3.0]	DOCSIS 3.0, Physical Layer Specification, CM-SP-PHYv3.0-C01-171207, December 07, 2017, Cable Television Laboratories, Inc.
[DOCSIS PHYv3.1]	DOCSIS 3.1, Physical Layer Specification, CM-SP-PHYv3.1-I17-190917, September 17, 2019, Cable Television Laboratories, Inc.
[DVB-C2]	ETSI EN 302 769 V1.2.1: Digital Video Broadcasting (DVB); Frame structure channel coding and modulation for a second generation digital transmission system for cable systems (DVB-C2), April 2011.
[EG 201 212]	ETSI EG 201 212 V1.2.1: Electrical safety; Classification of interfaces for equipment to be connected to telecommunication networks, November 1998.
[EN 300 429]	ETSI EN 300 429 V1.2.1: Digital Video Broadcasting (DVB); Framing structure, channel coding and modulation for cable systems, April 1998.
[EN 50083-1]	CENELEC EN 50083-1: Cable networks for television signals, sound signals and interactive services -- Part 1: Safety requirements, 2002.
[EN 50083-2]	CENELEC EN 50083-2: Cable networks for television signals, sound signals and interactive services -- Part 2: Electromagnetic compatibility for equipment, 2005.
[EN 50083-7]	CENELEC EN 50083-7: Cable networks for television signals, sound signals and interactive services -- Part 7: System performance, April 1996.
[EN 61000-6-1]	CENELEC EN 61000-6-4: Electromagnetic compatibility (EMC) -- Part 6-1: Generic standards - Immunity for residential, commercial and light-industrial environments, October 2001.
[EN 61000-6-3]	CENELEC EN 61000-6-3: Electromagnetic compatibility (EMC) -- Part 6-3: Generic standards - Emission standard for residential, commercial and light-industrial environments, 2003.
[FCC15]	Code of Federal Regulations, Title 47, Part 15, October 2005.
[FCC76]	Code of Federal Regulations, Title 47, Part 76, October 2005.
[GB 8898-2011]	Audio, video and similar electronic apparatus-Safety requirements, Standardization Administration of People's republic of China (SAC), www.sac.gov.cn
[ISO/IEC-61169-24]	ISO/IEC-61169-24, Radio-frequency connectors - Part 24: Sectional specification - Radio frequency coaxial connectors with screw coupling, typically for use in 75 ohm cable distribution systems (type F), 2001.
[ITU-T J.83-B]	Annex B to ITU-T Recommendation J.83 (12/2007), Digital multi-program systems for television sound and data services for cable distribution.
[SCTE 02]	ANSI/SCTE 02, Specification for "F" Port, Female Indoor, 2015.
[SCTE 91]	ANSI/SCTE 91, Specification for 5/8-24 RF & AC Equipment Port, Female, 2015.
[SCTE RMP]	TS46, SCTE Measurement Recommended Practices for Cable Systems, Fourth Edition, March 2012, http://www.scte.org/ItemDetail?iProductCode=TS46 .

2.2 Informative References

This specification uses the following informative references.

[CMB1993]	G. Castagnoli, S. Bräuer, and M. Herrmann, "Optimization of Cyclic Redundancy-Check Codes with 24 and 32 Parity Bits", IEEE Transactions on Communications, vol. 41, No. 6, pp. 883-892, June 1993.
[CTA 542]	Cable Television Channel Identification Plan, CTA-542-D, Consumer Technology Association standard, June 2013
[DOCSIS CCAP-OSSiv3.1]	DOCSIS 3.1 CCAP Operations Support System Interface Specification, CM-SP-CCAP-OSSiv3.1-I19-201022, October 22, 2020, Cable Television Laboratories, Inc.
[DOCSIS CM-OSSiv3.1]	DOCSIS 3.1 Cable Modem Operations Support System Interface Specification, CM-SP-CM-OSSiv3.1-I18-201022, October 22, 2020, Cable Television Laboratories, Inc.
[GB/T 11318.1-1996]	Equipment and components used in cabled distribution systems primarily intended for television and sound signals--Part 1: Generic specifications, China Zhijian Publish House SAC.
[ICES 003 Class A]	Information Technology Equipment (ITE) — Limits and methods of measurement.
[PHYv3.1 CODECHECK]	CM-PHYv3.1_CODECHECK-131029, Number and size of codewords versus grant sizes, Cable Television Laboratories, Inc. https://apps.cablelabs.com/specification/CM-SP-PHYv3.1
[PHYv3.1 QAM]	PHYv3.1QAM Mapping, bit to constellation symbol mapping for DOCSIS 3.1, April 2014, https://apps.cablelabs.com/specification/CM-SP-PHYv3.1
[NodePortEchoResponse]	CM-PHYv3.1_NodePortEchoResponse-171005.xlsx, Node Port Echo Response https://apps.cablelabs.com/specification/CM-SP-PHYv3.1
[R-PHY]	Remote PHY Specification, CM-SP-R-PHY-I14-200323, March 23, 2020, Cable Television Laboratories, Inc.

2.3 Reference Acquisition

- Cable Television Laboratories, Inc., 858 Coal Creek Circle, Louisville, CO 80027; Phone +1-303-661-9100; Fax +1-303-661-9199; <http://www.cablelabs.com>
- CENELEC: European Committee for Electro-technical Standardization, <http://www.cenelec.eu>
- Consumer Technology Association, <https://www.cta.tech/Research-Standards.aspx>
- Ecma International: <http://www.ecma-international.org/>
- ETSI: European Telecommunications Standards Institute, <http://www.etsi.org/standards>
- IETF: Internet Engineering Task Force Secretariat, 48377 Fremont Blvd., Suite 117, Fremont, California 94538, USA, Phone: +1-510-492-4080, Fax: +1-510-492-4001, <http://www.ietf.org>
- ISO: International Organization for Standardization (ISO), <https://www.iso.org/home.html>
- ITU: International Telecommunications Union (ITU), <http://www.itu.int/home/contact/index.html>
- SCTE•ISBE: Society of Cable Telecommunications Engineers Inc., 140 Philips Road, Exton, PA 19341; Phone: 610-363-6888 / 800-542-5040; Fax: 610-363-5898; <http://www.scte.org/>

3 TERMS AND DEFINITIONS

This specification uses the following terms:

100% Grant	The amount of Occupied Bandwidth in the TCS or TCS_FDX (see Occupied Bandwidth). There is a separate, different 100% grant for (legacy) TCS and TCS_FDX.
Active Channel	Any channel which has been assigned to a cable modem's transmit channel set either in a registration response message or a dynamic bonding request message, and prior to registration. After registration, the set of active channels also is called the transmit channel set. If the CMTS needs to add, remove, or replace channels in the cable modem's transmit channel set, it uses the dynamic bonding request message with transmit channel configuration encodings to define the desired new transmit channel set. Note that the set of channels actually bursting upstream from a cable modem is a subset of that cable modem's active channels. In many instances one or all of a cable modem's active channels will not be bursting, but such quiet channels are still considered active channels for that cable modem.
Active Subcarrier	1) In a downstream OFDM channel, any subcarrier other than an excluded subcarrier. 2) In an upstream OFDMA channel, any subcarrier other than an excluded subcarrier (subcarriers in zero-valued minislots as defined in OFDMA profiles, and unused subcarriers are considered active subcarriers because they are used in probes).
Adaptive Equalizer	A circuit in a digital receiver that compensates for channel response impairments. In effect, the circuit creates a digital filter that has approximately the opposite complex frequency response of the channel through which the desired signal was transmitted.
Adaptive Equalizer Tap	See <i>tap</i> .
Adaptive Pre-Equalizer	A circuit in a DOCSIS 1.1 or newer cable modem that pre-equalizes or pre-distorts the transmitted upstream signal to compensate for channel response impairments. In effect, the circuit creates a digital filter that has approximately the opposite complex frequency response of the channel through which the desired signal is to be transmitted.
Additive White Gaussian Noise	See thermal noise.
Availability	The ratio of time that a service, device, or network is available for use to total time, usually expressed as a percentage of the total time. For example, four-nines availability, written as 99.99%, means that a service is available 8759.12 hours out of 8760 total hours in a year.
BCH	A class of error correction codes named after the inventors Raj Bose, D. K. Ray-Chaudhuri, and Alexis Hocquenghem.
Binary Phase Shift Keying	A form of digital modulation in which two phases separated by 180 degrees support the transmission of one bit per symbol.
Bit Error Rate	See bit error ratio.
Bit Error Ratio	The ratio of errored bits to the total number of bits transmitted, received, or processed over a defined amount of time. Mathematically, $BER = (\text{number of errored bits}) / (\text{total number of bits})$ or $BER = (\text{error count in measurement period}) / (\text{bit rate} * \text{measurement period})$. Usually expressed in scientific notation format. Also called bit error rate.
Bit Loading	The technique of assigning the optimum number of bits (modulation order) for transmission per subcarrier in an OFDM or OFDMA system.
Burst	A single continuous RF signal from the cable modem upstream transmitter, from transmitter on to transmitter off.
Burst Noise	1) Another name for impulse noise. 2) A type of noise comprising random and sudden step-like changes between levels, often occurring in semiconductors. Sometimes called popcorn noise.
Cable Modem	A modulator-demodulator at the subscriber premises intended for use in conveying data communications on a cable television system.
Cable Modem Termination System	A device located at the cable television system headend or distribution hub, which provides complementary functionality to the cable modems to enable data connectivity to a wide-area network.

Carrier-To-Noise Ratio	<p>1) The ratio of signal (or carrier) power to noise power in a defined measurement bandwidth.</p> <p>2) For OFDM and OFDMA signals, the ratio of average signal power (P_{SIGNAL}) in the occupied bandwidth to the average noise power in the occupied bandwidth given by the noise power spectral density integrated over the same occupied bandwidth, expressed mathematically as $\text{CNR} = 10 \log_{10} [P_{\text{SIGNAL}} / N(f)df]$ dB. Note: This is a lower bound on the actual received signal-to-noise ratio.</p> <p>3) For SC-QAM, the ratio of the average signal power (P_{SIGNAL}) to the average noise power in the QAM signal's symbol rate bandwidth (N_{SYM}), and expressed mathematically as $\text{CNR} = 10 \log_{10}(P_{\text{SIGNAL}}/N_{\text{SYM}})$ dB or equivalently for an AWGN channel as $\text{CNR} = 10 \log_{10}(E_s/N_0)$ dB. Note: For an AWGN channel,</p> $P_{\text{SIGNAL}}/N_{\text{SYM}} = (E_s/T_s)/(N_0 B_N) = (E_s/T_s)/(N_0/T_s) = E_s/N_{0i},$ <p>where E_s and T_s are the symbol energy and duration respectively, N_0 is the noise power spectral density, and B_N is the noise bandwidth equal to the symbol rate bandwidth $1/T_s$.</p> <p>4) For analog television signals, the ratio of visual carrier peak envelope power during the transmission of synchronizing pulses (P_{PEP}) to noise power (N), where the visual carrier power measurement bandwidth is nominally 300 kHz and the noise power measurement bandwidth is 4 MHz for NTSC signals. For the latter, the noise measurement bandwidth captures the total noise power present over a 4 MHz band centered within the television channel, and is expressed mathematically as $\text{CNR} = 10 \log_{10}(P_{\text{PEP}}/N)$ dB. Note: For analog PAL and SECAM channels, the noise measurement bandwidth is a larger value than the 4 MHz specified for NTSC (4.75 MHz, 5.00 MHz, 5.08 MHz, or 5.75 MHz, depending on the specific system).</p>
CEA-542	A Consumer Electronics Association standard that defines a channel identification plan for 6 MHz-wide channel frequency allocations in cable systems.
Ceiling	A mathematical function that returns the lowest-valued integer that is greater than or equal to a given value.
Channel	A portion of the electromagnetic spectrum used to convey one or more RF signals between a transmitter and receiver. May be specified by parameters such as center frequency, bandwidth, or CEA channel number.
Codeword	Forward error correction data block, comprising a combination of information bytes and parity bytes.
Codeword Error Ratio	The ratio of errored codewords to the total number of codewords transmitted, received, or processed over a defined amount of time. Mathematically, $\text{CER} = (\text{number of errored codewords})/(\text{total number of codewords})$. Usually expressed in scientific notation format.
Coefficient	Complex number that establishes the gain of each tap in an adaptive equalizer or adaptive pre-equalizer.
Common Path Distortion	Clusters of second and third order distortion beats generated in a diode-like nonlinearity such as a corroded connector in the signal path common to downstream and upstream. The beats tend to be prevalent in the upstream spectrum. When the primary RF signals are digitally modulated signals instead of analog TV channels, the distortions are noise-like rather than clusters of discrete beats.
Complementary Pilots	Subcarriers that carry data, but with a lower modulation order than other data subcarriers in a given minislots. Complementary pilots allow phase tracking along the time axis for frequency offset and phase noise correction, and may be used by the CMTS upstream receiver to enhance signal processing, such as improving the accuracy of center frequency offset acquisition.
Composite Second Order	Clusters of second order distortion beats generated in cable network active devices that carry multiple RF signals. When the primary RF signals are digitally modulated signals instead of analog TV channels, the distortions are noise-like rather than clusters of discrete beats.
Composite Triple Beat	Clusters of third order distortion beats generated in cable network active devices that carry multiple RF signals. When the primary RF signals are digitally modulated signals instead of analog TV channels, the distortions are noise-like rather than clusters of discrete beats.
Continuous Pilots	Pilots that occur at the same frequency location in every OFDM symbol, and which are used for frequency and phase synchronization.
Convolution	A process of combining two signals in which one of the signals is time-reversed and correlated with the other signal. The output of a filter is the convolution of its impulse response with the input signal.
Convolutional Interleaver	An interleaver in which symbols are sequentially shifted into a bank of "I" registers. Each successive register has "J" symbols more storage than the preceding register. The first interleaver path has zero delay, the second has a J symbol period of delay, the third $2 \times J$ symbol periods of delay, etc., up to the I^{th} path which has $(I - 1) \times J$ symbol periods of delay. This process is reversed in the receiver's deinterleaver so that the net delay of each symbol is the same through the interleaver and deinterleaver. See also <i>interleaver</i> .
Correlation	<p>1) A process of combining two signals in which the signals are multiplied sample-by-sample and summed; the process is repeated at each sample as one signal is slid in time past the other.</p> <p>2) Cross-correlation is a measure of similarity between two signals.</p>
Cross Modulation	A form of television signal distortion in which modulation from one or more television signals is imposed on another signal or signals.

Customer Premises Equipment	Device such as a cable modem or set-top at the subscriber's or other end user's location. May be provided by the end user or the service provider.
Cyclic Prefix	A copy of the end of a symbol that is added to the beginning of the same symbol, in order to help mitigate the effects of micro-reflections and similar impairments.
Data-Subcarrier	The ratio of the time-average power of a single data subcarrier to the underlying noise power, with the noise measured in a bandwidth equal to the nominal subcarrier spacing.
Decibel	Ratio of two power levels expressed mathematically as $\text{dB} = 10\log_{10}(P_1/P_2)$.
Decibel Carrier	Ratio of the power of a signal to the power of a reference carrier, expressed mathematically as $\text{dBC} = 10\log_{10}(P_{\text{signal}}/P_{\text{carrier}})$.
Decibel Millivolt	Unit of RF power expressed in terms of voltage, defined as decibels relative to 1 millivolt, where 1 millivolt equals 13.33 nanowatts in a 75 ohm impedance. Mathematically, $\text{dBmV} = 20\log_{10}(\text{value in mV}/1 \text{ mV})$.
Decibel Reference	Ratio of a signal level to a reference signal level, when the signals are noise or noise-like; the density units measurement bandwidth for the two signals is the same. When both signal levels are in the same units of power, the ratio is expressed mathematically as $\text{dBr} = 10\log_{10}(P_{\text{signal}}/P_{\text{reference}})$. When both signal levels are in the same units of voltage, assuming the same impedance, the ratio is expressed mathematically as $\text{dBr} = 20\log_{10}(V_{\text{signal}}/V_{\text{reference}})$.
Discrete Fourier Transform	Part of the family of mathematical methods known as Fourier analysis, which defines the "decomposition" of signals into sinusoids. Discrete Fourier transform defines the transformation from the time to the frequency domain. See also <i>inverse discrete Fourier transform</i> .
Distortion	See linear distortion and nonlinear distortion.
Distribution Hub	A facility in a cable network which performs the functions of a headend for customers in its immediate area, and which receives some or all of its content for transmission from a master headend in the same metropolitan or regional area.
DOCSIS	Data-Over-Cable Service Interface Specifications. A group of specifications that defines interoperability between cable modem termination systems and cable modems.
DOCSIS 1.x	Abbreviation for DOCSIS versions 1.0 or 1.1.
Downstream	1) The direction of RF signal transmission from headend or hub site to subscriber. 2) For DOCSIS 4.0, the downstream spectrum for FDX devices is 108 MHz to 1218 MHz, and the downstream spectrum for FDD devices is from 258 MHz to 1794 MHz.
Downstream Channel	A portion of the electromagnetic spectrum used to convey one or more RF signals from the headend or hub site to the subscriber premises. For example, a single CEA channel's bandwidth is 6 MHz, and a downstream OFDM channel's bandwidth can be up to 192 MHz.
Downstream Full Duplex Channel	A single Full Duplex Channel assigned to be downstream for a defined period of time.
Downstream Reference Power Spectral Density	The Power Spectral Density defined at Interface D as the reference for node downstream power measurements. Downstream Reference Power Spectral Density is defined as a line on a graph with power in dB plotted on the y-axis and linear frequency plotted on the x-axis, passing through the points 37.0 dBmV in 6 MHz centered at 111 MHz and 58.0 dBmV in 6 MHz centered at 1215 MHz.
Drop	Coaxial cable and related hardware that connects a residence or other service location to a tap in the nearest coaxial feeder cable. Also called drop cable or subscriber drop.
Dynamic Host Configuration Protocol	A protocol that defines the dynamic or temporary assignment of Internet protocol addresses, so that the addresses may be reused when they are no longer needed by the devices to which they were originally assigned.
Dynamic Range Window	1) DOCSIS 3.0 - The range, in decibels, of the maximum power difference between multiple transmitters in a cable modem's Transmit Channel Set. 2) DOCSIS 3.1 - The range, in decibels, of the maximum difference in power per 1.6 MHz between multiple transmitters in a cable modem's Transmit Channel Set.
Encompassed Spectrum	1) For an OFDM or OFDMA channel, the range of frequencies from the center frequency of the channel's lowest active subcarrier minus half the subcarrier spacing, to the center frequency of the channel's highest active subcarrier plus half the subcarrier spacing. 2) For an SC-QAM channel, the encompassed spectrum is the signal bandwidth (i.e., 6 MHz or 8 MHz in the downstream; 1.6 MHz, 3.2 MHz, and 6.4 MHz in the upstream). 3) For the RF output of a downstream or upstream port including multiple OFDM, OFDMA, and/or SC-QAM channels, the range of frequencies from the lowest frequency of the encompassed spectrum of the lowest frequency channel to the highest frequency of the encompassed spectrum of the highest frequency channel.
Equalizer Tap	See <i>tap</i> .
Equivalent Legacy DOCSIS Channels	Within a downstream OFDM channel, an integer number equal to $\text{ceil}(\text{modulated spectrum in MHz} / 6)$.

EuroDOCSIS-Split	A frequency division scheme where the Upstream Upper Band Edge is 65 MHz and the Downstream Lower Band Edge is 87.5 MHz.
Excluded Subcarrier	Subcarrier that cannot be used because another type of service is using the subcarrier's frequency or a permanent ingressor is present on the frequency. The CMTS or cable modem is administratively configured to not transmit on excluded subcarriers.
Exclusion Band	A set of contiguous subcarriers within the OFDM or OFDMA channel bandwidth that are set to zero-value by the transmitter to reduce interference to other co-existing transmissions such as legacy SC-QAM signals.
F Connector	A threaded, nominally 75-ohm impedance RF connector, whose electrical and physical specifications are defined in various SCTE standards. Commonly used on smaller sizes of coaxial cable such as 59-series and 6-series, and on mating interfaces of subscriber drop components, customer premises equipment, and some headend and test equipment.
Fast Fourier Transform	An algorithm to compute the discrete Fourier transform from the time domain to the frequency domain, typically far more efficiently than methods such as correlation or solving simultaneous linear equations. See also <i>discrete Fourier transform</i> , <i>inverse discrete Fourier transform</i> , and <i>inverse fast Fourier transform</i> .
FDD Upstream Allocated Spectrum	Portion of the upstream spectrum allocated by the access network for FDD operation using TCS_FDD. It comprised of upstream FDD channels between 108 MHz and the selected upstream upper band edge, and it is further subdivided into a number of 96 MHz upstream OFDMA channels as appropriate for the selected upper band edge.
FDX-L Cable Modem	A DOCSIS 3.1 cable modem with software upgrade which can a) transmit in the 108 to 204 MHz Full Duplex upstream channels and receive in the 258 to 684 MHz Full Duplex downstream channels, in a high-split access network, or b) can receive in the 108 to 684 MHz Full Duplex downstream channels in a mid-split access network, with no access to upstream Full Duplex Channels.
FFT Duration	Reciprocal of subcarrier spacing. For example, with 50 kHz subcarrier spacing, FFT duration is 20 μ s, and with 25 kHz subcarrier spacing, FFT duration is 40 μ s. Sometimes called "useful symbol duration." See also <i>symbol duration</i> .
Fiber Node	See <i>node</i> .
Filler Subcarrier	A zero-bit-loaded subcarrier that is inserted in an OFDM symbol when no data is transmitted, or when the number of codewords has exceeded the upper limit, or when it is not possible to begin a new codeword because of insufficient space to include a next codeword pointer.
Floor	A mathematical function that returns the highest-valued integer that is less than or equal to a given value.
Forward	See downstream.
Forward Error Correction	A method of error detection and correction in which redundant information is sent with a data payload in order to allow the receiver to reconstruct the original data if an error occurs during transmission.
Frequency Division Multiple Access	A multiple access technology that accommodates multiple users by allocating each user's traffic to one or more discrete frequency bands, channels, or subcarriers.
Frequency Division Multiplexing	The transmission of multiple signals through the same medium at the same time. Each signal is on a separate frequency or assigned to its own channel. For example, an analog TV signal might be carried on CEA channel 7 (174 MHz-180 MHz), a 256-QAM digital video signal on channel 8 (180-186 MHz), and so on.
Frequency Response	A complex quantity describing the flatness of a channel or specified frequency range, and which has two components: amplitude (magnitude)-versus-frequency, and phase-versus-frequency.
Full Duplex Allocated Spectrum	The portion of the Full Duplex Band that the access network allocates for FDX operation, whether that spectrum is currently in use or not by the FDX Node receiver or any Full Duplex cable modems. Five values are defined for FDX Allocated Spectrum: 96 MHz, 192 MHz, 288 MHz, 384 MHz, and 576 MHz.
Full Duplex Band	Always 108-684 MHz. Contiguous range of RF spectrum defined in this specification and configured for Full Duplex operation. Any given access network may operate only a strict subset of the Full Duplex Band in full duplex operation. See also Full Duplex Allocated Spectrum.
Full Duplex Cable Modem	(FDX CM) A cable modem compliant to the Full Duplex specific requirements of the DOCSIS 4.0 specifications. A Full Duplex Cable Modem is capable of accessing any Full Duplex Channel whether it is used in the upstream direction or in the downstream direction.
Full Duplex Channel	A downstream OFDM channel or upstream OFDMA channel within the Full Duplex Band configured for Full Duplex operation.

Full Duplex DOCSIS	An expansion of the DOCSIS 3.1 technology defined in this specification that is targeted at significantly increasing upstream capacity by using the spectrum currently used for downstream transmission for simultaneous upstream and downstream communications via full duplex communications.
Full Duplex Dynamic Range Window	The Dynamic Range Window for upstream channels in the FDX Band, for Full Duplex cable modems operating in the FDX Mode.
Full Duplex Node	An optical node compliant to the Full Duplex specific requirements of the DOCSIS 3.1 specifications. A Full Duplex Node can access any Full Duplex Channel when it is used in the upstream direction or when it is used in the downstream direction.
Full Duplex Transition Band	The spectrum 684-804 MHz.
Full Duplex Transmit Channel Set	The set of Full Duplex Channels that an FDX Cable Modem is configured to use for upstream transmission. The Full Duplex Transmit Channel Set does not apply to DOCSIS 3.1 or FDX-L cable modems. See also Transmit Channel Set.
Gigahertz	One billion (10^9) hertz. See also <i>hertz</i> .
Group Delay	The negative derivative of phase with respect to frequency, expressed mathematically as $GD = - (d\phi/d\omega)$ and stated in units of time such as nanoseconds or microseconds.
Group Delay Ripple	Group delay variation which has a sinusoidal or scalloped sinusoidal shape across a specified frequency range.
Group Delay Variation or Group Delay Distortion	The difference in group delay between one frequency and another in a circuit, device, or system.
Guard Interval	In the time domain, the period from the end of one symbol to the beginning of the next symbol, which includes the cyclic prefix and applied transmit windowing. Also called guard time.
Guard Band	A narrow range of frequencies in which user data is not transmitted, located at the lower and upper edges of a channel, at the lower and upper edges of a gap within a channel, or in between channels. A guard band minimizes interference from adjacent signals, but is not needed in the case of adjoining OFDM channels that are synchronous with identical FFT size and cyclic prefix that would not mutually interfere.
Harmonic Related Carriers	A method of spacing channels on a cable television system defined in [CTA 542], in which visual carriers are multiples of 6.0003 MHz. A variation of HRC channelization used in some European cable networks is based upon multiples of 8 MHz.
Headend	A central facility that is used for receiving, processing, and combining broadcast, narrowcast and other signals to be carried on a cable network. Somewhat analogous to a telephone company's central office. Location from which the DOCSIS cable plant fans out to subscribers. See also <i>distribution hub</i> .
Header	Protocol control information located at the beginning of a protocol data unit.
Hertz	A unit of frequency equivalent to one cycle per second.
High-Split	A frequency division scheme where the Upstream Upper Band Edge is 204 MHz and the Downstream Lower Band Edge is 258 MHz.
Hum Modulation	Amplitude distortion of a signal caused by the modulation of that signal by components of the power source (e.g., 60 Hz) and/or its harmonics.
Hybrid Fiber/Coax	A broadband bidirectional shared-media transmission system or network architecture using optical fibers between the headend and fiber nodes, and coaxial cable distribution from the fiber nodes to the subscriber locations.
Impedance	The combined opposition to current in a component, circuit, device, or transmission line that contains both resistance and reactance. Represented by the symbol Z and expressed in ohms.
Impulse Noise	Noise that is bursty in nature, characterized by non-overlapping transient disturbances. May be periodic (e.g., automobile ignition noise or high-voltage power line corona noise), or random (e.g., switching noise or atmospheric noise from thunderstorms). It is generally of short duration - from about 1 microsecond to a few tens of microseconds - with a fast risetime and moderately fast falltime.
Incremental Related Carriers	A method of spacing channels on a cable television system defined in [CTA 542], in which all visual carriers except channels 5 and 6 are offset +12.5 kHz with respect to the standard channel plan. Channels 5 and 6 are offset +2.0125 MHz with respect to the standard channel plan. See also <i>standard frequencies</i> .
In-Phase	The real part of a vector that represents a signal, with 0 degrees phase angle relative to a reference carrier. See also <i>quadrature (Q)</i> .
Interface D	The RF output from the FDX Node, measured at the RF output port, used as a reference for Full Duplex downstream power and fidelity measurements and requirements. The downstream signal at Interface D is expected to have an up tilt.

Interface D'	The RF output from the FDX Node mathematically adjusted to convert the downstream reference PSD to a flat measurement PSD, used as a reference for Full Duplex downstream power and fidelity measurements and requirements.
Interface F	The RF output from the cable modem, measured at the RF port, used as a reference for Full Duplex upstream power and fidelity measurements and requirements. The upstream signal at Interface F is expected to have an uptilt.
Interface F'	The RF output from the cable modem mathematically adjusted to convert the upstream reference PSD to a flat measurement PSD, used as a reference for Full Duplex upstream power and fidelity measurements and requirements.
Interference Group	A group of cable modems with active channels in the Full Duplex Band that are susceptible to interfering with one another. The CMTS uses sounding to determine Interference Groups that are in turn mapped into Transmission Groups for Resource Block allocation. An Interference Group is part of a Transmission Group that non-overlapping downstream and upstream channels are allocated to avoid the upstream-to-downstream interference among cable modems in the same Interference Group.
Interleaver	A subset or layer of the forward error correction process, in which the data to be transmitted is rearranged or mixed such that the original bits, bytes, or symbols are no longer adjacent. The latter provides improved resistance to various forms of interference, especially burst or impulse noise. Interleaving may be performed in the time domain, frequency domain, or both. A de-interleaver in the receiver rearranges the bits, bytes, or symbols into their original order prior to additional error correction.
International Electrotechnical Commission	An organization that prepares and publishes international standards for electrical, electronic, and related technologies.
International Organization for Standardization	An organization that develops voluntary international standards for technology, business, manufacturing, and other industries.
Internet Engineering Task Force	A body responsible, among other things, for developing standards used on the Internet.
Internet Protocol	A network layer protocol that supports connectionless internetwork service, and which contains addressing and control information that allows packets to be routed. Widely used in the public Internet as well as private networks. The vast majority of IP devices support IP version 4 (IPv4) defined in RFC-791, although support for IP version 6 (IPv6, RFC-2460) continues to increase.
Internet Protocol Detail Record	The record formatter and exporter functions of the CMTS that provides information about Internet protocol-based service usage, and other activities that can be used by operational support systems and business support systems.
Inverse Discrete Fourier Transform	Part of the family of mathematical methods known as Fourier analysis, which defines the "decomposition" of signals into sinusoids. Inverse discrete Fourier transform defines the transformation from the frequency to the time domain. See also <i>discrete Fourier transform</i> .
Inverse Fast Fourier Transform	An algorithm to compute the inverse discrete Fourier transform from the frequency domain to the time domain, typically far more efficiently than methods such as correlation or solving simultaneous linear equations. See also <i>discrete Fourier transform</i> , <i>fast Fourier transform</i> , and <i>inverse discrete Fourier transform</i> .
Jitter	The fluctuation in the arrival time of a regularly scheduled event such as a clock edge or a packet in a stream of packets. Jitter is defined as fluctuations above 10 Hz.
Kilohertz	One thousand (10^3) hertz. See also <i>hertz</i> .
Latency	1) The time taken for a signal element to propagate through a transmission medium or device. 2) The delay between a device's request for network access and when permission is granted for transmission. 3) The delay from when a frame is received by a device to when the frame is forwarded via the device's destination port.
Layer	One of seven subdivisions of the Open System Interconnection reference model.
Legacy Transition Mode	For DOCSIS 4.0 FDD nodes, when using a Downstream Lower Band Edge below 258 MHz, the mode is operating in a mode that transmits legacy video SC-QAM and other non-DOCSIS signals below 258 MHz and is restricted to 1,536 MHz of occupied downstream spectrum.
Linear Distortion	A class of distortions that occurs when the overall response of the system (including transmitter, cable plant, and receiver) differs from the ideal or desired response. This class of distortions maintains a linear, or 1:1, signal-to-distortion relationship (Increasing signal by 1 dB causes distortion to increase by 1 dB), and often occurs when amplitude-versus-frequency and/or phase-versus-frequency depart from ideal. Linear distortions include impairments such as micro-reflections, amplitude ripple, and group delay variation, and can be corrected by an adaptive equalizer.

Low Density Parity Check	An error correction code used in DOCSIS 3.1. LDPC is more robust than Reed-Solomon error correction codes.
MAC Address	The "built-in" hardware address of a device connected to a shared medium.
MAC Frame	MAC header plus optional protocol data unit.
MAC Management Message	Unclassified traffic between the CMTS and cable modem. Examples include MAC domain descriptor, ranging-request, ranging-response, and upstream channel descriptor messages.
Media Access Control	A sublayer of the Open Systems Interconnection model's data link layer (Layer 2), which manages access to shared media such as the Open Systems Interconnection model's physical layer (Layer 1).
Megahertz	One million (10^6) hertz. See also <i>hertz</i> .
Micro-reflection	A short time delay echo or reflection caused by an impedance mismatch. A micro-reflection's time delay is typically in the range from less than a symbol period to several symbol periods.
Microsecond	One millionth (10^{-6}) of a second
Mid-Split	A frequency division scheme where the Upstream Upper Band Edge is 85 MHz and the Downstream Lower Band Edge is 108 MHz.
Millisecond	One thousandth (10^{-3}) of a second
Millivolt	One thousandth (10^{-3}) of a volt
Minimum Grant Bandwidth	The smallest grant that a CMTS is allowed to make to a CM in the TCS_FDX (see also Full Duplex Transmit Channel Set, Full Duplex Allocated Spectrum) or in the TCS_FDD (see FDD Transmit Channel Set, FDD Allocated Spectrum).
Minislot	In DOCSIS 3.0 and earlier TDMA applications, a unit of time for upstream transmission that is an integer multiple of 6.25 μ s units of time called "ticks." In DOCSIS 3.1 OFDMA applications, a group of dedicated subcarriers, all with the same modulation order, for upstream transmission by a given cable modem. For both TDMA and OFDMA, a cable modem may be assigned one or more minislots in a transmission burst.
Modulated Spectrum	1) Downstream modulated spectrum - Encompassed spectrum minus the excluded subcarriers within the encompassed spectrum, where excluded subcarriers include all the individually excluded subcarriers and all the subcarriers comprising excluded sub-bands. This also is the spectrum comprising all active subcarriers. Note: For this definition, the width of an active or excluded subcarrier is equal to the subcarrier spacing. 2) Upstream modulated spectrum - The spectrum comprising all non-zero-valued subcarriers of a cable modem's OFDMA transmission, resulting from the exercised transmit opportunities. Note: For this definition, the width of a transmitted subcarrier is equal to the subcarrier spacing.
Modulation Error Ratio	The ratio of average signal constellation power to average constellation error power - that is, digital complex baseband signal-to-noise ratio - expressed in decibels. In effect, MER is a measure of how spread out the symbol points in a constellation are. More specifically, MER is a measure of the cluster variance that exists in a transmitted or received waveform at the output of an ideal receive matched filter. MER includes the effects of all discrete spurious, noise, carrier leakage, clock lines, synthesizer products, linear and nonlinear distortions, other undesired transmitter and receiver products, ingress, and similar in-channel impairments.
Modulation Rate	The signaling rate of the upstream modulator (for example, 1280 to 5120 kHz). In S-CDMA it is the chip rate. In TDMA, it is the channel symbol rate.
Multiple Transmit Channel [Mode]	Operational mode in a cable modem that enables the simultaneous transmission of more than one upstream channel. With MTC Mode enabled, the CM and CMTS use Queue Depth Based Requesting and Continuous Concatenation and Fragmentation. DOCSIS 3.1/4.0 cable modems require MTC Mode to be enabled in Registration.
Nanosecond	One billionth (10^{-9}) of a second.
National Television System Committee	The committee that defined the analog television broadcast standards (black and white in 1941, color in 1953) used in North America and some other parts of the world. The NTSC standards are named after the committee.
Next Codeword Pointer	A message block used to identify where a codeword begins.
Node	An optical-to-electrical (RF) interface between a fiber optic cable and the coaxial cable distribution network. Also called fiber node.
Noise	Typically, any undesired signal or signals-other than discrete carriers or discrete distortion products-in a device, communications circuit, channel or other specified frequency range. See also <i>impulse noise</i> , <i>phase noise</i> , and <i>thermal noise</i> .

Nonlinear Distortion	A class of distortions caused by a combination of small signal nonlinearities in active devices and by signal compression that occurs as RF output levels reach the active device's saturation point. Nonlinear distortions generally have a nonlinear signal-to-distortion amplitude relationship-for instance, 1:2, 1:3 or worse (increasing signal level by 1 dB causes distortion to increase by 2 dB, 3 dB, or more). The most common nonlinear distortions are even order distortions such as composite second order, and odd order distortions such as composite triple beat. Passive components can generate nonlinear distortions under certain circumstances.
Occupied Bandwidth	1) Downstream - The sum of the bandwidth in all standard channel frequency allocations (e.g., 6 MHz spaced CEA channels) that are occupied by the OFDM channel. The CEA channels which are occupied by the OFDM signal are those which contain any of the Modulated Spectrum and/or taper region shaped by the OFDM channels' transmit windowing, where the values for the taper regions are defined in Appendix III as a function of the Roll-Off Period. It is possible, but not problematic, for a CEA channel to be "occupied" by two OFDM channels. 2) Upstream - a) For a single OFDMA channel, the sum of the bandwidth in all the subcarriers of that OFDMA channel which are not excluded. The upstream occupied bandwidth is calculated as the number of subcarriers which are not excluded, multiplied by the subcarrier spacing. b) For the transmit channel set, the sum of the occupied bandwidth of all OFDMA channels plus the bandwidth of the legacy channels (counted as 1.25 times the modulation rate for each legacy channel) in a cable modem's transmit channel set. The combined bandwidth of all the minislots in the channel is normally smaller than the upstream occupied bandwidth due to the existence of unused subcarriers. The bandwidth occupied by an OFDMA probe with a skip value of zero is equal to the upstream occupied bandwidth.
Orthogonal	Distinguishable from or independent such that there is no interaction or interference. In OFDM, subcarrier orthogonality is achieved by spacing the subcarriers at the reciprocal of the symbol period (T), also called symbol duration time. This spacing results in the sinc (sin x/x) frequency response curves of the subcarriers lining up so that the peak of one subcarrier's response curve falls on the first nulls of the lower and upper adjacent subcarriers' response curves. Orthogonal subcarriers each have exactly an integer number of cycles in the interval T.
Orthogonal Frequency Division Multiple Access	An OFDM-based multiple-access scheme in which different subcarriers or groups of subcarriers are assigned to different users.
OFDMA Channel Bandwidth	Occupied bandwidth of an upstream OFDMA channel. See also occupied bandwidth.
Orthogonal Frequency Division Multiplexing	A data transmission method in which a large number of closely-spaced or overlapping very-narrow-bandwidth orthogonal QAM signals are transmitted within a given channel. Each of the QAM signals, called a subcarrier, carries a small percentage of the total payload at a very low data rate.
OFDM Channel Bandwidth	Occupied bandwidth of a downstream OFDM channel. See also occupied bandwidth.
OFDMA Frame	Group of a configurable number, K, of consecutive OFDMA symbols. A frame comprises either a group of probing symbols or a column of minislots across the spectrum of the OFDMA channel. Multiple modems can share the same OFDMA frame simultaneously by transmitting data and pilots on allocated subcarriers within the frame.
Phase Noise	Rapid, short-term, random fluctuations in the phase of a wave, caused by time domain instabilities.
PHY Link Channel	A set of contiguous OFDM subcarriers (eight for 4K FFT and 16 for 8K FFT), constituting a "sub-channel" of the OFDM channel, which conveys physical layer parameters from the CMTS to cable modem.
PHY Link Channel Frame	In downstream OFDM transmission, a group of 128 consecutive OFDM symbols, beginning with the first OFDM symbol following the last OFDM symbol containing the PLC preamble.
Physical Layer	Layer 1 in the Open System Interconnection architecture; the layer that provides services to transmit bits or groups of bits over a transmission link between open systems and which entails electrical, mechanical and handshaking procedures.
Picosecond	One trillionth (10^{-12}) of a second
Pilot	A dedicated OFDM subcarrier that may be used for such purposes as channel estimation (measurement of channel condition), synchronization, and other purposes. See also <i>complementary pilots</i> , <i>continuous pilots</i> , and <i>scattered pilots</i> .
Preamble	A data sequence transmitted at or near the beginning of a frame, allowing the receiver time to achieve lock and synchronization of transmit and receive clocks.
Pre-equalizer	See adaptive pre-equalizer.
Profile	A set of parameters that defines how information is transmitted from a CMTS to a cable modem, or from a cable modem to a CMTS. Examples of some of the parameters defined in a profile include modulation order, forward error correction, preamble, and guard interval.
Protocol	A description of a set of rules and formats that specify how devices on a network exchange data.

Pseudo Random Binary Sequence	A deterministic sequence of bits that appears to be random, that is, with no apparent pattern. Also called pseudo random bitstream.
QAM Signal	Analog RF signal that uses quadrature amplitude modulation to convey information such as digital data.
Quadrature	The imaginary part of a vector that represents a signal, with 90 degrees phase angle relative to a reference carrier. See also <i>in-phase (I)</i> .
Quadrature Amplitude Modulation	A modulation technique in which an analog signal's amplitude and phase vary to convey information, such as digital data. The name "quadrature" indicates that amplitude and phase can be represented in rectangular coordinates as in-phase (I) and quadrature (Q) components of a signal.
Quadrature Phase Shift Keying	A form of digital modulation in which four phase states separated by 90 degrees support the transmission of two bits per symbol. Also called 4-QAM.
Radio Frequency	That portion of the electromagnetic spectrum from a few kilohertz to just below the frequency of infrared light.
Randomizer	A subset or layer of the forward error correction process, in which the data to be transmitted is randomized using a PRBS scrambler. Randomization spreads out the energy across the spectrum, ensures uniform population of all of the data constellation points, and minimizes the likelihood of long strings of all zeros or ones.
Receive Channel Set	The combination of legacy SC-QAM and OFDM channels that the cable modem has been configured to receive by the CMTS
Reed-Solomon	A class of error correction codes named after the inventors Irving Reed and Gustave Solomon. The forward error correction in DOCSIS 3.0 and earlier uses Reed-Solomon error correction codes.
Reported Power	When referring to a non-Full Duplex upstream transmission, the reported power per channel, $P_{1.6r_n}$, follows these conventions: 1a) For a SC-QAM channel, the reported power is expressed in terms of $P_{1.6r_n}$, i.e., the actual power for a 6.4 MHz SC-QAM channel (with 64-QAM constellation) would be 6 dB higher than the reported power (neglecting reporting accuracy); for a 1.6 MHz SC-QAM channel (with 64-QAM constellation), the actual channel power would be equal to the reported power (neglecting reporting accuracy). 1b) For SC-QAM signals with constellations other than 64-QAM, the reported power differs from the actual power due to the constellation gain as defined in [DOCSIS PHYv3.0]. 2a) For an OFDMA channel, the reported power is also expressed as $P_{1.6r_n}$, and for OFDMA channels which do not use boosted pilots, is the average RF power of the CM transmission in the OFDMA channel when transmitting in a grant comprised of 64 25 kHz subcarriers or 32 50 kHz subcarriers. 2b) For OFDMA channels which have boosted pilots and 50 kHz subcarrier spacing, reported power is 1 dB higher than the average RF power of the CM transmission with a probe comprised of 32 subcarriers. 2c) For OFDMA channels which have boosted pilots and 25 kHz subcarrier spacing, reported power is 0.5 dB higher than the average RF power of the CM transmission with a probe comprised of 64 subcarriers. For 2b and 2c, the additions to the probe power account for the maximum possible number of boosted pilots in each OFDMA symbol when the OFDMA channel uses boosted pilots.
Resource Block	A Sub-band of the Full Duplex Allocated Spectrum assigned to a Transmission Group of Full Duplex cable modems. A Resource Block have fixed configured boundaries and the capability to be dynamically assigned by the CCAP to any of a set of upstream or downstream combinations to satisfy network traffic demand and the service provider's business objectives.
Resource Block Assignment	Assignment of a Resource Block to upstream or downstream operation.
Return	See upstream.
Return Loss	The ratio of incident power P_i to reflected power P_R , expressed mathematically as $R = 10\log_{10}(P_i/P_R)$, where R is return loss in decibels.
Reverse	See upstream.
RF Channel	See channel.
Roll-off Period	Duration in microseconds, or the equivalent number of IFFT output sample periods, used for the ramping up (or ramping down) transition region of the Tukey raised-cosine window, which is applied at the beginning (and end) of an OFDM symbol. A sampling rate of 102.4 MHz is assumed for the upstream and 204.8 MHz is assumed for the downstream. The roll-off period contains an even number of samples with weighting coefficients between, but not including, 0 and 1. The rolloff, which ramps down at the end of a symbol, overlaps the mirror-image rolloff which ramps up at the beginning of the following symbol, and the two segments add to unity. In the case of no transmit windowing, the roll-off duration is zero and there are no samples in the roll-off period.
Root Mean Square	A statistical measure of the magnitude of a varying quantity such as current or voltage, where the RMS value of a set of instantaneous values over, say, one cycle of alternating current is equal to the square root of the mean value of the squares of the original values.

Scattered Pilots	Pilots that do not occur at the same frequency in every symbol, and which may be used for channel estimation. The locations of scattered pilots change from one OFDM symbol to another.
Scrambler	See randomizer.
Signal-To-Composite Noise	The ratio of signal power to composite noise power in a defined measurement bandwidth, where composite noise is the combination of thermal noise and composite intermodulation distortion (noise-like distortion).
Single Carrier Quadrature Amplitude Modulation	Data transmission method used in DOCSIS 1.x, 2.0 and 3.0, in which each downstream or upstream RF channel slot carries only one QAM signal. For the [DOCSIS PHYv3.1] specification, SC-QAM pertains to either a) DOCSIS 3.0 or earlier downstream channels, or b) TDMA, ATDMA, and S-CDMA, collectively, from DOCSIS 3.0 or earlier, for the upstream channels.
Society of Cable Telecommunications Engineers	A non-profit professional association that specializes in professional development, standards, certification, and information for the cable telecommunications industry.
Spectral Edge	For OFDM or OFDMA channel: The center frequency of the channel's lowest active subcarrier minus half the subcarrier spacing; and the center frequency of the channel's highest active subcarrier plus half the subcarrier spacing. For OFDM or OFDMA exclusion band: The center frequency of the channel's highest active subcarrier plus half the subcarrier spacing adjacent to the beginning of an exclusion band, and the center frequency of the channel's lowest active subcarrier minus half the subcarrier spacing adjacent to the end of the same exclusion band.
Standard Frequencies	Method of spacing channels on a cable television system defined in [CTA 542]. Channels 2-6 and 7-13 use the same frequencies as over-the-air channels 2-6 and 7-13. Other cable channels below Ch. 7 down to 91.25 MHz and above Ch. 13 are spaced in 6 MHz increments.
Sub-band	A fixed portion of the Full Duplex Allocated Spectrum that can be assigned to a Resource Block.
Subcarrier	One of a large number of closely spaced or overlapping orthogonal narrow-bandwidth data signals within an OFDM channel. Also called a tone. See also <i>excluded subcarrier</i> , <i>unused subcarrier</i> , and <i>used subcarrier</i> .
Subcarrier Clock Frequency	Frequency of the clock associated with the composite generation of all subcarrier signals in an OFDM/OFDMA symbol transmission, nominally 25 kHz or 50 kHz; the subcarrier clock frequency determines the subcarrier spacing (in the frequency domain).
Subcarrier Spacing	The frequency spacing between centers of adjacent subcarriers in an OFDM/OFDMA symbol, nominally equal to 25 kHz or 50 kHz.
Sublayer	A subdivision of a layer in the Open System Interconnection reference model.
Subscriber	End user or customer connected to a cable network.
Subslot	A subdivision or subunit of a minislot that fits within a minislot's boundaries, used to provide multiple transmission opportunities for bandwidth requests. Data subcarriers within a subslot use QPSK, and are not FEC encoded.
Subsplit/Extended Subsplit	A frequency division scheme where the Downstream Lower Band Edge begins between 50 MHz and 54 MHz. The Upstream Upper Band Edge could be at either 30 MHz or 42 MHz.
Symbol Duration	Sum of the FFT duration and cyclic prefix duration. Symbol duration is greater than FFT duration, because symbol duration includes a prepended cyclic prefix.
Synchronous Code Division Multiple Access	A multiple access physical layer technology in which different transmitters can share a channel simultaneously. The individual transmissions are kept distinct by assigning each transmission an orthogonal "code." Orthogonality is maintained by all transmitters being precisely synchronized with one another.
Tap	(1) In the feeder portion of a coaxial cable distribution network, a passive device that comprises a combination of a directional coupler and splitter to "tap" off some of the feeder cable RF signal for connection to the subscriber drop. So-called self-terminating taps used at feeder ends-of-line are splitters only and do not usually contain a directional coupler. Also called a multitap. (2) The part of an adaptive equalizer where some of the main signal is "tapped" off, and which includes a delay element and multiplier. The gain of the multipliers is set by the equalizer's coefficients. (3) One term of the difference equation in a finite impulse response or an infinite impulse response filter. The difference equation of a FIR follows: $y(n) = b_0x(n) + b_1x(n-1) + b_2x(n-2) + \dots + b_Nx(n-N)$.
Thermal Noise	The fluctuating voltage across a resistance due to the random motion of free charge caused by thermal agitation. Also called Johnson-Nyquist noise. When the probability distribution of the voltage is Gaussian, the noise is called additive white Gaussian noise (AWGN).
Time Division Multiple Access	A multiple access technology that enables multiple users to access, in sequence, a single RF channel by allocating unique time slots to each user of the channel.
Total Transmit Power	When referring to a non-Full Duplex cable modem upstream transmission, the cable modem total transmit power is the sum of the transmit power per channel of each channel transmitting a burst at a given time. See also Transmit Power Per Channel.

Transit Delay	The time required for a signal to propagate or travel from one point in a network to another point in the network, for example, from the CMTS to the most distant cable modem. Also called propagation delay.
Transmission Group	A logical grouping of cable modems using the Full Duplex Band, formed by the CMTS for the purpose of preventing transmissions from a cable modem from interfering with cable modems receiving in a downstream channel at the same time.
Transmit Channel Set	For an FDX cable modem, the set of non-Full Duplex channels that is assigned to use for upstream transmission (within the 5 to 85 MHz spectrum). For an FDD cable modem, the set of non-FDD channels that is assigned to use for upstream transmission (within the 5 MHz to 85 MHz spectrum or within the 5 MHz to 204 MHz only for the DOCSIS 3.1 high-split compatibility case).
Transmit Power Per Channel	When referring to a non-Full Duplex or non-FDD upstream transmission, the cable modem transmit power per channel is the average RF power in the occupied bandwidth (channel width), assuming equally likely QAM symbols, measured at the F-connector of the CM. See also Reported Power.
Transmit Pre-Equalizer	See adaptive pre-equalizer.
UHS-300	A frequency division scheme used in DOCSIS 4.0 FDD where the Upstream Upper Band Edge is set to 300 MHz. The Downstream Lower Band Edge is dependent on the capabilities of the components in the plant and may be anywhere from 300 MHz to 372 MHz.
UHS-396	A frequency division scheme used in DOCSIS 4.0 FDD where the Upstream Upper Band Edge is set to 396 MHz. The Downstream Lower Band Edge is dependent on the capabilities of the components in the plant and may be anywhere from 396 MHz to 492 MHz.
UHS-492	A frequency division scheme used in DOCSIS 4.0 FDD where the Upstream Upper Band Edge is set to 492 MHz. The Downstream Lower Band Edge is dependent on the capabilities of the components in the plant and may be anywhere from 492 MHz to 606 MHz.
UHS-684	A frequency division scheme used in DOCSIS 4.0 FDD where the Upstream Upper Band Edge is set to 684 MHz. The Downstream Lower Band Edge is dependent on the capabilities of the components in the plant and may be anywhere from 684 MHz to 834 MHz.
Under-Grant Hold Bandwidth	The minimum grant bandwidth that can be allocated beyond which the spurious emissions limits (in dBc) are no longer relaxed as the grant size continues to decrease. Defined mathematically as $UGHB = (100\% \text{ grant spectrum}) / (\text{under-grant hold number of users})$. This parameter might take on different values for the TCS and the TCS_FDX.
Under-Grant Hold Number of Users	The maximum number of equal-size grants that can be allocated beyond which the spurious emissions limits (in dBc) are no longer relaxed as the grants' size continues to increase. Defined mathematically as $UGHU = \text{floor}[0.2 + 10^{((44 - \text{SpurFloor})/10)}]$. This parameter might take on different values for the TCS and the TCS_FDX.
Unused Subcarrier	Subcarriers in an upstream OFDMA channel which are not excluded, but are not assigned to minislots. For example, unused subcarriers may occur when the number of subcarriers between excluded subcarriers is not divisible by the fixed number of consecutive subcarriers which comprise every OFDMA minislot. Thus, after constructing minislots from a group of consecutive non-excluded subcarriers, the remainder will become unused subcarriers. Unused subcarriers are not used for data transmission, but still carry power during probe transmission.
Upstream	The direction of RF signal transmission from subscriber to headend or hub site. Also called return or reverse.
Upstream Channel	A portion of the electromagnetic spectrum used to convey one or more RF signals from the subscriber premises to the headend or hub site. For example, a commonly used DOCSIS 3.0 upstream channel bandwidth is 6.4 MHz. An upstream OFDMA channel bandwidth may be as much as 95 MHz.
Upstream Channel Descriptor	The MAC management message used to communicate the characteristics of the upstream physical layer to the cable modems.
Upstream Reference Power Spectral Density	The Power Spectral Density defined at Interface F as the reference for cable modem upstream power and fidelity measurements. Upstream Reference Power Spectral Density is defined as a line on a graph with power in dB plotted on the y-axis and linear frequency plotted on the x-axis, passing through the points 33.0 dBmV in 1.6 MHz centered at 108.8 MHz and 43.0 dBmV centered at 683.2 MHz.
Used Subcarrier	An upstream subcarrier that is part of a minislot. The cable modem transmits data, ranging, and probes on these subcarriers when instructed to do so by MAP messages. MULPI term.
Useful Symbol Duration	See FFT duration.
Vector	A quantity that expresses magnitude and direction (or phase), and is represented graphically using an arrow.

Windowing	A technique to shape data in the time domain, in which a segment of the start of the IFFT output is appended to the end of the IFFT output to taper or roll-off the edges of the data using a raised cosine function. Windowing maximizes the capacity of the channel by sharpening the edges of the OFDM/A signal in the frequency domain.
Word	Information part of a codeword, without parity. See also <i>codeword</i> .
Zero-Bit-Loaded-Subcarrier	A subcarrier with power but not carrying user data, although it could be modulated by a PRBS.
Zero-Valued Minislot	A minislot composed of zero-valued subcarriers and no pilots.
Zero-Valued Subcarrier	A subcarrier with no power. See also <i>excluded subcarrier</i> .

4 ABBREVIATIONS AND ACRONYMS

This specification uses the following abbreviations and acronyms.

μs	Microsecond
ACI	Adjacent Channel Interference
ALI	Adjacent Leakage Interference
ANSI	American National Standards Institute
AWGN	Additive White Gaussian Noise
BCH	Bose, Ray-Chaudhuri, Hocquenghem (Codes)
BER	1) Bit Error Ratio; 2) Bit Error Rate
BPSK	Binary Phase Shift Keying
BW	Bandwidth
CableLabs	Cable Television Laboratories, Inc.
CCI	Co-channel Interference
CEA	Consumer Electronics Association
ceil	Ceiling
CENELEC	European Committee For Electrotechnical Standardization
CER	Codeword Error Ratio
CL	1) Convergence Layer; 2) CableLabs
CM	Cable Modem
CMCI	Cable Modem-To-Customer Premises Equipment Interface
CMTS	Cable Modem Termination System
CNR	Carrier To Noise Ratio
CP	1) Cyclic Prefix; 2) Complementary Pilot
CPD	Common Path Distortion
CPE	Customer Premises Equipment
CPU	Central Processing Unit
CRC	Cyclic Redundancy Check
CS	Cyclic Suffix
CSO	Composite Second Order
CTB	Composite Triple Beat
CW	1) Continuous Wave; 2) Codeword
CWT	Continuous Wave Tone
DAC	Digital to Analog Converter
dB	Decibel
dBc	Decibel Carrier
dBmV	Decibel Millivolt
dBr	Decibel Reference
DCA	Distributed CCAP Architecture
DCID	Downstream Channel Identifier
DEPI	Downstream External PHY Interface
DFT	Discrete Fourier Transform
DHCP	Dynamic Host Configuration Protocol
DLS	DOCSIS Light Sleep (Mode)
DOCSIS	Data-Over-Cable Service Interface Specifications
DOCSIS 1.x	Data-Over-Cable Service Interface Specifications Version 1.0 or 1.1
DOCSIS 2.0	Data-Over-Cable Service Interface Specifications Version 2.0
DOCSIS 3.0	Data-Over-Cable Service Interface Specifications Version 3.0

DOCSIS 3.1	Data-Over-Cable Service Interface Specifications Version 3.1
DRFI	DOCSIS Downstream Radio Frequency Interface Specification
DRW	Dynamic Range Window
DRW_FDD	Frequency Division Duplexing Dynamic Range Window
DRW_FDX	Full Duplex Dynamic Range Window
DS	Downstream
DSG	DOCSIS Set-Top Gateway (Interface Specification)
DTI	DOCSIS Timing Interface (Specification)
DVB	Digital Video Broadcasting (Project)
DVB-C2	"Digital Video Broadcasting (DVB); Frame Structure Channel Coding And Modulation For A Second Generation Digital Transmission System For Cable Systems (DVB-C2)"
eDOCSIS	Embedded Data-Over-Cable Service Interface Specifications
EC	Echo Cancellation or Echo Canceller
ECCP	Echo Canceller Capabilities Profile
EM	Energy Management (Message)
EMC	Electromagnetic Compatibility
EN	European Standard (<i>Européen Norme</i>)
EQAM	Edge Quadrature Amplitude Modulation (Modulator)
ERMI	Edge Resource Manager Interface (Specification)
ETSI	European Telecommunications Standards Institute
FCC	Federal Communications Commission
FDD	Frequency Division Duplexing
FDM	Frequency Division Multiplexing
FDMA	Frequency Division Multiple Access
FDX	Full Duplex or Full Duplex DOCSIS
FEC	Forward Error Correction
FFT	Fast Fourier Transform
FIR	Finite Impulse Response
FR	Fine Ranging
ft	1) Foot; 2) Feet
FTTH	Fiber To The Home
GB	(Chinese) National Standard (<i>Guobiao</i>)
GB/T	(Chinese) Recommended National Standard (<i>Guobiao Tuijian</i>)
GD	Group Delay
GDV	Group Delay Variation
GF	Galois Field
GHz	Gigahertz
GT	Guard Time
HFC	Hybrid Fiber/Coax
HRC	Harmonic Related Carriers
Hz	Hertz
I	In-Phase
ICI	Inter-Carrier Interference
I-CMTS	Integrated Cable Modem Termination System
ID	Identifier
IDFT	Inverse Discrete Fourier Transform
IEC	International Electrotechnical Commission
IETF	Internet Engineering Task Force
IFFT	Inverse Fast Fourier Transform

IG	Interference Group
IP	Internet Protocol
IPDR	Internet Protocol Detail Record
IPv4	Internet Protocol Version 4
IPv6	Internet Protocol Version 6
IR	Initial Ranging
IRC	Incremental Related Carriers
ISI	Inter-Symbol Interference
ISO	International Organization For Standardization
ITU	International Telecommunication Union
ITU-T	ITU Telecommunication Standardization Sector
kb	Kilobit
kHz	Kilohertz
L2VPN	Layer 2 Virtual Private Network
LAN	Local Area Network
LDPC	Low-Density Parity Check
LFSR	Linear Feedback Shift Register
LLR	Log-Likelihood Ratio
log	Logarithm
LSB	Least Significant Bit
LTE	Long Term Evolution
MAC	Media Access Control
MAP	Upstream Bandwidth Allocation Map
MB	Message Block
MC	Message Channel
M-CMTS	Modular Cable Modem Termination System
MER	Modulation Error Ratio
MHz	Megahertz
MMM	MAC Management Message
ms	Millisecond
MSB	Most Significant Bit
MSM	Maximum Scheduled Minislots
Msym/s	Megasymbols Per Second
MTC	Multiple Transmit Channel (Mode)
MULPI	MAC and Upper Layer Protocols Interface
mV	Millivolt
NCP	Next Codeword Pointer
NMS	Network Management System
ns	Nanosecond
NSI	Network Side Interface
NTSC	National Television System Committee
OCD	OFDM Channel Descriptor
OFDM	Orthogonal Frequency Division Multiplexing
OFDMA	Orthogonal Frequency Division Multiple Access
OOB	Out-Of-Band
OSSI	Operations Support System Interface
OU DP	OFDM Upstream Data Profile
P	Pilot
PAPR	Peak-To-Average Power Ratio

PDU	Protocol Data Unit
PER	Packet Error Ratio
PHY	Physical Layer
pk-pk	Peak-To-Peak
Pkt	Packet
PLC	PHY Link Channel
P-MAP	Probe MAP
PN	Pseudorandom Number
PRBS	Pseudo-Random Binary Sequence
Pre-eq	Pre-Equalization
ps	Picosecond
PSD	Power Spectral Density
Ptr	Pointer
Q	Quadrature
QAM	Quadrature Amplitude Modulation
QC-LDPC	Quasi-Cyclic Low-Density Parity Check
QoS	Quality Of Service
QPSK	Quadrature Phase Shift Keying
RB	Resource Block
RBA	Resource Block Assignment
RC	Raised Cosine
RCS	Receive Channel Set
REQ	Request
RF	Radio Frequency
RFC	Request For Comments
RFI	Radio Frequency Interface
RFoG	Radio Frequency Over Glass
RL	Return Loss
RMS	Root Mean Square
RP	Roll-Off Period
R-S	Reed-Solomon
RX	1) Receive; 2) Receiver
s	Second
SAC	Standardization Administration of The People's Republic of China
S-CDMA	Synchronous Code Division Multiple Access
SCN	Signal-To-Composite Noise (Ratio)
SC-QAM	Single Carrier Quadrature Amplitude Modulation
SCTE	Society of Cable Telecommunications Engineers
SEC	Security
SID	Service Identifier
SNMP	Simple Network Management Protocol
SNR	Signal-to-Noise Ratio
STD	Standard Frequencies
TCM	Trellis Coded Modulation
TCP	Total Composite Power
TCS	Transmit Channel Set
TCS_FDD	Frequency Division Duplexing Transmit Channel Set
TCS_FDX	Full Duplex Transmit Channel Set
TDM	Time Division Multiplexing

TDMA	Time Division Multiple Access
TEI	TDM Emulation Interface
TS	Time Stamp
TV	Television
TX	1) Transmit; 2) Transmitter
UCD	Upstream Channel Descriptor
UGHB	Under-Grant Hold Bandwidth
UGHU	Under-Grant Hold Number of Users
UID	Unique Identifier
URL	Uniform Resource Locator
US	Upstream
XOR	Exclusive Or
XMOD	Cross Modulation
ZBL	Zero-Bit-Loaded or Zero Bit-Loading

5 OVERVIEW AND FUNCTIONAL ASSUMPTIONS

This section describes the characteristics of a cable television plant, assumed to be for the purpose of operating a data-over-cable system.

The cable plants have very diverse physical topologies. These topologies range from fiber to the home node architectures as well as fiber nodes with many actives in cascade. The plant characteristics described in this section cover the great majority of plant scenarios.

This section is not a description of CMTS or CM parameters. The data-over-cable system MUST be interoperable within the environment described in this section.

Whenever a reference in this section to frequency plans, or compatibility with other services, conflicts with any legal requirement for the area of operation, the latter takes precedence. Any reference to National Television System Committee (NTSC) analog signals in 6 MHz channels does not imply that such signals are physically present.

5.1 Overview

This specification defines the PHY layer protocol of DOCSIS 4.0. It also describes the channel assumptions over which DOCSIS 4.0 systems are expected to operate.

DOCSIS 4.0's ultimate service goal of multi-gigabit per second in the downstream and upstream directions resulted in significant changes in the PHY layer approach compared to earlier DOCSIS versions, in addition to changes on the cable network assumptions. As with DOCSIS 3.1, DOCSIS 4.0 focuses on the eventual use of the entire spectrum resources available in the cable environment by the CMTS and CM and on scalable cost-effective techniques to achieve full spectrum use. However, DOCSIS 4.0 adds Full Duplex (FDX) DOCSIS functionality to enable flexible usage of a portion of this spectrum for simultaneous upstream and downstream transmissions. DOCSIS 4.0 also provides an extended Frequency Division Duplex (FDD) alternative to enable FDD upstream spectrum up to 684 MHz and downstream spectrum to 1794 MHz, further enhancing the efficiency and scalability of the usable spectrum according to system needs.

DOCSIS 4.0 assumes the Orthogonal Frequency Division Multiplexing (OFDM) downstream signals and Orthogonal Frequency Division Multiple Access (OFDMA) upstream signals introduced by [DOCSIS PHYv3.1] to achieve robust operation and provide more efficient use of the spectrum than previous DOCSIS versions.

The DOCSIS 3.0 systems and earlier versions are sometimes referred to in this document as single carrier QAM (SC-QAM) systems in contrast to the multicarrier OFDM/OFDMA system introduced by DOCSIS 3.1.

See also [DOCSIS PHYv3.1], section 5.1.

5.2 Functional Assumptions

5.2.1 Equipment Assumptions

5.2.1.1 Frequency Plan

In the downstream direction, the cable system is assumed to have a pass band with a lower edge of 108 MHz and upper frequency edges extending to 1218 MHz for FDX operation. For FDD operation, the following Frequency Plan applies to the downstream.

- The pass band is 1,536 MHz in width when set to a lower edge of 258 MHz and extends to 1,794 MHz.
- Cable systems with downstream lower band edges above 258 MHz extend to 1,794 MHz. Higher upper frequency edges may be considered in the specification according to future migrations of the plants.
- Cable systems with downstream lower band edges below 258 MHz are supported by the nodes to assist the operators in transitioning to DOCSIS 4.0, but the occupied downstream spectrum is limited to 1,536 MHz. FDD nodes that transmit below 258 MHz are considered to be operating in Legacy Transition Mode. Since DOCSIS 4.0 cable modems are not required to receive signals below 258 MHz, it is expected that any frequencies below 258 MHz will be restricted to video SC-QAM and other non-DOCSIS signals.

Within the downstream pass band, NTSC analog television signals in 6 MHz channels could be present on the standard HRC or IRC frequency plans of [CTA 542], as well as other narrowband and wideband digital signals.

FDX DOCSIS 4.0 specifies the continued full use of legacy upstream transmission capabilities in 5-85MHz. FDX introduces the possibility of simultaneous upstream and downstream transmissions within the 108-684MHz band. Above 684MHz FDX supports legacy downstream transmission, albeit with a transition band of reduced performance that is unspecified between 684 and 804MHz.

FDD DOCSIS 4.0 supports backwards compatibility to DOCSIS 3.1 high-split operation with full use of legacy upstream capabilities in 5 MHz to 204 MHz. As with DOCSIS 3.1 high-split, DOCSIS 4.0 supports legacy downstream transmission beginning at 258 MHz. Unlike DOCSIS 3.1, the DOCSIS 4.0 downstream upper frequency band edge can extend to 1794 MHz. DOCSIS 4.0 FDD nodes are required to support legacy plants via the downstream transmission of video SC-QAM and other non-DOCSIS signals below 258 MHz to allow operators a more gradual transition to a full FDD implementation of DOCSIS 4.0.

FDD DOCSIS 4.0 introduces Ultra-high Split (UHS) operation with the potential to add OFDMA capacity across the added upstream frequencies. UHS adds the possibility of extended splits at 300 MHz (UHS-300), 396 MHz (UHS-396), 492 MHz (UHS-492), and 684 MHz (UHS-684). Each of the new splits has a range in which the lower downstream transmission band edge can lie as defined later in this specification. As with DOCSIS 4.0 high-split, the UHS downstream upper frequency band edge can extend to 1794 MHz.

UHS operation includes continued support for DOCSIS 3.1 CMs, which can fully utilize legacy upstream transmission capabilities in 5 MHz to 204 MHz. DOCSIS 4.0 CMs can utilize legacy upstream transmission capabilities in 5 MHz to 85 MHz while also supporting OFDMA transmissions from 108 MHz to the chosen UHS extended split. For more detailed descriptions and graphical representations, refer to Section 7.3.2.5 and its subsections.

5.2.1.2 Compatibility with Other Services

The CM **MUST** coexist with any services on the cable network.

The CMTS **MUST** coexist with any services on the cable network.

In particular:

- The CMTS **MUST** be interoperable in the cable spectrum assigned for CMTS and CM interoperation while the balance of the cable spectrum is occupied by any combination of television and other signals.
- The CM **MUST** be interoperable in the cable spectrum assigned for CMTS and CM interoperation while the balance of the cable spectrum is occupied by any combination of television and other signals.
- The CMTS **MUST NOT** cause harmful interference to any other services that are assigned to the cable network in spectrum outside of that allocated to the CMTS.
- The CM **MUST NOT** cause harmful interference to any other services that are assigned to the cable network in spectrum outside of that allocated to the CM.

Harmful interference is understood as:

- No measurable degradation (highest level of compatibility),
- No degradation below the perceptible level of impairments for all services (standard or medium level of compatibility), or
- No degradation below the minimal standards accepted by the industry (for example, FCC for analog video services) or other service provider (minimal level of compatibility).

5.2.1.3 Fault Isolation Impact on Other Users

As CMTS transmissions are on a shared-media, point-to-multipoint system, fault-isolation procedures should take into account the potential harmful impact of faults and fault-isolation procedures on numerous users of the data-over-cable, video, and other services.

For the interpretation of harmful impact, see Section 5.2.1.2 above.

5.2.1.4 Cable System Terminal Devices

The CM is expected to meet and preferably exceed all applicable regulations for Cable System Termination Devices and Cable Ready Consumer Equipment as defined in FCC Part 15 [FCC15] and Part 76 [FCC76]. None of these specific requirements may be used to relax any of the specifications contained elsewhere within this document.

5.2.2 RF Channel Assumptions

The data-over-cable system, configured with at least one set of defined physical-layer parameters (e.g., modulation, interleaver depth, etc.) from the range of configurable settings described in this specification, is expected to be interoperable on cable networks having characteristics defined in this section. This is accomplished in such a manner that the forward error correction provides for equivalent operation in a cable system both with and without the impaired channel characteristics described below.

5.2.2.1 Transmission Downstream

The RF channel transmission characteristics of the cable network in the downstream direction are described in Table 3. These numbers assume total average power of a digital signal in a 192 MHz channel bandwidth for subcarrier levels unless indicated otherwise. For impairment levels, the numbers in Table 3 assume average power in a bandwidth in which the impairment levels are measured in a standard manner for cable TV systems. For analog signal levels, the numbers in Table 3 assume peak envelope power in a 6 MHz channel bandwidth. All conditions are present concurrently. It is expected that the HFC plant will have better conditions for DOCSIS 4.0 to provide the higher throughput and capacities anticipated.

Table 3 - Typical Downstream RF Channel Transmission Characteristics

Parameter	Value
Frequency range	FDX: 108 to 1218 MHz FDD: 1,536 MHz of occupied downstream spectrum in the range from 54 MHz to 1,794 MHz ¹
RF channel spacing (design bandwidth)	24 to 192 MHz
One way transit delay from headend to most distant customer	≤ 0.400 ms (typically much less)
Signal to Composite Noise Ratio	≥ 35 dB
Carrier-to-Composite triple beat distortion ratio	Not less than 41 dB
Carrier-to-Composite second order distortion ratio	Not less than 41 dB
Carrier-to-Cross-modulation ratio	Not less than 41 dB
Carrier-to-any other discrete interference (ingress)	Not less than 41 dB
Maximum amplitude variation across the 6 MHz channel (digital channels)	≤ 1.74 dB pk-pk/6 MHz
Group Delay Variation	≤113 ns over 24 MHz ²
Micro-reflections bound for dominant single echo	-20 dBc for echoes ≤ 0.5 μs -25 dBc for echoes ≤ 1.0 μs -30 dBc for echoes ≤ 1.5 μs -35 dBc for echoes > 2.0 μs -40 dBc for echoes > 3.0 μs -45 dBc for echoes > 4.5 μs -50 dBc for echoes > 5.0 μs
Carrier hum modulation	Not greater than -30 dBc (3%)
Maximum analog video carrier level at the CM input	17 dBmV
Maximum number of analog carriers	121
Table Notes:	
Note 1. Frequencies below 258 MHz are for legacy video SC-QAM and other non-DOCSIS signals to support operators in the transition to DOCSIS 4.0. DOCSIS 4.0 FDD nodes transmitting at frequencies below 258 MHz are said to be operating in Legacy Transition Mode.	
Note 2. Cascaded group delay could possibly exceed the ≤113 ns value within approximately 30 MHz above the downstream spectrum's lower band edge, depending on cascade depth, diplex filter design, and actual band split.	

5.2.2.2 Transmission Upstream

The RF channel transmission characteristics of the cable network in the upstream direction are described in Table 4. No combination of the following parameters will exceed any stated interface limit defined elsewhere in this specification. Transmission is from the CM output at the customer location to the headend.

Table 4 - Typical Upstream RF Channel Transmission Characteristics

Parameter	Value
Frequency range	FDX: 5 to 85 MHz and 108 to 684 MHz FDD high-split backward compatibility: 5 MHz to 204 MHz FDD UHS (DOCSIS 3.1 CMs): 5 MHz to 204 MHz FDD UHS (DOCSIS 4.0 CMs): 5 to 85 and 108 to xxx MHz (where xxx = 300, 396, 492, or 684 MHz)
One way transit delay from most distant customer to headend.	≤ 0.400 ms (typically much less)
Carrier-to-interference plus ingress (the sum of noise, distortion, common-path distortion and cross modulation and the sum of discrete and broadband ingress signals, impulse noise excluded) ratio	Not less than 25 dB
Carrier hum modulation	Not greater than -26 dBc (5.0%)
Maximum amplitude variation across the 6 MHz channel (digital channels)	≤ 2.78 dB pk-pk/6 MHz
Group Delay Variation	≤163 ns over 24 MHz
Micro-reflections bound for dominant single echo	-16 dBc for echoes ≤ 0.5 μs -22 dBc for echoes ≤ 1.0 μs -29 dBc for echoes ≤ 1.5 μs -35 dBc for echoes > 2.0 μs -42 dBc for echoes > 3.0 μs -51 dBc for echoes > 4.5 μs
Seasonal and diurnal reverse gain (loss) variation	Not greater than 14 dB min to max
NOTE: Cascaded group delay could possibly exceed the ≤163 ns value within approximately 10 MHz of the upstream spectrum's lower and upper band edges, depending on cascade depth, diplex filter design, and actual band split.	

5.2.2.2.1 Availability

Cable network availability is typically greater than 99.9%.

5.2.3 Transmission Levels

The nominal power level of the upstream CM signal(s) will be as low as possible to achieve the required margin above noise and interference. Uniform power loading per unit bandwidth is commonly followed in setting upstream signal levels, with specific levels established by the cable network operator to achieve the required carrier-to-noise and carrier-to-interference ratios.

5.2.4 Frequency Inversion

There will be no frequency inversion in the transmission path in either the downstream or the upstream directions, i.e., a positive change in frequency at the input to the cable network will result in a positive change in frequency at the output.

6 PHY SUBLAYER FOR SC-QAM

6.1 Scope

This section applies to cases where a DOCSIS 4.0 CM or CMTS is operating with simultaneous operation of SC-QAM and OFDM/OFDMA channels unless otherwise noted. Throughout this entire document, "OFDM" pertains to downstream, "OFDMA" pertains to upstream, and "SC-QAM" pertains to either a) DOCSIS 3.0 or earlier downstream channels, or b) TDMA, ATDMA, collectively, from DOCSIS 3.0 or earlier, for the upstream channels. The S-CDMA support is not required for the DOCSIS 4.0 CM and CMTS.

This specification defines the electrical characteristics and signal processing operations for a CM and CMTS. It is the intent of this specification to define an interoperable DOCSIS 4.0 CM and CMTS such that any implementation of a DOCSIS 4.0 CM can work with any DOCSIS 4.0 or DOCSIS 3.1 CMTS. It is not the intent of this specification to imply any specific implementation.

As the requirements for a DOCSIS 4.0 CM and CMTS are largely unchanged relative to SC-QAM operation, this section is composed primarily of references to the appropriate DOCSIS 3.0 specification sections for the specific requirements for a DOCSIS 4.0 CM and CMTS, as well as any deltas relative to those requirements.

A DOCSIS 4.0 CM MUST comply with the referenced requirements in the [DOCSIS PHYv3.0] and [DOCSIS DRFI] specifications noted in this section, with the exception of any deltas called out in this section (which will be identified with separate requirement statements). A DOCSIS 4.0 CMTS MUST comply with the referenced requirements in the [DOCSIS PHYv3.0] and [DOCSIS DRFI] specifications noted in this section, with the exception of any deltas called out in this section (which will be identified with separate requirement statements).

6.2 Upstream Transmit and Receive

This section is based on section 6.2 of [DOCSIS PHYv3.0].

6.2.1 Overview

See section 6.2.1 of [DOCSIS PHYv3.0], with the exceptions noted in Section 7.2 for the FDX CM and Section 7.3 for the FDD CM.

6.2.2 Signal Processing Requirements

See section 6.2.2 of [DOCSIS PHYv3.0].

6.2.3 Modulation Formats

See section 6.2.3 of [DOCSIS PHYv3.0].

6.2.4 R-S Encode

See section 6.2.4 of [DOCSIS PHYv3.0].

6.2.5 Upstream R-S Frame Structure (Multiple Transmit Channel Mode Enabled)

See section 6.2.5 of [DOCSIS PHYv3.0].

6.2.6 Upstream R-S Frame Structure (Multiple Transmit Channel Mode Disabled)

See section 6.2.6 of [DOCSIS PHYv3.0].

6.2.7 TDMA Byte Interleaver

See section 6.2.7 of [DOCSIS PHYv3.0].

6.2.8 Scrambler (randomizer)

See section 6.2.8 of [DOCSIS PHYv3.0].

6.2.9 TCM Encoder

See section 6.2.9 of [DOCSIS PHYv3.0].

6.2.10 Preamble Prepend

See section 6.2.10 of [DOCSIS PHYv3.0].

6.2.11 Modulation Rates

See section 6.2.11 of [DOCSIS PHYv3.0].

6.2.12 S-CDMA Framer and Interleaver

See section 6.2.12 of [DOCSIS PHYv3.0].

6.2.13 S-CDMA Framer

See section 6.2.13 of [DOCSIS PHYv3.0].

6.2.14 Symbol Mapping

See section 6.2.14 of [DOCSIS PHYv3.0].

6.2.15 S-CDMA Spreader

See section 6.2.15 of [DOCSIS PHYv3.0].

6.2.16 Transmit Pre-Equalizer

See section 6.2.16 of [DOCSIS PHYv3.0].

6.2.17 Spectral Shaping

See section 6.2.17 of [DOCSIS PHYv3.0].

6.2.18 Relative Processing Delays

See section 6.2.18 of [DOCSIS PHYv3.0].

6.2.19 Transmit Power Requirements

For the case in which a DOCSIS 4.0 CM is operating with a DOCSIS 3.0 CMTS regardless of channel type, the transmit power requirements are described in Section 7.2.4.12.4 for the FDX CM and in Section 7.3.4.12.4 for the FDD CM. The requirements in Section 7.2.4.12.4 or 7.3.4.12.4 apply even when all upstream channels on the DOCSIS 4.0 CM are SC-QAM.

6.2.20 Burst Profiles

See section 6.2.20 of [DOCSIS PHYv3.0].

6.2.21 Burst Timing Convention

See section 6.2.21 of [DOCSIS PHYv3.0].

6.2.22 Fidelity Requirements

For the case in which a DOCSIS 4.0 CM is operating with a DOCSIS 4.0 CMTS regardless of channel type, the fidelity requirements are described in Section 7.2.4.12.7 for FDX CMs and Section 7.3.4.12.7 for FDD CM. The requirements in Sections 7.2.4.12.7 and 7.3.4.12.7 apply even when all upstream channels on the DOCSIS 3.1 CM are SC-QAM. For this case there are no MER requirements for SC-QAM channels. So the Sections 7.2.4.12.7.2 and 7.3.4.12.7.2 do not apply for this case.

6.2.23 Upstream Demodulator Input Power Characteristics

See section 6.2.23 of [DOCSIS PHYv3.0].

6.2.24 Upstream Electrical Output from the CM

For the case in which a DOCSIS 4.0 CM is operating with a DOCSIS 3.1 CMTS regardless of channel type, the upstream electrical output requirements are described in Section 7.2.4.13 (FDX CM) and 7.3.4.13 (FDD CM). The requirements in these sections apply even when all upstream channels on the DOCSIS 4.0 CM are SC-QAM.

Table 5 - CM Transmitter Output Signal Characteristics for SC-QAM channels

Parameter	Value
Frequency	Support and be configurable to a permitted subset (see Section 7.2.2.3 for allowed combinations) of the following frequency range: 5 MHz to 85 MHz NOT to cause harmful interference above these frequencies for any configured option.
Signal Type	TDMA
Modulation Type	QPSK, 8-QAM, 16-QAM, 32-QAM, and 64-QAM
Modulation Rate (nominal)	TDMA: 1280, 2560, and 5120 kHz Optional pre-3.0-DOCSIS operation, TDMA: 160, 320, and 640 kHz
Bandwidth	TDMA: 1600, 3200, and 6400 kHz Optional pre-3.0-DOCSIS operation, TDMA: 200, 400, and 800 kHz
Level	Total average output power of 65 dBmV. (See item # 1 immediately following this table) Total average output power greater than 65 dBmV. (See item # 2 following this table)
Output Impedance	75 ohms
Output Return Loss	> 6 dB 5 MHz to 85 MHz
Connector	F connector per [ISO/IEC-61169-24] or [SCTE 02]

The following is an itemized list of CM Transmitter Output Signal Characteristics based on Table 5 above.

1. The DOCSIS 4.0 CM MUST be capable of transmitting a total average output power of 65 dBmV when operating in DOCSIS 3.1 mode.
2. The DOCSIS 4.0 CM MAY be capable of transmitting a total average output power greater than 65 dBmV when operating in DOCSIS 3.1 mode.

6.2.25 Upstream CM Transmitter Capabilities

For the case in which a DOCSIS 4.0 CM is operating with a DOCSIS 3.0 CMTS or where a DOCSIS 4.0 CMTS is operating with a DOCSIS 3.0 CM; see section 6.2.25 of [DOCSIS PHYv3.0].

For the case in which a DOCSIS 4.0 CM is operating with a DOCSIS 4.0 CMTS regardless of channel type, the transmitter capabilities are described in [DOCSIS PHYv3.1].

6.3 Downstream Transmit

This section is based on section 6.3 of [DOCSIS DRFI].

6.3.1 Downstream Protocol

See section 6.3.1 of [DOCSIS DRFI].

6.3.2 Spectrum Format

See section 6.3.2 of [DOCSIS DRFI].

6.3.3 Scalable Interleaving to Support Video and High-Speed Data Services

See section 6.3.3 of [DOCSIS DRFI].

6.3.4 Downstream Frequency Plan

See section 6.3.4 of [DOCSIS DRFI].

6.3.5 DRFI Output Electrical

Applies only the case where a DOCSIS 4.0 device is operating in DOCSIS 3.0 mode only.

For legacy SC-QAMs, the EQAM and CMTS MUST support the electrical output requirements specified in the following sections and tables of [DOCSIS DRFI]:

- Section 6.3.5, DRFI Output Electrical
- Section 6.3.5.1, CMTS or EQAM Output Electrical
- Table titled: RF Output Electrical Requirements, in Section 6
- Section 6.3.5.1.1, Power per Channel CMTS or EQAM
- Table titled: DRFI Device Output Power, in Section 6
- Section 6.3.5.1.2, Independence of Individual Channels within the Multiple Channels on a Single RF Port
- Section 6.3.5.1.3, Out-of-Band Noise and Spurious Requirements for CMTS or EQAM
- Table titled: EQAM or CMTS Output Out-of-Band Noise and Spurious Emissions Requirements for $N \leq 8$, in Section 6
- Table titled: EQAM or CMTS Output Out-of-Band Noise and Spurious Emissions Requirements $N \geq 9$ and $N' \geq N/4$, in Section 6
- Table titled: EQAM or CMTS Output Out-of-Band Noise and Spurious Emissions Requirements $N \geq 9$ and $N' < N/4$, in Section 6

6.3.6 CMTS or EQAM Clock Generation

Applies only to the case where a DOCSIS 4.0 CMTS is operating in a DOCSIS 3.0 mode only.

See section 6.3.6 of [DOCSIS DRFI].

6.3.7 Downstream Symbol Clock Jitter for Synchronous Operation

Applies only to the case where a DOCSIS 4.0 CMTS is operating in a DOCSIS 3.0 mode only.

See section 6.3.7 of [DOCSIS DRFI].

6.3.8 Downstream Symbol Clock Drift for Synchronous Operation

Applies only to the case where a DOCSIS 4.0 CMTS is operating in a DOCSIS 3.0 mode only.

See section 6.3.8 of [DOCSIS DRFI].

6.3.9 Timestamp Jitter

See section 6.3.9 of [DOCSIS DRFI].

6.4 Downstream Receive

This section is based on section 6.3 of [DOCSIS PHYv3.0].

6.4.1 Downstream Protocol and Interleaving Support

See section 6.3.1 of [DOCSIS PHYv3.0].

6.4.2 Downstream Electrical Input to the CM

See section 6.3.2 of [DOCSIS PHYv3.0], with the exception noted below.

A CM MUST support at least 32 active downstream SC-QAM channels.

A CMTS MUST support at least 32 active downstream SC-QAM channels.

6.4.3 CM BER Performance

See section 6.3.3 of [DOCSIS PHYv3.0].

6.4.3.1 FDX CM BER Performance Above the FDX Transition Band

The CM BER performance of an FDX CM operating in FDX mode receiving SC-QAM channels between 804 MHz and 1002 MHz with a flat receive PSD in the presence of AWGN is given in sections 6.3.3.1.1 and 6.3.3.2.1 of [DOCSIS PHYv3.0].

Implementation loss of the FDX CM when in FDX mode MUST be such that the CM achieves a post-FEC BER less than or equal to 10^{-8} when operating at a carrier to noise ratio (E_s/N_0) as shown in Table 6 - Minimum CNR Performance 804 MHz to 1002 MHz for FDX CM Operating in FDX Mode. If it is not possible to measure post-FEC BER directly, Codeword Error Ratio, R_C (as defined in section 6.3.3.1.1 of [DOCSIS PHYv3.0]) may be used. In this case, the FDX CM MUST achieve a Codeword Error Ratio of less than or equal to 9×10^{-7} when operating at a carrier to noise ratio (E_s/N_0), as shown in Table 6 - Minimum CNR Performance 804 MHz to 1002 MHz for FDX CM Operating in FDX Mode below.

Table 6 - Minimum CNR Performance 804 MHz to 1002 MHz for FDX CM Operating in FDX Mode

SC-QAM Modulation Order	Receive Signal Level (dBmV/6MHz)	Minimum CNR (dB)
256	-6 to +15	30
256	-15 to <-6	33
64	-15 to +15	23.5

For an FDX CM not operating in FDX mode, the requirements in [DOCSIS PHYv3.0] apply for downstream SC-QAM performance.

6.4.4 Downstream Multiple Receiver Capabilities

See section 6.3.4 of [DOCSIS PHYv3.0].

6.4.5 Non-Synchronous DS Channel Support

Applies only to the case where a DOCSIS 4.0 CM operating with a DOCSIS 3.0 CMTS.

See section 6.3.5 of [DOCSIS PHYv3.0].

7 PHY SUBLAYER FOR OFDM

7.1 Scope

This specification defines the electrical characteristics and signal processing operations for a cable modem (CM) and Cable Modem Termination System (CMTS). It is the intent of this specification to define an interoperable CM and CMTS such that any implementation of a CM can work with any CMTS. It is not the intent of this specification to imply any specific implementation.

This section describes CM and CMTS physical layer requirements for DOCSIS 4.0-compliant devices in either Full-Duplex DOCSIS (FDX) or Frequency Division Duplexed (FDD) environments.

DOCSIS 4.0 FDX is an expansion of the DOCSIS 3.1 specification that is targeted at significantly increasing upstream capacity by using the spectrum currently used for downstream transmission for simultaneous upstream and downstream communications via full duplex communications. Therefore, many sections refer to basic OFDM sublayer definitions described in the [DOCSIS PHYv3.1] specification.

DOCSIS 4.0 FDD is an expansion of the DOCSIS 3.1 specification that is targeted at significantly increasing upstream and downstream capacity by extending the available upstream dedicated spectrum beyond previously defined upper bounds to as much as 684 MHz and also extending the available downstream spectrum capabilities to 1794 MHz, while maintaining spectrum separation between upstream and downstream transmissions at a predefined frequency.

The following sections are intended to treat separately the PHY OFDM sublayer requirements for FDX or FDD capability requirements. Section 7.2 and its subsections address the PHY sublayer requirements specific to DOCSIS 4.0 FDX functionality. Section 7.3 and its subsections address the PHY sublayer requirements specific to DOCSIS 4.0 FDD functionality.

7.2 PHY Sublayer for FDX OFDM

Full Duplex capability requires additional functions to be added to the DOCSIS 3.1 requirements. These new functions are specified in this specification. As with previous generations of DOCSIS technologies, DOCSIS 4.0-compliant devices will be backward-compatible with previous generations of DOCSIS technology. The FDX Allocated Spectrum is subdivided into FDX channels that can be assigned to modems according to system requirements. FDX channels carry both upstream and downstream traffic. The CMTS assignment of FDX channels within the FDX band for Full Duplex DOCSIS operation can be done incrementally over time as a transition strategy, from existing DOCSIS networks to Full Duplex DOCSIS networks, as FDX-capable CMTSs and modems become available.

For an FDX DOCSIS system, a distributed architecture is assumed due to the echo cancellation functionality that is required. Thus, this portion of the specification refers to the physical layer functionality of an FDX-capable CMTS as the FDX Node. The CMTS is occasionally used to refer to the total functionality across the MAC layer and the Physical layer.

An FDX-compliant FDX Node supports simultaneous upstream and downstream communications over each FDX channel; this is enabled by cancellation techniques for self-interference and echo cancellation. FDX-compliant cable modems will operate in frequency division duplexing mode, where on any FDX channel, the CM is either transmitting in the upstream or receiving in the downstream. An FDX-compliant CMTS allocates FDX channels to cable modems by providing modems access to upstream and downstream channels through FDD; a CM's operation on an FDX channel in either US or DS can be changed by the CMTS. FDX channels can be bonded with non-FDX channels and with other FDX channels.

To avoid the risk of co-channel interference (CCI) and adjacent channel interference (ACI) between CMs, the CMTS schedules transmissions and grants such that a CM does not transmit at the same time as other CMs that are susceptible to interference from the transmitting CM are receiving. CM to CM interference susceptibility is measured through a sounding process that is defined in the specification. After measuring CM to CM interference susceptibility, the CMTS creates groups of CMs that are susceptible to interfering with one another, called

Interference Groups (IG), and schedules transmissions and grants to CMs to avoid having a CM transmit when other CMs in its IG are receiving.

A DOCSIS 4.0-compliant CM supports two modes of operation related to FDX:

1. DOCSIS 3.1 mode: The FDX CM behaves identically to a DOCSIS 3.1-compliant cable modem and adheres to the requirements in section 7 of [DOCSIS PHYv3.1]. An FDX CM is in this mode if it is on a non-FDX plant or it is on an FDX plant but configured to operate in DOCSIS 3.1 mode.
2. FDX mode: An FDX CM is in this mode when it is on an FDX plant and is configured for FDX operation. In this mode the CM adheres to the requirements in this specification. This includes when in both non-FDX and FDX operational states.

Transitioning between modes 1 and 2 requires a CM reboot.

7.2.1 Full Duplex Node Reference Interfaces

In comparison to reference interfaces defined in annex D of [DOCSIS DRFI], FDX Node defines two additional interfaces, E and F, that compensate for upstream and downstream power tilt. These interfaces are indicated in Figure 4 below.

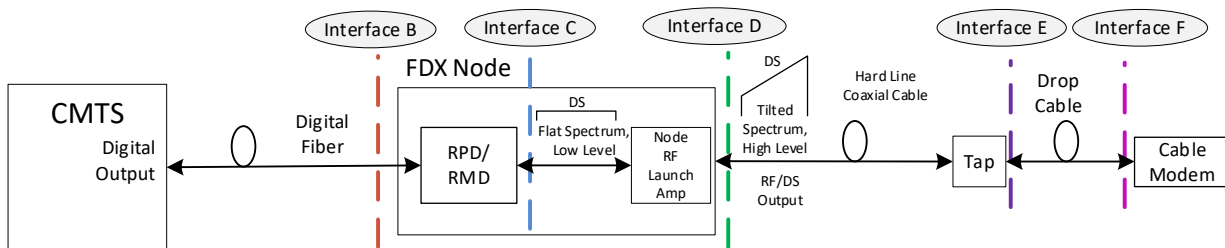

Figure 4 - Full Duplex Node Reference Interfaces

7.2.2 Upstream and Downstream Frequency Plan

For DOCSIS 4.0 devices operating in FDX mode, this section augments section 7.2 of [DOCSIS PHYv3.1] and corresponding subsections unless otherwise noted.

For DOCSIS CMTSs that implement FDX DOCSIS capability and FDX CMs, the legacy DOCSIS requirement for downstream transmission frequencies to always reside above the upstream transmission frequencies in the cable plant no longer applies.

If a CMTS implements FDX DOCSIS capability, the CMTS MUST support US reception and DS transmission on channels occupying the same FDX spectrum yielding concurrent US and DS transmissions at the MAC level.

The FDX CM MAY support US transmission and DS reception on channels occupying the same FDX spectrum yielding concurrent US and DS transmissions at the MAC and PHY level.

The channel resources for FDX devices are summarized in Table 7; the requirements are described in the following subsections.

The frequency range defined for FDX DOCSIS is 108 MHz to 684 MHz. The upper limit of 684 MHz is derived from starting with the lower band edge of mid-split (108 MHz) and allowing for three OFDM channels at 192 MHz each.

The FDX OFDM channels operate on a predefined grid as described in Section 7.2.2.5.5.

Table 7 - Channel Resources for FDX Devices

Item	Device	OFDM/OFDMA	SC-QAM
Downstream Channel Support	CM	5 total OFDM channels; 3 channels capable of FDX operation; All channels capable of non-FDX operation up to 1218 MHz	32
	CMTS	6 total OFDM channels; 3 channels capable of FDX operation; All channels capable of non-FDX operation up to 1218 MHz	32
Upstream Channel Support	CM	At least 7 total OFDMA channels; 6 channels capable of FDX operation; 2 channels capable of non-FDX operation within the legacy diplexer configuration. (Some channels can be configurable to support either FDX or non-FDX operation. When supporting 6 FDX OFDMA channels, only 1 non-FDX OFDMA channel is required.)	4 (or 8) SC-QAM channels, operating within the legacy diplexer configuration
	CMTS	8 total OFDMA channels; 6 channels with FDX operation; 2 channels capable of non-FDX operation based on operator deployment requirements.	4 (or 8) SC-QAM channels, operation dependent on operator deployment requirements

7.2.2.1 Downstream FDX CM Spectrum

The CM complies with the following requirements, which are additional to the requirements of [DOCSIS PHYv3.1], section 7.2.1:

- The FDX CM's demodulator MUST support receiving downstream full duplex channels from 108 MHz to 684 MHz.
- The FDX CM MUST be capable of receiving 5 total OFDM channels, both FDX and non-FDX combined. The FDX CM MUST support FDX operation at either 96 MHz width or 192 MHz width on three of the OFDM channels in the FDX spectrum (refer to Figure 5). When not operating on an FDX system, 2 of these OFDM channels MUST be capable of legacy (non-FDX) operation at a width up to 192 MHz.

7.2.2.2 Downstream FDX CMTS Spectrum

The Node complies with the following requirements, in addition to the requirements of [DOCSIS PHYv3.1], section 7.2.2:

- The FDX Node modulator MUST support downstream full duplex channel transmissions from 108 MHz to 684 MHz.
- The FDX Node MUST support a minimum of 6 independently configurable OFDM channels, each occupying a spectrum of up to 192 MHz in the downstream, bounded by the lower band edge and the upper band edge of the DS spectrum. The FDX Node MUST support 3 independently configurable OFDM channels, each occupying a spectrum of either 96 MHz or 192 MHz in the FDX spectrum.

7.2.2.3 Upstream FDX CM Spectrum

The CM complies with the following requirements:

- The FDX CM modulator MUST support upstream transmissions from 5 MHz to 85 MHz and from 108 MHz to 684 MHz. Upstream transmission between 85 MHz and 108 MHz is not required.
- The FDX CM MUST support a minimum of 7 independently configurable OFDMA upstream channels, each occupying a spectrum of up to 96 MHz. This applies to all OFDMA channels supported by the FDX CM, not just FDX OFDMA channels.
- The FDX CM MUST be capable of supporting FDX upstream operation on 6 of the upstream OFDMA channels.

- The FDX CM MUST be capable of transmitting on all upstream channels simultaneously.
- The FDX CM MUST support a minimum of 4 upstream SC-QAM channels in 5 MHz to 85 MHz. The FDX CM SHOULD support a minimum of 8 upstream SC-QAM channels. This is the total number of SC-QAM channels, and not additional channels with respect to a DOCSIS 3.1 CM.
- The FDX CM MUST be capable of supporting non-FDX upstream operation on 1 of the upstream OFDMA channels in the range 5 MHz to 85 MHz when operating on an FDX plant.
- The FDX CM MUST be capable of supporting upstream operation on 2 of the upstream OFDMA channels when operating on a legacy (non-FDX) plant. The FDX CM MUST support operation on these non-FDX channels from 5 MHz to either 85MHz or 204 MHz, depending on the legacy diplexer configuration.

7.2.2.4 Upstream FDX Node Spectrum

If a CMTS implements Full Duplex DOCSIS capability, the Node complies with the following requirements, in addition to the requirements of [DOCSIS PHYv3.1], section 7.2.4:

- If an FDX CMTS implements Full Duplex DOCSIS capability, the FDX Node demodulator MUST be capable of receiving upstream transmissions from 5 MHz to 85 MHz and from 108 MHz to 684 MHz. Upstream reception between 85 MHz and 108MHz is not required.
- If an FDX CMTS implements Full Duplex DOCSIS capability, the FDX Node MUST support 8 configurable OFDMA upstream channels, each occupying a spectrum of up to 95 MHz. This applies to all OFDMA channels supported by the CMTS, not just FDX OFDMA channels.

7.2.2.5 FDX Channel Band Rules

7.2.2.5.1 Downstream Channel Bandwidth Rules

See [DOCSIS PHYv3.1], section 7.2.5.1.

7.2.2.5.2 Downstream Exclusion Band Rules

See [DOCSIS PHYv3.1], section 7.2.5.2.

7.2.2.5.3 Upstream Channel Bandwidth Rules

See [DOCSIS PHYv3.1], section 7.2.5.3.

7.2.2.5.4 Upstream Exclusions and Unused Subcarriers Rules

See [DOCSIS PHYv3.1], section 7.2.5.4.

7.2.2.5.5 Full Duplex Channel Band Rules

The Full Duplex Band is defined as extending from 108 MHz to 684 MHz regardless of whether FDX channels occupy the whole band.

The FDX Allocated Spectrum is defined as the same as the occupied spectrum, which is all the spectrum in an access network allocated to Full Duplex operation, including guard bands, whether it is used for Full Duplex or not.

The FDX CMTS MUST ensure that first and last active subcarriers of the OFDMA channels in a sub-band do not extend beyond the first and last active subcarriers of a single DS OFDM channel in the same sub-band.

The FDX CMTS MUST ensure that any excluded subcarrier in the downstream channel is excluded in the upstream channel.

The FDX Node MUST configure the FDX Allocated Spectrum to start at 108 MHz.

The FDX Node MUST support the configuration of the following bandwidths for the FDX Allocated Spectrum and the sub-band options:

- 96 MHz: Occupying 108 MHz to 204 MHz.
Supporting 1 sub-band; composed of a 96 MHz FDX US channel and a 96 MHz FDX DS channel.
- 192 MHz: Occupying 108 MHz to 300 MHz.
Supporting 2 sub-bands. Each sub-band is configured to be 96 MHz wide, composed of 1 FDX US channel and 1 FDX DS channel.
- 288 MHz: Occupying 108 MHz to 396 MHz.
Supporting 3 sub-bands. Each sub-band is configured to be 96 MHz wide, composed of 1 FDX US channel and 1 FDX DS channel.
- 384 MHz: Occupying 108 MHz to 492 MHz.
Supporting 2 sub-bands. Each sub-band is configured to be 192 MHz wide, composed of 2 FDX US channels and 1 FDX DS channel.
- 576 MHz: Occupying 108 MHz to 684 MHz.
Supporting 3 sub-bands. Each sub-band is configured to be 192 MHz wide, composed of 2 FDX US channels (96 MHz wide each) and 1 FDX DS channel.

The configurable allocated spectrum bandwidths described above are illustrated in Figure 5 below.

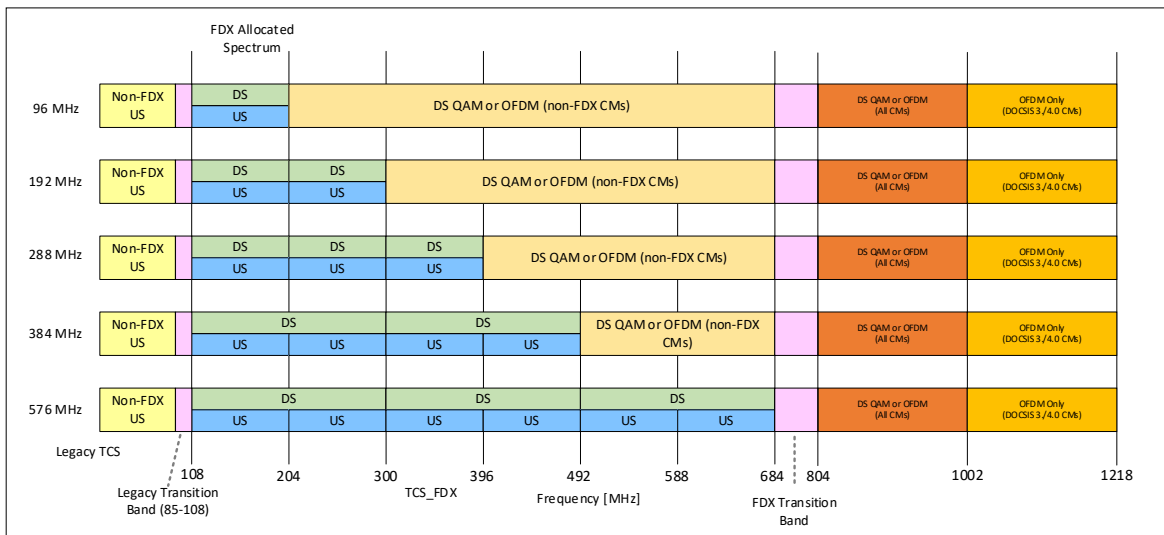

Figure 5 - Configurable FDX Allocated Spectrum Bandwidths

An FDX CMTS MUST configure the downstream channel and upstream channels sharing the same sub-band to the same subcarrier spacing and cyclic prefix length. The subcarrier spacing and cyclic prefix on different sub-bands are allowed to be different.

An FDX CMTS MUST configure the FDX Allocated Spectrum to contain only DS and US FDX channels.

7.2.2.5.5.1 FDX CM and FDX-L CM Operation in a High-Split Network

A high-split network is defined as an HFC network where legacy DOCSIS technologies exist, and the upstream band extends from 5 MHz to 204 MHz. Given that the FDX Allocated Spectrum always starts at 108 MHz, then the operation of an FDX DOCSIS system in a high-split network will entail some overlap between the legacy upstream band and the FDX Allocated Spectrum.

In such a situation, certain precautions need to be taken into consideration to make sure that the upstream bursts in the 108 MHz to 204 MHz band from DOCSIS devices (FDX-L cable modems) do not interfere with the downstream FDX channel operating in the same band. This is accomplished by having the FDX-L cable modems participate in the channel sounding procedure as described in Section 7.2.6.

In the above described scenario, the upstream band for FDX-L cable modems extends from 5 MHz to 204 MHz.

For an FDX CM operating in a 5 MHz to 204 MHz Network, the legacy upstream channels for the FDX CM operate in the 5 MHz to 85 MHz band. The 85 MHz to 108 MHz band is a transition region that is not used by the FDX CM to transmit or receive DOCSIS signals. Upstream FDX Channels operate in the FDX Allocated Spectrum starting at 108 MHz.

7.2.2.6 Operation in the FDX Band in Non-Allocated Spectrum

Non-allocated spectrum is the spectrum within the FDX band between the highest frequency of the FDX allocated spectrum and 684 MHz.

An FDX Node MUST be able to place either SC-QAM or non-FDX OFDM channels in the non-allocated spectrum of the FDX band with RF performance requirements specified in this section.

An FDX CM in FDX mode is not required to receive either SC-QAM or non-FDX OFDM channels in the non-allocated spectrum of the FDX band.

There are no US channels in the non-allocated spectrum of the FDX band.

7.2.2.7 Operation in the FDX Transition Band

The FDX transition band is the spectrum between 684 MHz and 804 MHz.

An FDX Node MUST be able to place either SC-QAM or non-FDX OFDM channels in the FDX transition band with RF performance requirements specified in this section.

An FDX CM in FDX mode SHOULD be able to receive either SC-QAM or non-FDX OFDM channels in this band. It is possible that performance in this band could be impaired compared to a compliant DOCSIS 3.1 CM. As such, performance in the FDX transition band for an FDX CM operating in FDX mode is not specified.

7.2.2.8 Operation Above the FDX Transition Band

An FDX Node MUST be able to place either SC-QAM or non-FDX OFDM channels in the spectrum above 804 MHz with RF performance requirements specified in this section.

An FDX CM operating in FDX mode MUST be able to receive either SC-QAM or non-FDX OFDM channels above 804 MHz. FDX CM CNR and minimum PSD performance above the FDX transition band testing are defined in Section 7.2.5.12.5.

7.2.3 FDX OFDM Numerology

See [DOCSIS PHYv3.1], section 7.3.

7.2.4 Upstream Transmit and Receive

7.2.4.1 Signal Processing Requirements

See [DOCSIS PHYv3.1], section 7.4.1.

7.2.4.2 Time and Frequency Synchronization

See [DOCSIS PHYv3.1], section 7.4.2.

7.2.4.2.1 Channel Frequency Accuracy

This section augments section 7.4.2.1 of [DOCSIS PHYv3.1].

The frequency of the upstream subcarrier clock (or upstream subcarrier spacing) is required to be accurate within 0.4 ppm and each subcarrier frequency accurate within 30 Hz, both relative to the Master Clock reference, and both for five sigma of the upstream OFDMA transmissions, for subcarrier frequencies up to 684 MHz. The measurements of the frequency of the upstream subcarrier clock, and the subcarrier frequencies, are averaged over the duration of an upstream single-frame grant. A constant temperature is maintained during the measurements within a range of $20\text{ }^{\circ}\text{C} \pm 2\text{ }^{\circ}\text{C}$. A minimum warm-up time of 30 minutes occurs before the CM frequency measurements are made.

7.2.4.2.2 Channel Timing Accuracy

See [DOCSIS PHYv3.1], section 7.4.2.2.

7.2.4.2.3 Modulation Timing Jitter

See [DOCSIS PHYv3.1], section 7.4.2.3.

7.2.4.3 Forward Error Correction

See [DOCSIS PHYv3.1], section 7.4.3.

7.2.4.4 Data Randomization

See [DOCSIS PHYv3.1], section 7.4.4.

7.2.4.5 Time and Frequency Interleaving and De-interleaving

See [DOCSIS PHYv3.1], section 7.4.5.

7.2.4.6 Mapping of Bits to Cell Words

See [DOCSIS PHYv3.1], section 7.4.6.

7.2.4.7 Mapping and Demapping Bits to/from QAM Subcarriers

See [DOCSIS PHYv3.1], section 7.4.7.

7.2.4.8 REQ Messages

See [DOCSIS PHYv3.1], section 7.4.8.

7.2.4.9 IDFT

See [DOCSIS PHYv3.1], section 7.4.9.

7.2.4.10 Cyclic Prefix and Windowing

See [DOCSIS PHYv3.1], section 7.4.10.

7.2.4.11 Burst Timing Convention

See [DOCSIS PHYv3.1], section 7.4.11.

7.2.4.12 FDX Fidelity Requirements

For FDX devices operating in FDX mode, this section augments the requirements of section 7.4.12.5 of [DOCSIS PHYv3.1] and corresponding subsections unless otherwise noted.

A DOCSIS FDX CM is required to generate 7 OFDMA channels as defined in Section 7.2.2.

A CM's Transmit Channel Set in the FDX spectrum (TCS_FDX), 108 MHz to 684 MHz, is the FDX OFDMA channels that can be transmitted by the CM in that band, independent of the current RBA in use. The FDX Allocated Spectrum has five possible values: 96 MHz, 192 MHz, 288 MHz, 384 MHz, and 576 MHz. The

upstream occupied bandwidth in the FDX Allocated Spectrum is the sum of the occupied bandwidth of all OFDMA channels in the cable modem's FDX transmit channel set. The bandwidth occupied by an OFDMA probe with a skip value of zero is equal to the upstream occupied bandwidth of an OFDMA channel. The FDX CM MUST comply with the Fidelity Requirements in this section.

7.2.4.12.1 Upstream Fidelity Measurement Framework

The Upstream Fidelity Measurement Framework for the FDX Band illustrated in Figure 6 is referenced for upstream channel power requirements that follow.

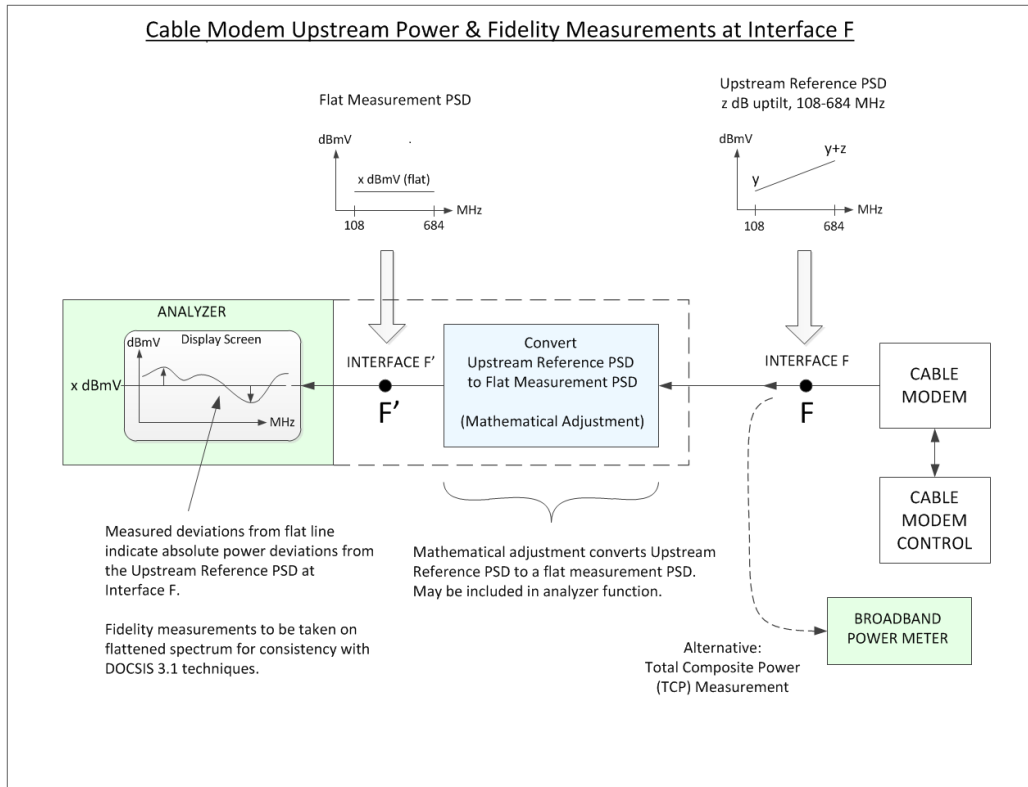

Figure 6 - FDX Cable Modem Upstream Power and Fidelity Measurements at Interface F

With $BW_{\text{OFDMA-FDX}}$ being the combined Occupied Bandwidth of the OFDMA channel(s) in its TCS_FDX , the CM is said to have $N_{\text{eq-FDX}} = \text{ceil}(BW_{\text{OFDMA-FDX}}(\text{MHz})/1.6 \text{ MHz})$ "equivalent DOCSIS channels" in its TCS_FDX .

An FDX CM MUST be capable of transmitting a total average output power of 65 dBmV.

An FDX CM MUST be capable of transmitting a total average output power of 64.5 dBmV in the FDX band. The FDX CM MUST be capable of transmitting a total average output power of 55 dBmV in the legacy US band when operating in FDX mode.

An FDX CM MAY be capable of transmitting a total average output power greater than 64.5 dBmV in the FDX Band.

Interface F has a requirement on the maximum TCP (total composite power) which is 64.5 dBmV, realized when the FDX modulated spectrum is at the maximum which is 570 MHz, and reduces from 64.5 dBmV as modulated spectrum reduces.

At Interface F, the Upstream Reference PSD is defined, which is a line in dB for the y-axis and linear frequency in the x-axis, and passes through the points 33.0 dBmV in 1.6 MHz centered at 108.8 MHz and 43.0 dBmV centered at 683.2 MHz.

At Interface F, the Dynamic Range Window (DRW_FDX) is defined, which is the result of adjustment relative to the Upstream Reference PSD, lowered by the amount commanded by the CMTS. The DRW_FDX is managed in the FDX spectrum in a similar manner as the DRW is managed in the legacy DOCSIS 3.1 upstream spectrum, but DRW_FDX and DRW are different. DOCSIS 3.1 CMs are still managed with the DOCSIS 3.1 DRW. DRW_FDX does not apply to DOCSIS 3.1 CMs.

Channel power adjustments within the FDX spectrum are managed similarly to the channel power adjustments in the legacy DOCSIS 3.1 upstream spectrum, which adjusts each individual channel PSD at or below the top of the DRW_FDX, and can also adjust an individual channel PSD above the top of the DRW_FDX a small amount.

Figure 6 illustrates the measurement for channel reported power accuracy and MER and spurious emissions for signals in the FDX spectrum. The test setup defining the measurements provides that a signal with the Upstream Reference PSD at Interface F has a flat PSD at Interface F'.

7.2.4.12.2 FDX Upstream Reference PSD

The channel reported power for an FDX CM for channels in the FDX spectrum are reported relative to the Upstream Reference PSD. The channel commanded power (per 1.6 MHz) for a channel at Interface F is, by definition, the channel power adjustments up or down from the Upstream Reference PSD.

The "equivalent channel power" of an FDX OFDMA channel is the average power at Interface F' of the OFDMA subcarriers of the channel normalized to 1.6 MHz bandwidth and referenced to the Upstream Reference PSD at Interface F'. This equivalent channel power of an OFDMA channel is denoted as $P_{1.6r_n-FDX}$. The TCS_FDX has zero to six OFDMA channels, but also is described as having N_{eq-FDX} number of equivalent DOCSIS channels.

Each channel in the TCS_FDX is described by its reported power $P_{1.6r_n-FDX}$, which is the channel power when it is fully granted and normalized to 1.6 MHz. The relation of the reported power to the expected true power of a fully granted channel is a function of the number of active subcarriers in the channel and their frequency. The reported power for each channel is referenced to Interface F' to simplify the upstream power management at the CMTS, which is generally expected to operate with a flat received PSD.

For an FDX CM, $P_{ref-FDX}$ is a parameter which is a function of frequency and is the power in dBmV in 1.6 MHz of subcarriers with no Pre-Equalization. $P_{ref-FDX}$ has a slope of (10 dB/360 slots of 1.6 MHz in the FDX Band) dBmV/1.6 MHz, and a total variation of 10.0 dB across 108 MHz to 684 MHz. $P_{ref-FDX}(108.8 \text{ MHz}) = 33.0 \text{ dBmV}/1.6 \text{ MHz}$ and $P_{ref-FDX}(683.2 \text{ MHz}) = 43.0 \text{ dBmV}/1.6 \text{ MHz}$. This corresponds to 64.5 dBmV TCP with 570 MHz modulated spectrum in the TCS_FDX ($N_{eq-FDX} = 357$). Note that there are no upstream SC-QAM channels in the FDX band.

Fidelity requirements apply with $P_{ref-FDX}$ for the transmit power spectral density, with 10 dB up tilt and no other channel adjustments or Pre-Equalization. Fidelity requirements also apply with 8 dB up tilt (and no other channel adjustments or Pre-Equalization beyond accomplishing the slope). Fidelity requirements with 1 dB additional allowance for spurious emissions, MER and Inband (compared to the 10 dB up tilt case) apply with 12 dB up tilt (and no other channel adjustments or Pre-Equalization beyond accomplishing the slope).

$P_{limit-FDX}$ is the maximum power per channel, increased from $P_{ref-FDX}$, for which only gradual degradation of fidelity requirements may be expected. $P_{limit-FDX}$ is 1.5 dB for upstream channels with no modulated spectrum above 300 MHz and is 1 dB for channels with any modulated spectrum above 300 MHz. Note that although some channels may be commanded above $P_{ref-FDX}$, and fidelity requirements may still apply, if the TCP exceeds P_{maxFDX} , then fidelity requirements do not apply.

The maximum power per any individual subcarrier, increased from $P_{ref-FDX}$, for which gradual degradation of fidelity requirements may be expected are given as follows: with any subcarrier power commanded more than 3 dB higher than $P_{ref-FDX}$, in any channel which has no modulated spectrum above 300 MHz; with any subcarrier power commanded more than 2.5 dB higher than $P_{ref-FDX}$, in any channel which has no modulated spectrum above 492 MHz but some modulated spectrum above 300 MHz; or with subcarrier power commanded more than 2.0 dB higher than $P_{ref-FDX}$, in any channel which has some modulated spectrum above 492 MHz. Note that although some subcarriers may be commanded above $P_{ref-FDX}$, and fidelity requirements may still apply, if the TCP exceeds P_{maxFDX} then fidelity requirements do not apply.

7.2.4.12.3 Maximum Scheduled Minislots

Maximum Scheduled Minislots are not supported for FDX CMs operating in FDX mode.

7.2.4.12.4 Transmit Power Requirements

The transmit power is a function of the number and occupied bandwidth of the OFDMA channels in the TCS_FDX, or equivalently the amount of TCS_FDX modulated spectrum and the frequency of the modulated spectrum. The highest value of the total power output in the FDX spectrum of the CM, $P_{\max\text{FDX}}$, is 64.5 dBmV and occurs when all the CM's potential FDX spectrum (108 MHz to 684 MHz) is occupied with OFDMA channels in its TCS_FDX and these are fully granted to the CM, and all channels are commanded to 0 dB channel power. The Upstream Reference PSD is denoted as $P_{\text{ref-FDX}}$ and is a function of frequency as defined in Section 7.2.4.12.2. When the TCS_FDX occupies a subset of the potential FDX spectrum, the TCP is reduced from 64.5 dBmV. The top of the Dynamic Range Window of the OFDMA FDX spectrum can be reduced from $P_{\text{ref-FDX}}$ by adjusting $P_{\text{load_min_set-FDX}}$ to a value greater than 0 dB. The OFDMA FDX spectrum's n^{th} channel power can be raised by a small amount (up to 1.5 dB in some portion of the FDX Band) when the top of the DRW_FDX is at $P_{\text{ref-FDX}}$, or reduced for any setting of the DRW_FDX. For example, the n^{th} channel power can be reduced by setting its $P_{1.6r_n\text{-FDX}}$ below 0 dB (negative), thereby reducing all the channel subcarriers from their power that was based on $P_{\text{ref-FDX}}$ and $P_{1.6r_n\text{-FDX}} = 0$ dB. There are limits on the amount of reduction as described below. This adjustability in channel power ensures that each channel can be set to a power range (within the DRW_FDX) between its maximum power, $P_{\text{ref-FDX}} - P_{\text{load_min_set-FDX}}$, or up to 1.5 dB higher in some portion of the FDX Band when $P_{\text{load_min_set-FDX}} = 0$, and minimum power, $P_{1.6\text{low-FDX}}$, and that any possible transmit grant combination can be accommodated without exceeding the transmit power capability of the CM.

For Full Duplex, $P_{1.6\text{low-FDX}} = P_{1.6\text{min-FDX}} = -15$ dB. Boosted pilots are not supported in the Full Duplex channels. Before completion of Fine Ranging, the FDX CM has no need to transmit with power per subcarrier which is lower than indicated by $P_{1.6\text{low-FDX}}$. These transmissions are prior to any data grant transmissions in the FDX band from the CM and as such the CM analog and digital gain balancing may be optimized for these transmissions.

When $P_{\text{load_min_set-FDX}}$ is 0 dB, the FDX CMTS SHOULD NOT command the FDX CM to set $P_{1.6r_n\text{-FDX}}$ on any channel in the TCS_FDX between 108 MHz and 300 MHz to a value more than 1.5 dB above the top of the DRW_FDX, or any channel in the TCS_FDX above 300 MHz, to a value more than 1 dB above the top of the DRW_FDX, or lower than the bottom of the DRW_FDX. When $P_{\text{load_min_set-FDX}}$ is greater than 0 dB, the FDX CMTS SHOULD NOT command the FDX CM to set $P_{1.6r_n\text{-FDX}}$ on any channel in the TCS_FDX to a value more than 0 dB above the top of the DRW_FDX, or lower than the bottom of the DRW_FDX.

If the FDX CMTS commands the FDX CM to exceed the top of the DRW_FDX, fidelity and performance requirements on the FDX CM do not apply, except for the following two narrow cases; with the 8 dB uptilt case spurious emissions and MER requirements are the same as with the 10 dB uptilt specified case; and with the 12 dB uptilt receiving 1 dB relaxation for spurious emissions and MER:

- 8 dB uptilt, 64.5 dBmV TCP: 1.3 dB higher (34.3 dBmV / 1.6 MHz) at 108.8 MHz and 0.7 dB lower (42.3 dBmV / 1.6 MHz) at 683.2 MHz.
- 12 dB uptilt, 64.5 dBmV TCP: 1.4 dB lower (31.6 dBmV / 1.6 MHz) at 108.8 MHz and 0.6 dB higher (43.6 dBmV / 1.6 MHz) at 683.2 MHz.

Table 8 summarizes the FDX upstream Reference PSD for different amount of spectral tilt as shown in Figure 6.

Table 8 - Reference PSD and Tilt (FDX)

Upstream Center Frequency	y (108.8 MHz)	y+z (683.2 MHz)	Spectral Tilt (dB)
Upstream Reference PSD (dBmV/1.6 MHz)	34.3	42.3	8
Upstream Reference PSD (dBmV/1.6 MHz)	33	43	10
Upstream Reference PSD (dBmV/1.6 MHz)	31.6	43.6	12

If $P_{\text{load_min_set-FDX}}$ is more than 0 dB, and the FDX CM is commanded to transmit on any channel in the TCS_FDX at a value higher than the top of the DRW_FDX or lower than the bottom of the DRW_FDX, the cable modem

indicates an error condition by setting the appropriate bit in the SID field of RNG-REQ messages for that channel until the error condition is cleared [DOCSIS MULPIv4.0].

If $P_{\text{load_min_set-FDX}}$ is 0 dB, and the FDX CM is commanded to transmit on any channel in the TCS_FDX at a value more than 1.5 dB higher than the top of the DRW_FDX for channels in 108 MHz to 300 MHz or more than 1 dB higher than the top of the DRW_FDX for channels higher than 300 MHz, or lower than the bottom of the DRW_FDX, the cable modem indicates an error condition by setting the appropriate bit in the SID field of RNG-REQ messages for that channel until the error condition is cleared [DOCSIS MULPIv4.0].

The FDX CMTS sends transmit power level commands and pre-equalizer coefficients to the FDX CM [DOCSIS MULPIv4.0] to compensate for upstream plant conditions. The top edge of the DRW_FDX is set to a level, $P_{-1.\text{load_min_set-FDX}}$, close to the highest $P_{1.6r_n\text{-FDX}}$ transmit channel to optimally load the DAC. In conditions of tilt significantly different than the nominal 10 dB tilt, some of the channels will be sent commands to transmit at lower $P_{1.6r_n\text{-FDX}}$ values that use up a significant portion of the DRW_FDX, and perhaps exceed the top of the DRW_FDX. Additionally, the pre-equalizer coefficients of the OFDMA channels will also compensate for plant tilts away from the nominal 10 dB. The FDX CMTS normally administers a DRW_FDX of 10 dB [DOCSIS MULPIv4.0] which is sufficient to accommodate plant tilts of up to +2 dB to -2 dB different from the specified tilt cases, 8 dB and 12 dB, and to accommodate plant flatness variations and loss variations as a function of frequency. Since the fidelity requirements are specified in flat frequency conditions at Interface F' relative to the top of the DRW_FDX, it is desirable to maintain FDX CM transmission power levels as close to the top of the DRW_FDX as possible. When conditions change sufficiently to warrant it, a global reconfiguration time should be granted and the top of the DRW_FDX adjusted to maintain the best transmission fidelity and optimize system performance.

7.2.4.12.4.1 FDX Transmit Power Detailed Requirements

For FDX CMs operating in FDX mode, Multiple Transmit Channel Mode is always enabled.

The FDX CM MUST support varying the amount of transmit power.

Requirements are presented for 1) range of reported transmit power per channel; 2) step size of power commands; 3) step size accuracy (actual change in output power per channel compared to commanded change); and 4) absolute accuracy of CM output power per channel. The protocol by which power adjustments are performed is defined in [DOCSIS MULPIv4.0]. The FDX CM MUST support such adjustments, commanded by the FDX CMTS, within the ranges of tolerances described below.

An FDX CM MUST confirm that the transmit power per channel limits are met after a RNG-RSP is received for each of the CM's active channels that is referenced and indicate that an error has occurred in the next RNG-REQ messages for the channel until the error condition is cleared [DOCSIS MULPIv4.0].

Some time after registration the FDX CMTS can initialize FDX operations for an FDX CM. During this process, the CM is assigned to a TG and receives FDX channel assignment via the Dynamic Bonding Request (DBC) mechanism. The group of active channels in the FDX Band assigned to a CM is known as the CM's Full Duplex Transmit Channel Set (TCS_FDX). If the FDX CMTS needs to add, remove, or replace channels in the CM's TCS_FDX, it uses the DBC-REQ Message with Transmit Channel Configuration encodings to define the new desired TCS_FDX. The set of channels actually bursting upstream from an FDX CM at any time could be all or a subset of the active channels on that FDX CM. Often one or all active channels on an FDX CM will not be bursting, but such quiet channels are still active channels for that FDX CM.

Transmit power per channel is defined as the average RF power in the occupied bandwidth (channel width), assuming equally likely QAM symbols, relative to the Upstream Reference PSD, measured at Interface F' of Figure 6 as detailed below. Reported transmit power for an OFDMA channel is expressed as $P_{1.6r_n\text{-FDX}}$ and is defined as the average RF power of the FDX CM transmission in the OFDMA channel, relative to the Upstream Reference PSD at Interface F' when transmitting in a grant composed of 64 25 kHz subcarriers or 32 50 kHz subcarriers. Total transmit power is defined as the sum of the transmit power per channel of each channel transmitting a burst at a given time.

The FDX CM MUST maintain its actual transmitted power per equivalent channel to within ± 2 dB of the reported power, $P_{1.6r_n\text{-FDX}}$, with pre-equalization off, taking into account symbol constellation values.

The FDX CM MUST allow its target transmit power per channel to vary over the range specified in Section 7.2.4.12.4, Transmit Power Requirements. The fidelity requirements do not apply when the FDX CM is

commanded to transmit at power levels which exceed the top of the DRW_FDX, except for the two narrow cases 8 dB up tilt and 12 dB up tilt.

The transmit channel loading $P_{1.6load_FDX}$ describes how close the transmit power level for a particular channel is to the top of the DRW_FDX. Let $P_{1.6load_FDX} = P_{ref_FDX} - P_{1.6r_n_FDX}$, for each channel, using the definitions for P_{ref_FDX} and $P_{1.6r_n_FDX}$ in the following subsections of Section 7.2.4.12. The channel corresponding to the minimum value of $P_{1.6load_FDX}$ is called the highest loaded channel, and its value is denoted as $P_{1.6load_1_FDX}$, in this specification even if there is only one channel in the Full Duplex Transmit Channel Set (TCS_FDX). A channel with high loading has a low $P_{1.6load_i_FDX}$ value; the value of $P_{1.6load_n_FDX}$ is analogous to an amount of back-off for an amplifier from its max power output, except that it is normalized to 1.6 MHz of bandwidth. A channel has lower power output when that channel has a lower loading (more back-off) and thus a higher value of $P_{1.6load_i_FDX}$. Note that the highest loaded channel is not necessarily the channel with the highest transmit power at Interface F' in Figure 6 since a channel's max power at Interface F' depends on the bandwidth of the channel. The channel with the second lowest value of $P_{1.6load_FDX}$ is denoted as the second highest loaded channel, and its loading value is denoted as $P_{1.6load_2_FDX}$; the channel with the i th lowest value of $P_{1.6load_FDX}$ is the i th highest loaded channel, and its loading value is denoted as $P_{1.6load_i_FDX}$.

$P_{1.6load_min_set_FDX}$ defines the upper end of the DRW_FDX for the FDX CM with respect to P_{ref_FDX} . $P_{1.6load_min_set_FDX}$ will normally limit the maximum power possible for each active channel to a value less than P_{ref_FDX} , but a commanded power adjustment can result in a violation of the DRW_FDX, in which case the FDX CM compliance with the fidelity requirements is not enforced, with two narrow exceptions for 8 dB up tilt and 12 dB up tilt described in the previous section. $P_{1.6load_min_set_FDX}$ is a value commanded to the FDX CM from the FDX CMTS when the FDX CM is given a TCC in Registration and RNG-RSP messages after Registration [DOCSIS MULPIv4.0]. $P_{1.6load_min_set_FDX}$, $P_{1.6load_n_FDX}$, P_{ref_FDX} , P_{limit_FDX} , $P_{1.6r_n_FDX}$, etc., are defined for DOCSIS FDX modems operating on a DOCSIS FDX CMTS. See Section 7.2.4.12.4 for a summary of these and other terms related to transmit power.

The FDX CMTS SHOULD command the FDX CM to use a value for $P_{1.6load_min_set_FDX}$ such that $P_{ref_FDX} - P_{1.6load_min_set_FDX} \geq P_{1.6low_n_FDX}$ for each active channel, with allowance for higher channel power up to P_{limit_FDX} in some channels, as long as P_{max_FDX} is maintained (to support different up tilt than 10 dB), or equivalently:

$$0 \leq P_{1.6load_min_set_FDX} \leq P_{ref_FDX} - P_{1.6low_n_FDX}$$

A value is computed, $P_{1.6low_multi_FDX}$, which sets the lower end of the transmit power DRW_FDX for that channel, given the upper end of the range which is determined by $P_{1.6load_min_set_FDX}$.

$$P_{1.6low_multi_FDX} = \max\{P_{ref_FDX} - P_{1.6load_min_set_FDX} - 10 \text{ dB}, P_{ref_FDX} - 15 \text{ dB}\}$$

The effect of $P_{1.6low_multi_FDX}$ is to restrict the dynamic range required (or even allowed) by a FDX CM across its multiple channels, when operating with multiple active channels.

The FDX CMTS SHOULD command a $P_{1.6r_n_FDX}$ consistent with the $P_{1.6load_min_set_FDX}$ assigned to the FDX CM and with the following limits (with allowance up to P_{limit_FDX} rather than P_{ref_FDX} to accommodate different up tilt than 10 dB):

$$P_{1.6load_min_set_FDX} \leq P_{ref_FDX} - P_{1.6r_n_FDX} \leq P_{1.6load_min_set_FDX} + 10 \text{ dB}$$

and the equivalent:

$$P_{ref_FDX} - (P_{1.6load_min_set_FDX} + 10 \text{ dB}) \leq P_{1.6r_n_FDX} \leq P_{ref_FDX} - P_{1.6load_min_set_FDX}$$

When the FDX CMTS sends a new value of $P_{1.6load_min_set_FDX}$ to the FDX CM, there is a possibility that the FDX CM will not be able to implement the change to the new value immediately, because the FDX CM may be in the middle of bursting on one or more of its upstream channels at the instant the command to change $P_{1.6load_min_set_FDX}$ is received at the FDX CM. Some amount of time may elapse before the FDX CMTS grants global reconfiguration time to the FDX CM. Similarly, commanded changes to $P_{1.6r_n_FDX}$ may not be implemented immediately upon reception at the FDX CM if the n th channel is bursting. Commanded changes to $P_{1.6r_n_FDX}$ may occur simultaneously with the command to change $P_{1.6load_min_set_FDX}$.

The FDX CMTS SHOULD NOT issue a change in $P_{1.6load_min_set_FDX}$ after commanding a change in $P_{1.6r_n_FDX}$ until after also providing a sufficient reconfiguration time on the n th channel. The FDX CMTS SHOULD NOT issue a

change in $P_{1.6load_min_set-FDX}$ after commanding a prior change in $P_{1.6load_min_set-FDX}$ until after also providing a global reconfiguration time for the first command.

Also, the FDX CMTS SHOULD NOT issue a change in $P_{1.6r_n-FDX}$ until after providing a global reconfiguration time following a command for a new value of $P_{1.6load_min_set-FDX}$ and until after providing a sufficient reconfiguration time on the n th channel after issuing a previous change in $P_{1.6r_n-FDX}$. In other words, the FDX CMTS is to avoid sending consecutive changes in $P_{1.6r_n-FDX}$ and/or $P_{1.6load_min_set-FDX}$ to the FDX CM without a sufficient reconfiguration time for instituting the first command.

When a concurrent new value of $P_{1.6load_min_set-FDX}$ and change in $P_{1.6r_n-FDX}$ are commanded, the FDX CM MAY wait to apply the change in $P_{1.6r_n-FDX}$ at the next global reconfiguration time (i.e., concurrent with the institution of the new value of $P_{1.6load_min_set-FDX}$) rather than applying the change at the first sufficient reconfiguration time of the n th channel. The value of $P_{1.6load_min_set-FDX}$ which applies to the new $P_{1.6r_n-FDX}$ is the concurrently commanded $P_{1.6load_min_set-FDX}$ value.

If the change to $P_{1.6r_n-FDX}$ falls outside the DRW_FDX of the old $P_{1.6load_min_set-FDX}$, then the FDX CM MUST wait for the global reconfiguration time to apply the change in $P_{1.6r_n-FDX}$.

The FDX CMTS SHOULD NOT command the FDX CM to decrease the per-channel transmit power if such a command would cause $P_{1.6load_n-FDX}$ for that channel to drop below $P_{1.6load_min_set-FDX}$.

Note that the FDX CMTS can allow small changes of power in the FDX CM's highest loaded channel without these fluctuations impacting the transmit power dynamic range with each such small change. This is accomplished by setting $P_{1.6load_min_set-FDX}$ to a smaller value than normal, and fluctuation of the power per channel in the highest loaded channel is expected to wander.

The FDX CMTS MUST NOT command a change of per channel transmit power or Pre-Equalization which could result in exceeding the CM's P_{maxFDX} in the FDX Band. If the FDX CMTS improperly commands the FDX CM to exceed P_{maxFDX} , the FDX CM informs the FDX CMTS of the error as described in [DOCSIS MULPIv4.0].

The FDX CMTS SHOULD NOT command a change of per channel transmit power which would result in $P_{1.6r_n-FDX}$ falling below the DRW_FDX , $P_{1.6r_n-FDX} < P_{1.6low_multi-FDX}$.

The FDX CMTS SHOULD NOT command a change in $P_{1.6load_min_set-FDX}$ such that existing values of $P_{1.6r_n-FDX}$ would fall outside the new DRW_FDX .

The following paragraphs define the FDX CM and FDX CMTS behavior in cases where there are DRW_FDX violations due to addition of a new channel with incompatible parameters without direct change of $P_{1.6r_n-FDX}$ or $P_{1.6load_min_set-FDX}$.

When adding a new active channel to the transmit channel set, the new channel's power is calculated according to the offset value defined in TLV 46.8.4 [DOCSIS MULPIv4.0], if it is provided.

The FDX CMTS SHOULD NOT set an offset value that will result in a $P_{1.6r_n-FDX}$ for the new channel outside the DRW_FDX . In the absence of the TLV, the new channel's power is initially set by the FDX CM at the minimum allowable power, i.e., the bottom of the DRW_FDX .

The FDX CM MUST maintain its actual transmitted power per every minislots within a burst constant to within 0.1 dB peak to valley even in the presence of power changes on other active channels. The 0.1 dB peak to valley does not include amplitude variation theoretically present in the signal (e.g., varying QAM constellations, transmit window). Specifically, within a continuous burst of duration up to n frames (1 millisecond), for each minislots participating in the burst and while the minislots is actively used for transmission, a constant power has to be maintained in that minislots within 0.1 dB peak to valley, even in the presence of a transmission starting or stopping on other minislots and other active channels.

The FDX CM MUST support the transmit power calculations defined in Section 7.2.4.12.5.

7.2.4.12.5 Transmit Power Calculations

The FDX CM determines its target transmit power per channel $P_{1.6t_n-FDX}$, as follows, for each channel which is active. Define for each active channel, for example, upstream channel n : $P_{1.6c_n-FDX}$ = Commanded Power for channel n . (TLV-17 in RNG-RSP).

$P_{1.6r_n_FDX}$ = reported power level (dBmV) of the FDX CM for channel n

P_{limit_FDX} = 1.5 dB for channels with no modulated spectrum above 300 MHz and 1.0 dB for channels with any modulated spectrum above 300 MHz

The FDX CM updates its reported power per channel in each channel by the following steps:

1. $\Delta P = P_{1.6c_n_FDX} - P_{1.6r_n_FDX}$
2. $P_{1.6r_n_FDX} = P_{1.6r_n_FDX} + \Delta P$ //Add power level adjustment (for each channel) to reported power level for each channel.

The FDX CMTS SHOULD ensure the following:

1. $P_{1.6r_n_FDX} \leq P_{limit_FDX}$, when $P_{1.6load_min_set_FDX} = 0$ //Clip at max power limit per channel unless the FDX CMTS accommodates a need to increase the PSD for the channel in which case the fidelity performance of the FDX CM is potentially degraded.
2. $P_{1.6r_n_FDX} \geq P_{1.6low_n_FDX}$ //Clip at min power limit per channel.
3. $P_{1.6r_n_FDX} \geq P_{1.6low_multi_FDX}$ //Power per channel from this command would violate the set DRW-FDX.
4. $P_{1.6r_n_FDX} \leq -P_{1.6load_min_set_FDX}$, when $P_{1.6load_min_set_FDX} > 0$ //Power per channel from this command violates the set DRW_FDX, but the FDX CMTS could accommodate a need to increase the PSD for the channel in which case the fidelity performance of the FDX CM is potentially degraded.

For OFDMA, the CM then transmits each data subcarrier with target power:

$$P_{t_sc_i} = P_{1.6r_n_FDX} + Pre-Eq_i - 10\log(\text{number_of subcarriers in 1.6 MHz } \{32 \text{ or } 64\})$$

where Pre-Eq_i is the magnitude of the ith subcarrier pre-equalizer coefficient (dB).

That is, the reported power for channel n, normalized to 1.6 MHz, plus the pre-equalization for the subcarrier, less a factor taking into account the number of subcarriers in 1.6 MHz.

Probe_{delta_n_FDX} for the nth FDX OFDMA channel is the change in subcarrier power for probes compared to subcarrier power for data depending on the mode as defined in [DOCSIS MULPIv4.0] in addition to Pre-Equalization on or off.

The FDX CM transmits probes with the same target power as given above plus Probe_{delta_n_FDX} when Pre-Equalization is enabled for probes in the P-MAP which provides the probe opportunity:

$$P_{t_sc_i} = P_{1.6r_n_FDX} + \text{Probe}_{\text{delta}_n_FDX} + Pre-Eq_i - 10\log(\text{number_of subcarriers in 1.6 MHz } \{32 \text{ or } 64\})$$

When the Pre-Equalization is disabled for the probe opportunity in the P-MAP, the FDX CM then transmits probe subcarrier with target power:

$$P_{t_sc_i} = P_{1.6r_n_FDX} + \text{Probe}_{\text{delta}_n_FDX} - 10\log_{10}(\text{number_of subcarriers in 1.6 MHz } \{32 \text{ or } 64\})$$

That is, the reported power for channel n, normalized to 1.6 MHz, less a factor taking into account the number of subcarriers in 1.6 MHz.

The total transmit power in channel n, P_{t_n} , in a frame is the sum of the individual transmit powers $P_{t_sc_i}$ of each subcarrier in channel n, where the sum is performed using absolute power quantities (non-dB domain).

The transmitted power level in channel n varies dynamically as the number and type of allocated subcarriers varies.

7.2.4.12.5.1 Terminology Used in Sections Covering FDX Upstream Transmit Power Requirements

This section provides a brief description of the terms used in elaboration of the transmit power requirements.

$BW_{\text{OFDMA-FDX}}$	The combined occupied bandwidth of the Full Duplex OFDMA channel(s) in the FDX Band Transmit Channel Set (TCS_FDX).
DRW_FDX	The dynamic range window of a Full Duplex channel.
$N_{\text{eq-FDX}}$	Number of Equivalent DOCSIS 1.6 MHz Upstream Channels in the cable modem's FDX Band Transmit Channel set (TCS_FDX). $N_{\text{eq}} = \text{ceil}(BW_{\text{OFDMA}} \text{ (MHz)}/1.6 \text{ MHz})$
$P_{1.6c_n_FDX}$	Commanded Power for Full Duplex channel n. (TLV-17 in RNG-RSP)

$P_{1.6load_j-FDX}$	The transmit channel loading $P_{1.6load_j-FDX}$. This describes how close the transmit power level for a particular channel is to the top of the DRW_FDX. The highest loaded Full Duplex channel $P_{1.6load_1-FDX}$ is the channel for which the reported power $P_{1.6r_n-FDX}$ is closest to the top of the DRW_FDX. In the case where there are j channels in the TCS_FDX, the lowest loaded channel $P_{1.6load_j-FDX}$ is the Full Duplex channel whose reported power $P_{1.6r_n-FDX}$ is furthest from the top of the DRW_FDX.
$P_{1.6load_min_set-FDX}$	The number of dB below $P_{ref-FDX}$ which defines the top of the DRW_FDX. The top of the Dynamic Range Window of the OFDMA FDX spectrum can be reduced from $P_{ref-FDX}$ by adjusting $P_{load_min_set-FDX}$ to a value greater than 0 dB.
$P_{1.6low-FDX}$	Minimum transmit power to which a CM can be configured to transmit in the FDX Band. OFDMA channels in the FDX Band do not have boosted pilots so $P_{1.6low-FDX} = P_{1.6Min-FDX}$.
$P_{1.6low_multi-FDX}$	Bottom of DRW_FDX.
$P_{1.6low_n-FDX}$	The minimum equivalent channel power for a particular FDX channel that the CM is permitted to support.
$P_{1.6min-FDX}$	Minimum transmit power to which a CM can be configured to transmit in the FDX Band. OFDMA channels in the FDX Band do not have boosted pilots so $P_{1.6low-FDX} = P_{1.6Min-FDX}$. $P_{1.6min-FDX} = -15$ dB.
$P_{1.6r_n-FDX}$	The equivalent channel power of an FDX OFDMA channel "n". $P_{1.6r_n-FDX}$ is the average power at interface F' of the OFDMA subcarriers of the channel normalized to 1.6 MHz bandwidth and referenced to the Upstream Reference Power Spectral Density at interface F' when the channel is fully granted. $P_{1.6r_n-FDX}$ is the channel power reported in the RNG-REQ messages. This is also referred to in the specification as Reported Transmit Power.
$P_{limit-FDX}$	The maximum power per channel, increased from $P_{ref-FDX}$ for which fidelity requirements only degrade gradually, when $P_{1.6load_min_set-FDX} = 0$. Fidelity requirements do not apply for channel power commanded higher than $P_{limit-FDX}$. Fidelity requirements do not apply whenever TCP exceeds P_{maxFDX} .
P_{maxFDX}	The maximum total transmit power that the CM can support in the FDX Band. The default value and the lowest allowable value for P_{maxFDX} is 64.5 dBmV. Fidelity requirements do not apply if Total Channel Power exceeds P_{maxFDX} .
$P_{ref-FDX}$	The upstream reference power spectral density in the Full Duplex Band. $P_{ref-FDX}$ is the power in dBmV in 1.6 MHz of subcarriers with no pre-equalization. $P_{ref-FDX}$ at 108.8 MHz is 33.0 dBmV/1.6 MHz and $P_{ref-FDX}$ at 683.2 MHz is 43.0 dBmV/1.6 MHz for a slope of (10 dB/360 slots of 1.6 MHz in the FDX Band) dBmV/1.6 MHz, and a total variation of 10.0 dB across 108 MHz to 684 MHz.
P_{t_n-FDX}	The total transmit power in a channel n in the FDX Band.
$P_{t_sc_i}$	The average target power transmitted by the i^{th} subcarrier for either probes or other transmissions, possibly with different power for the probe transmissions (see $Probe_{delta_n-FDX}$ below).
Pre-Eq $_i$	The magnitude of the i^{th} subcarrier pre-equalizer coefficient (dB).
$Probe_{delta_n-FDX}$	This term is used to account for reduction in Probe power resulting from the Power bit and Start Subc bits in the Probe Information Element in the P-MAP for the n^{th} FDX OFDMA channel.
TCS_FDX	A cable modem's Transmit Channel Set in the FDX Band (108 MHz to 684 MHz).

7.2.4.12.6 Reconfiguration Time for FDX CMs

In an FDX DOCSIS system, there are two independent transmission channel sets: one for the legacy upstream channels (TCS), and one for the FDX upstream channels (TCS_FDX).

Section 7.2.4.12.4 of [DOCSIS PHYv3.1] applies to TCS only, while this section applies to TCS_FDX.

Reconfiguration time for FDX upstream channels is the inactive time interval provided between active upstream transmissions on a given FDX upstream channel when a change is commanded for a transmission parameter on that channel. For changes in the Ranging Offset and/or Pre-Equalization of an FDX upstream channel, the FDX CM MUST be able to transmit consecutive bursts as long as the CMTS allocates the time duration (reconfiguration time) of at least one inactive frame in between the bursts on the FDX upstream channel with the changed parameter.

"Global reconfiguration time" in the FDX upstream channels is defined as the inactive time interval provided between active FDX upstream transmissions, which simultaneously satisfies the requirement in this section for all OFDMA channels in the TCS_FDX.

Global "quiet" across all active FDX upstream channels requires the intersection of ungranted burst intervals across all active OFDMA FDX channels to be at least 20 microseconds. Even with a change or re-command of $P_{1.6load_min_set-FDX}$, the FDX CM MUST be able to transmit consecutive bursts as long as the FDX CMTS allocates at least one frame in between bursts, across all OFDMA channels in the TCS_FDX, where the quiet lapses in each channel contain an intersection of at least 20 microseconds. (From the end of a burst on one FDX upstream channel

to the beginning of the next burst on any other FDX upstream channel, there is to be at least 20 microseconds duration to provide a "global reconfiguration time" for all channels in the FDX CM's TCS_FDX.)

The FDX CMTS SHOULD provide global reconfiguration time to the TCS_FDX for the FDX CM before (or concurrently as) the FDX CM has been commanded to change any upstream channel transmit power in the TCS_FDX by ± 3 dB cumulative since its last global reconfiguration time.

Global Reconfiguration Time for the legacy upstream channels (TCS) is completely disassociated with TCS_FDX grants or commands to the FDX CM, and Global Reconfiguration Time for the FDX upstream channels (TCS_FDX) is completely disassociated with the TCS grants or commands to the FDX CM.

A resource block allocation change does not require a reconfiguration time. Imposed "quiet" time (no grants) on FDX upstream channels with a status change indicated by a resource block allocation is described in [DOCSIS MULPIv4.0]. No "quiet" time is required on an FDX upstream channel with a resource block allocation change which maintains the upstream status of the FDX channel.

7.2.4.12.7 Fidelity Requirements for FDX

The following requirements assume that any pre-equalization is disabled, unless otherwise noted. Signal power and measurements are all referenced to Interface F' of Figure 6.

When channels in the TCS_FDX are commanded to the same equivalent channel powers, the reference signal power in the "dBc" definition is to be interpreted as the measured average total transmitted power at Interface F'. When channels in the TCS_FDX are commanded to different equivalent channel powers, the commanded total power of the transmission is computed, and a difference is derived compared to the commanded total power which would occur if all channels had the same $P_{1,6r,n-FDX}$ as the highest equivalent channel power in the TCS_FDX, whether or not the channel with the largest equivalent channel power is included in the grant. Then this difference is added to the measured total transmit power to form the reference signal power for the "dBc" spurious emissions requirements.

7.2.4.12.7.1 Spurious Emissions for FDX

The noise and spurious power generated by the FDX CM MUST NOT exceed the levels given in Table 9 - Spurious Emissions, Table 10 - Spurious Emissions Requirements in the Upstream Frequency Range for Grants of Under-grant Hold Bandwidth and Larger, and Section 7.2.4.12.7.1.2, Adjacent Channel Spurious Emissions.

Up to five discrete spurs can be excluded from the emissions requirements listed in Table 9 and Table 10 for each of the spectral regions 85 MHz to 300 MHz, 300 MHz to 492 MHz, 492 MHz to 684 MHz, 684 MHz to 804 MHz, and 804 MHz to 1218 MHz, while the CM is Transmitting Burst upstream in the FDX band. The five excluded discrete spurs have to be no more than 2 dB in excess of the MER value of Table 12, with 100% grant, relative to a single subcarrier power level at the top of the DRW_FDX.

For example, with 12 dB up tilt at 108 MHz, the MER requirement from Table 12 is 36 dB, and so a discrete spur at 108 MHz, if one of the five to be excluded in the range of 85 MHz to 300 MHz, could reach as high as -34 dBc and still qualify for exclusion, where 0 dBc corresponds to the power in a subcarrier at the top of the DRW_FDX at 108 MHz. For the exclusions in the spectral regions 684 MHz to 804 MHz and 804 MHz to 1218 MHz, the exclusion limit corresponds to the value 2 dB relaxed from the MER requirement at 684 MHz, and the 0 dBc reference is the top of the DRW_FDX at 684 MHz. For the exclusions in the spectral region 85 MHz to 108 MHz, the exclusion limit corresponds to the value 2 dB relaxed from the MER requirement at 108 MHz, and the 0 dBc reference is the top of the DRW_FDX at 108 MHz. In each band (5 MHz to 85 MHz; 108 MHz to 300 MHz; 300 MHz to 492 MHz; 492 MHz to 684 MHz; 684 MHz to 804 MHz; and 804 MHz to 1218 MHz) up to 3 discrete spurs up to -40 dBmV may be excluded from the Between Burst requirements, and also 3 such discrete spur exclusions up to -40 dBmV for the 5 MHz to 85 MHz Transmitting Burst requirement. Only a total of ten different discrete spur exclusion frequencies are allowed in 5 MHz to 1218 MHz. The ten different exclusion frequencies are allowed, with the limitation of five or three per band as described above, but these ten exclusion frequencies are applied to all tests; a different set of ten exclusion frequencies is NOT allowed for different tests and different modes.

SpurFloor is defined as:

$$\text{SpurFloor} = -51.8 \text{ dBc}$$

Under-grant Hold Number of Users is defined as:

$$\text{Under-grant Hold Number of Users} = \text{Floor}\{ 0.2 + 10^{(-44 - \text{SpurFloor})/10} \} = 6$$

Under-grant Hold Bandwidth (UGHB) is defined as:

$$\text{Under-grant Hold Bandwidth} = (\text{Full Duplex Allocated Spectrum})/(\text{Under-grant Hold Number of Users})$$

The spurious performance requirements defined above only apply when the FDX CM is operating within certain ranges of values for $P_{1.6\text{load}_i\text{-FDX}}$, for $i = 1$ to the number of upstream channels in the TCS_FDX, and for granted bandwidth of Under-grant Hold Bandwidth or larger; where $P_{1.6\text{load}_1\text{-FDX}}$ is the highest loaded channel in this specification (i.e., its power is the one closest to $P_{\text{ref-FDX}}$).

When a modem is transmitting over a bandwidth of less than Under-grant Hold Bandwidth the spurious emissions requirement limit is the power value (in dBmV per 1.6 MHz), corresponding to the specifications for the power level associated with a grant of bandwidth equal to Under-grant Hold Bandwidth.

The FDX CM MUST meet the spurious emissions performance requirements when the equivalent DOCSIS channel powers ($P_{1.6r_n\text{-FDX}}$) are within 0-6 dB below the top of the DRW_FDX ($P_{1.6\text{load}_\text{min_set-FDX}} + 6 \geq P_{1.6\text{load}_i\text{-FDX}} \geq P_{1.6\text{load}_\text{min_set-FDX}}$) but is not required to meet spurious emissions performance requirements when $P_{1.6r_n\text{-FDX}}$ are not within this range.

Further, the FDX CM MUST meet the spurious emissions performance requirements when $P_{1.6\text{load}_1\text{-FDX}} = P_{1.6\text{load}_\text{min_set-FDX}}$. When $P_{1.6\text{load}_1\text{-FDX}} > P_{1.6\text{load}_\text{min_set-FDX}}$, the spurious emissions requirements in absolute terms are relaxed by $P_{1.6\text{load}_1\text{-FDX}} - P_{1.6\text{load}_\text{min_set-FDX}}$ but is not required to meet spurious emissions performance requirements when this condition is not met.

The spurious performance requirements do not apply to any upstream channel from the time the output power on any active upstream channel has varied by more than ± 3 dB since the last global reconfiguration time through the end of the next global reconfiguration time changes.

In Table 9, in-band spurious emissions include noise, carrier leakage, clock lines, synthesizer spurious products, and other undesired transmitter products. It does not include ISI. The measurement bandwidth for in-band spurious emissions for OFDM is equal to the Subcarrier Clock Frequency (25 kHz or 50 kHz) and is not a synchronous measurement. The signal reference power for OFDMA in-band spurious emissions is the total transmit power measured and adjusted (if applicable) as described in Section 7.2.4.12.7, and then apportioned to a single data subcarrier.

The measurement bandwidth is 4 MHz for the Between Bursts (none of the channels in the TCS_FDX is bursting) specs of Table 9. The signal reference power for Between Bursts transmissions, "0 dBr", is the PSD for the top of the DRW_FDX, as measured at Interface F'.

The Transmitting Burst specs apply during the minislots granted to the FDX CM in the FDX Band (when the FDX CM uses all or a portion of the grant), and for 20 μ s before and after the granted minislot for OFDMA. The Between Bursts specs apply except during a used grant of minislots on any active channel in the FDX Band for the FDX CM, and 20 μ s before and after the used grant for OFDMA. In Table 9 entries, the signal reference power, "0 dBr", is the PSD for the top of the DRW_FDX, as measured at Interface F'.

For the purpose of spurious emissions definitions, a granted burst refers to a burst of minislots to be transmitted at the same time from the same FDX CM; these minislots are not necessarily contiguous in frequency.

For Initial Ranging and before completion of Fine Ranging, spurious emissions requirements use Table 9 and Table 10, and if transmissions use subcarrier power which is X dB lower than indicated by $P_{1.6\text{low-FDX}}$, then the spurious emissions requirements in absolute terms are relaxed by X dB.

Spurious emissions requirements for grants of 10% or less of the FDX Allocated Spectrum may be relaxed by 2 dB in an amount of spectrum equal to:

$$\text{measurement BW} * \text{ceil}(10\% \text{ of the FDX Allocated Spectrum} / \text{measurement BW})$$

anywhere in the whole upstream spectrum for emission requirements specified in Table 10.

A 2 dB relief applies in the measurement bandwidth. This relief does not apply to between bursts emission requirements.

The FDX CMTS MUST NOT command a grant to the FDX CM in the FDX Band which is smaller than the Minimum Grant Bandwidth shown in Table 10 - Spurious Emissions Requirements in the Upstream Frequency Range for Grants of Under-grant Hold Bandwidth and Larger, which is 5.2 MHz with 96 MHz FDX Allocated Spectrum, 10.4 MHz with 192 MHz FDX Allocated Spectrum, 16.0 MHz with 288 MHz FDX Allocated Spectrum, 21.2 MHz with 384 MHz FDX Allocated Spectrum, and 32.0 MHz with 576 MHz FDX Allocated Spectrum.

Table 9 - Spurious Emissions

Parameter	Transmitting Burst ^{1,5,10,11,12,14,16}	Between Bursts ^{5,10,11,12,15,16}
Inband (Modulated spectrum of the grant)	-42 dBr OFDMA 100% grant ^{4,5,6,8,9} -47 dBr OFDMA UGHB% grant ^{4,5,6,8,9}	Max{-72 dBr, -43 dBmV} See Note 7
Adjacent Minislot (adjacent to the modulated spectrum of the grant) 400 kHz next to modulated spectrum	+ 0.2 dB relaxation. See Table 10	Same as for Inband See Note 7
FDX Band Within 108 MHz to 684 MHz (excluding assigned channel, adjacent channels).	See 7.2.4.12.7.1.2	Same as for Inband See Note 7
Requirements for the emissions from 5 MHz – 108 MHz and 684 MHz and above CM Integrated Spurious Emissions Limits (all in 4 MHz, includes discretely) ¹		
5 MHz to 85 MHz	-45 dBmV	-50 dBmV
85 MHz to 108 MHz	-35 dBr	Same as Inband
684 MHz to 804 MHz	-42 dBr	Same as Inband - Note 7
804 MHz to 1218 MHz	-45 dBmV	-45 dBmV
For the case where the upstream operating range is 108 MHz to 684 MHz: CM Discrete Spurious Emissions Limits ¹	For all four bands: Largest Discrete Spurious Emissions at least 5 dB lower power than the limit on Integrated Spurious Emissions in 4 MHz, in the same band (see table row above)	5-85 MHz Largest Discrete Spurious Emissions at least 3 dB lower power than the limit on Integrated Spurious Emissions in 4 MHz, in the same band (see table row above) 85 MHz to 108 MHz 684 MHz to 804 MHz 804 MHz to 1218 MHz Largest Discrete Spurious Emissions at least 5 dB lower power than the limit on Integrated Spurious Emissions in 4 MHz, in the same band (see table row above)

Parameter	Transmitting Burst ^{1,5,10,11,12,14,16}	Between Bursts ^{5,10,11,12,15,16}
<p>Table Notes:</p> <p>Note 1. Up to 5 discrete spurs in each of the following bands may be excluded: 85-300 MHz; 300-492 MHz; 492-684 MHz; 684-804 MHz; and 804-1218 MHz, while the CM is Transmitting Burst in the FDX band. These 5 spurs are the same spurs that may be excluded for spurious emissions and MER and not an additional or different set.</p> <p>Note 2. N/A.</p> <p>Note 3. N/A.</p> <p>Note 4. N/A.</p> <p>Note 5. This value is to be met when $P_{1,load} = P_{1,load_min_set}$. "0 dBr" is referenced to the top of the DRW_FDX.</p> <p>Note 6. Receive equalization is allowed if an MER test approach is used, to take ISI out of the measurement; measurements other than MER-based to find spurs or other unwanted power may be applied to this requirement.</p> <p>Note 7. Between Burst spurious emissions in this 108-684 MHz is limited to -66 dBr when CM is transmitting background Echo Cancellation Training signal, and limited to -60 dBr in 684-804 MHz.</p> <p>Note 8. Frequency-Dependent Relaxation as a function of the measurement center frequency, linearly scales in frequency from 5 dB at 108 MHz to 0 dB at 684 MHz.</p> <p>Note 9. 1 dB relaxation with 12 dB uptilt.</p> <p>Note 10. "dBr" values measured at Interface F, "dBmV" values measured at Interface F, and all measurements and averages computed over 4 MHz bandwidth unless noted otherwise.</p> <p>Note 11. Transmitting Burst is with FDX Band upstream bursting, and Between Burst is with FDX Band upstream between bursts entirely in 108-684 MHz.</p> <p>Note 12. For all the requirements except for the 5-85 MHz and 85-108 MHz, both Transmitting Burst and Between Burst, the requirements need to be met with the legacy upstream (5-85 MHz) bursting. With the requirements in 5-85 MHz and 85-108 MHz, the requirements need to be met with the legacy upstream (5-85 MHz) between bursts.</p> <p>Note 13. No fidelity requirements when transmitting CW Tones for Sounding.</p> <p>Note 14. Allowance for 3 excluded discrete spurs up to -40 dBmV in the 5-85 MHz while Transmitting Burst.</p> <p>Note 15. Allowance for 3 excluded discrete spurs in each of the bands (5-85; 85-300; 300-492; 492-684; 684-804; and 804-1218 MHz) up to -40 dBmV while Between Bursts.</p> <p>Note 16. For the discrete spur exclusions of Note 1, Note 14, and Note 15, a total of ten different such exclusion frequencies are allowed to be applied for all the requirements, across the full 5-1218 MHz range, while also accommodating the restrictions on the number of exclusions in any one band. The ten exclusion frequencies are not allowed to change for application to different requirements, nor due to changes in mode in the CM under test.</p>		

7.2.4.12.7.1.1 Spurious Emissions in the Upstream FDX Frequency Range

Table 10 lists the required spurious level in a measurement interval. The initial measurement interval at which to start measuring the spurious emissions (from the transmitted burst's modulation edge) is 400 kHz from the edge of the transmission's modulation spectrum. Measurements should start at the initial distance and be repeated at increasing distance from the carrier, until the upstream band edge or spectrum adjacent to another modulated spectrum is reached.

In addition to the spurious emissions level generated in Table 11, there is a frequency-dependent relaxation provided as a function of the center frequency of the measurement, which is given in Table Note 3 of Table 11 as:

$$\text{Frequency-Dependent_Spurious_Emissions_Relaxation} = 5 * (684 \text{ MHz} - \text{measurement_center_frequency}) / (684 \text{ MHz} - 108 \text{ MHz}) \text{ dB.}$$

For example, with 576 MHz FDX Allocated Spectrum and 96 MHz grant, the requirement is -61.8 dBc at 679.2 MHz and -56.8 dBc at 112.8 MHz.

For OFDMA transmissions with non-zero transmit windowing, the FDX CM MUST meet the required performance measured within the 2.0 MHz adjacent to the modulated spectrum using slicer values from an FDX CMTS burst receiver or equivalent, synchronized to the downstream transmission provided to the FDX CM.

In the rest of the spectrum, the FDX CM MUST meet the required performance measured with a bandpass filter (e.g., an unsynchronized measurement).

For OFDMA transmissions with zero transmit windowing, the FDX CM MUST meet the required performance using synchronized measurements across the complete upstream spectrum.

Spurious emissions allocation for far out spurious emissions =

$$\text{Round} \{ \text{SpurFloor} + 10^{\ast_{\log_{10}}(\text{Measurement bandwidth}/\text{Under-grant hold Bandwidth}), 0.1} \}.$$

For transmission bursts with modulation spectrum less than the Under-grant Hold Bandwidth, the spurious power requirement is calculated as above, but increased by $10^{\ast_{\log_{10}}(\text{Under-grant Hold Bandwidth}/\text{Grant Bandwidth})}$.

Table 10 - Spurious Emissions Requirements in the Upstream Frequency Range for Grants of Under-grant Hold Bandwidth and Larger

FDX Allocated Spectrum (MHz)	Minimum Grant Bandwidth (MHz)	SpurFloor (dBc)	Under-grant Hold #Users	Under-grant Hold Bandwidth (MHz)	Measurement Bandwidth (MHz) ¹	Specification in the Interval (dBc) ^{2,3}
96	5.2	- 51.8	6	16	9.6	-54.0
192	10.4	- 51.8	6	32	9.6	-57.0
288	16.0	- 51.8	6	48	9.6	-58.8
384	21.2	- 51.8	6	64	9.6	-60.0
576	32.0	- 51.8	6	96	9.6	-61.8

Table Notes:

Note 1. The measurement bandwidth is a contiguous sliding measurement window.

Note 2. Frequency-Dependent Relaxation as a function of the measurement center frequency, linearly scales in frequency from 5 dB at 108 MHz to 0 dB at 684 MHz.

Note 3. 1 dB relaxation with 12 dB uptilt

The FDX CM MUST control transmissions such that within the measurement bandwidth of Table 10 - Spurious Emissions Requirements in the Upstream Frequency Range for Grants of Under-grant Hold Bandwidth and Larger, spurious emissions measured for individual subcarriers contain no more than +3 dB power larger than the required average power of the spurious emissions in the full measurement bandwidth divided by the number of subcarriers in the measurement bandwidth. When non-synchronous measurements are made, only 25 kHz measurement bandwidth is used.

For OFDMA transmissions, bandpass measurements rather than synchronous measurements may be applied.

7.2.4.12.7.1.2 Adjacent Channel Spurious Emissions

Spurious emissions from a transmitted burst may occur in adjacent spectrum, which could be occupied by OFDMA subcarriers transmitted by another CM.

The spurious emissions requirements for adjacent spectrum to a transmitted burst are given in Table 10 but with an additional 0.2 dB allowance, where the measurement is over the 9.6 MHz spectrum adjacent to the modulated spectrum.

The measurement is performed starting on an adjacent subcarrier of the transmitted spectrum (both above and below), using the slicer values from a CMTS burst receiver or equivalent synchronized to the downstream transmission provided to the CM.

The FDX CM MUST control transmissions such that within the adjacent 400 kHz of modulated spectrum, spurious emissions measured for individual subcarriers contain no more than +5 dB power larger than the required average power of the spurious emissions in the full measurement bandwidth divided by the number of subcarriers in the measurement bandwidth.

For the 9.2 MHz measurement bandwidth which is outside the 400 kHz adjacent to the modulated spectrum, the FDX CM MUST control transmissions such that spurious emissions measured for individual subcarriers contain no more than +3 dB power larger than the required average power of the spurious emissions in the full measurement bandwidth divided by the number of subcarriers in the measurement bandwidth. For any portion of the 9.6 MHz measurement bandwidth where non-synchronous measurements are made, only 25 kHz measurement bandwidth is used.

Bandpass measurements rather than synchronous measurements may be applied where possible.

7.2.4.12.7.1.3 Spurious Emissions During FDX Burst On/Off Transients

The FDX CM MUST control spurious emissions prior to and during ramp-up, during and following ramp-down, and before and after a burst.

The FDX CM's on/off spurious emissions, such as the change in voltage at the upstream transmitter output, due to enabling or disabling transmission, MUST be no more than 50 mV.

The FDX CM's voltage step MUST be dissipated no faster than 4 μ s of constant slewing. This requirement applies when the FDX CM is transmitting at +55 dBmV or more per channel on any channel.

At backed-off transmit levels, the FDX CM's maximum change in voltage MUST decrease by a factor of 2 for each 6 dB decrease of power level in the highest power active channel, from +55 dBmV per channel, down to a maximum change of 3.5 mV at 31 dBmV per channel and below. This requirement does not apply to FDX CM power-on and power-off transients.

7.2.4.12.7.2 FDX OFDMA MER Requirements

Transmit modulation error ratio (TxMER or just MER) measures the cluster variance caused by the FDX CM during upstream transmission due to transmitter imperfections. The terms "equalized MER" and "unequalized MER" refer to a measurement with linear distortions equalized or not equalized, respectively, by the test equipment receive equalizer. The requirements in this section refer only to unequalized MER, as described for each requirement. MER is measured on each modulated data subcarrier and non-boosted pilot (MER is computed based on the unboosted pilot power) in a minislot of a granted burst and averaged for all the subcarriers in each minislot. MER includes the effects of Inter-Carrier Interference (ICI), spurious emissions, phase noise, noise, distortion, and all other undesired transmitter degradations with an exception for a select number of discrete spurs impacting a select number of subcarriers. MER requirements are measured with a calibrated test instrument that synchronizes to the OFDMA signal, applies a receive equalizer in the test instrument that removes MER contributions from nominal channel imperfections related to the measurement equipment, and calculates the value. The equalizer in the test instrument is calculated, applied and frozen for the CM testing. Receiver equalization of FDX CM linear distortion is not provided; hence, this is considered to be a measurement of unequalized MER, even though the test equipment contains a fixed equalizer setting.

7.2.4.12.7.2.1 Definitions

MER is defined as follows for OFDMA. The transmitted RF waveform at the F connector of the CM (after appropriate down conversion) is filtered, converted to baseband, sampled, and processed using standard OFDMA receiver methods, with the exception that receiver equalization is not provided. The processed values are used in the following formula. No external noise (AWGN) is added to the signal.

The carrier frequency offset, carrier amplitude, carrier phase offset, and timing will be adjusted during each burst to maximize MER as follows:

- One carrier amplitude adjustment common for all subcarriers and OFDM symbols in burst.
- One carrier frequency offset common for all subcarriers resulting in phase offset ramping across OFDM symbols in bursts.
- One timing adjustment resulting in phase ramp across subcarriers.
- One carrier phase offset common to all subcarriers per OFDM symbol in addition to the phase ramp.

MER_i is computed as an average of all the subcarriers in a minislot for the i^{th} minislot in the OFDMA grant:

$$MER_i \text{ (dB)} = 10 \cdot \log_{10} \left(\frac{E_{avg}}{\frac{1}{N} \sum_{j=1}^N \left(\frac{1}{M} \sum_{k=1}^M |e_{j,k}|^2 \right)} \right)$$

where:

E_{avg} is the average constellation energy for equally likely symbols,

M is the number of symbols averaged,

N is the number of subcarriers in a minislot,

$e_{j,k}$ is the error vector from the j^{th} subcarrier in the minislot and k^{th} received symbol to the ideal transmitted QAM symbol of the appropriate modulation order.

A sufficient number of OFDMA symbols are to be included in the time average so that the measurement uncertainty from the number of symbols is less than other limitations of the test equipment.

MER with a 100% grant is defined as the condition when all OFDMA non-excluded subcarriers in the transmit channel set are granted to the FDX CM. For purposes of testing MER, a grant of all OFDMA minislots in the transmit channel set may be used; there may be non-excluded subcarriers that are not within minislots.

MER with a UGHB is defined as the condition when less than or equal to UGHB of the FDX OFDMA minislots have been granted to the FDX CM.

7.2.4.12.7.2.2 FDX Requirements

Unless otherwise stated, the FDX CM MUST meet or exceed the following MER limits over the full transmit power range, all modulation orders, all grant configurations and over the full upstream frequency range.

The following flat channel measurements (ideally flat channel except for downtilt specified between Interface F and F') with the transmitted specified up tilt (Table 11) are made after the pre-equalizer coefficients have been set to their optimum values. The receiver uses best effort synchronization to optimize the MER measurement.

Table 11 - Upstream MER Requirements (with Pre-Equalization)

Parameter	Value
MER (100% grant)	Each minislot MER \geq 42 dB (Notes 1, 2, 3, 4, 5) at 684 MHz with 8 dB and 10 dB up tilt
MER (UGHB % grant)	Each minislot MER \geq 47 dB (Notes 1, 2, 3, 4) at 684 MHz with 8 dB and 10 dB up tilt
Pre-equalizer constraints	Coefficients set to their optimum values
Table Notes:	
Note 1. Up to 5 subcarriers within the entire upstream bandwidth with discrete spurs may be excluded from the MER calculation if they fall within transmitted minislots. These 5 spurs are the same spurs that may be excluded for spurious emissions and not an additional or different set.	
Note 2. This value is to be met when $P_{1,6load} = P_{1,6load_min_set}$.	
Note 3. Frequency-Dependent Relaxation as a function of the measurement center frequency, linearly scales in frequency from 5 dB at 108 MHz to 0 dB at 684 MHz.	
Note 4. 1 dB relaxation with 12 dB up tilt	
Note 5. For testing 100% grant, a grant of all OFDMA minislots may be used.	

The following flat channel measurements (Table 12) are made with the pre-equalizer coefficients set to unity and with the transmitted specified up tilt and the receiver implementing best effort synchronization. For this measurement, the receiver may also apply partial equalization. The partial equalizer is not to correct for the portion of the CM's time-domain impulse response greater than 200 ns or frequency-domain amplitude response greater than +1 dB or less than -3 dB from the average amplitude. An additional 1 dB attenuation in the amplitude response is allowed in the upper 10% of the specified passband frequency. It is not expected that the partial equalizer is implemented on CMTS receiver. A partial equalizer could be implemented offline via commercial receivers or simulation tools.

Table 12 - Upstream MER Requirements (no Pre-Equalization)

Parameter	Value
MER (100% grant)	Each minislot MER \geq 39 dB (Notes 1, 2, 3, 4) at 684 MHz with 8 dB and 10 dB up tilt
MER (UGHB% grant)	Each minislot MER \geq 39 dB (Notes 1, 2, 3, 4) at 684 MHz with 8 dB and 10 dB up tilt
Pre-equalizer constraints	Pre-equalization not used

Parameter	Value
Table Notes:	
Note 1. Up to 5 subcarriers within the entire upstream bandwidth with discrete spurs may be excluded from the MER calculation if they fall within transmitted minislots. These 5 spurs are the same spurs that may be excluded for spurious emissions and not an additional or different set.	
Note 2. This value is to be met when $P_{1.6load} = P_{1.6load_min_set}$.	
Note 3. Frequency-Dependent Relaxation as a function of the measurement center frequency, linearly scales in frequency from 5 dB at 108 MHz to 0 dB at 684 MHz.	
Note 4. 1 dB relaxation with 12 dB uptilt	

7.2.4.13 Cable Modem Transmitter Output Requirements in the FDX Band

For FDX devices operating in FDX mode, this section augments section 7.4.13 of [DOCSIS PHYv3.1] and corresponding subsections unless otherwise noted.

The FDX CM MUST output an RF Modulated signal with characteristics delineated in Table 13 - CM Transmitter Output Signal Characteristics for the FDX Band.

Table 13 - CM Transmitter Output Signal Characteristics for the FDX Band

Parameter	Value																		
Frequency	108 MHz to 684 MHz																		
Signal Type	OFDMA																		
Maximum OFDMA Channel Bandwidth	95 MHz																		
Minimum OFDMA Encompassed Spectrum	86 MHz per Sub-band (Notes 1, 2 below)																		
Number of Independently Configurable OFDMA Channels	The downstream channel and upstream channels sharing the same sub-band are configured to the same subcarrier spacing and cyclic prefix length. The subcarrier spacing and cyclic prefix on different sub-bands are allowed to be different.																		
Subcarrier Channel Spacing	25 kHz, 50 kHz																		
FFT Size	50 kHz: 2048 (2K FFT); 1900 Maximum active subcarriers 25 kHz: 4096 (4K FFT); 3800 Maximum active subcarriers																		
Sampling Rate	102.4 MHz																		
FFT Time Duration	40 μs (25 kHz subcarriers) 20 μs (50 kHz subcarriers)																		
Modulation Type	BPSK, QPSK, 8-QAM, 16-QAM, 32-QAM, 64-QAM, 128-QAM, 256-QAM, 512-QAM, 1024-QAM, 2048-QAM, 4096-QAM																		
Bit Loading	Variable from minislot to minislot Constant for subcarriers of the same type in the minislot Support zero valued subcarriers per profile and minislot																		
Pilot Tones	Boosted pilots are not supported in the FDX Band																		
Cyclic Prefix Options	<table border="0"> <tr> <td>Samples</td> <td>μs</td> </tr> <tr> <td>96</td> <td>0.9375</td> </tr> <tr> <td>128</td> <td>1.25</td> </tr> <tr> <td>256</td> <td>2.5</td> </tr> <tr> <td>384</td> <td>3.75</td> </tr> <tr> <td>512</td> <td>5.0</td> </tr> </table>	Samples	μs	96	0.9375	128	1.25	256	2.5	384	3.75	512	5.0						
Samples	μs																		
96	0.9375																		
128	1.25																		
256	2.5																		
384	3.75																		
512	5.0																		
Windowing Size Options	<table border="0"> <tr> <td>Samples</td> <td>μs</td> </tr> <tr> <td>0</td> <td>0</td> </tr> <tr> <td>32</td> <td>0.3125</td> </tr> <tr> <td>64</td> <td>0.625</td> </tr> <tr> <td>96</td> <td>0.9375</td> </tr> <tr> <td>128</td> <td>1.25</td> </tr> <tr> <td>160</td> <td>1.5625</td> </tr> <tr> <td>192</td> <td>1.875</td> </tr> <tr> <td>224</td> <td>2.1875</td> </tr> </table> <p>Raised cosine absorbed by CP</p>	Samples	μs	0	0	32	0.3125	64	0.625	96	0.9375	128	1.25	160	1.5625	192	1.875	224	2.1875
Samples	μs																		
0	0																		
32	0.3125																		
64	0.625																		
96	0.9375																		
128	1.25																		
160	1.5625																		
192	1.875																		
224	2.1875																		
Level	Total average output power of 64.5 dBmV																		

Parameter	Value
Output Impedance	75 ohms
Output Return Loss While in FDX Mode	> 6 dB 5 MHz to 85 MHz > 6 dB 108 MHz to 1218 MHz
Connector	F connector per [ISO/IEC-61169-24] or [SCTE 02]
Table Notes:	
Note 1. Use Case: ranging probe transmission. Value set as wide as possible for per tone pre-EQ coverage, when the taper region is the largest.	
Note 2. This is the same value as the Min Contiguous Modulated Spectrum.	

7.2.4.14 FDX CMTS Receiver Capabilities

For FDX devices operating in FDX mode, this section augments section 7.4.14 of [DOCSIS PHYv3.1] and corresponding subsections unless otherwise noted.

7.2.4.14.1 FDX CMTS Receiver Input Power Requirements

Demodulator input power characteristics are not applicable to an FDX Node as interface C is not a defined measurement interface in an FDX Node. Measurements are performed on interface D and thus demodulator input power is replaced by minimum performance requirements defined in Table 16.

7.2.4.14.2 FDX Node Receiver Error Ratio Performance in AWGN Channel

The post-FEC Packet Error Ratio (PER) performance of the OFDMA receiver at the Node is defined with reference to a PER of 10^{-6} with 1500 byte Ethernet packets. This section describes the conditions under which this packet error ratio measurement has to be made.

The FDX Node MUST NOT exceed Packet Error Ratio of 10^{-6} in any of the six FDX upstream channels when operating under downstream transmission and channel conditions described below and when Carrier-to-Noise Ratio of the channel is at or below the values shown in Table 16 - Node Minimum CNR Performance in FDX Channel.

- A single transmitter CM, pre-equalized and ranged to provide a flat power spectral density at interface D.
- Measurement on single FDX OFDMA channels with 95 MHz modulated spectrum.
- Ranging with same CNR and input level to FDX Node as with data bursts, and with 8-symbol probes.
- Any valid transmit combination (frequency, subcarrier clock frequency, transmit window, cyclic prefix, OFDMA frame length, interleaving depth, pilot patterns, etc.) as defined for the FDX Band.
- Input power level per constellation is per the set points as defined in Table 16.
- OFDMA phase noise and frequency offset are at the upper limits as defined for the CM transmission specification.
- Large grants consisting of several 1500 Byte packets.
- The CMTS is allowed to construct MAPs according to its own scheduler implementation.
- The FDX Node is transmitting over the frequency band from 108 MHz to 1218 MHz with an up-tilted spectrum as defined in the section covering Node downstream fidelity requirements.
- Using a cable network model to provide micro-reflections of the downstream transmission back to the FDX Node, as shown in Table 14. The cable network model is specified by the *s11* parameter of the cable network at FDX Node Interface D. This parameter is tabulated in [NodePortEchoResponse], as a function of frequency between 108 MHz and 684 MHz.
- The peak envelope echo return loss at interface D is not less than the return loss given in Table 14 below. Linear interpolation is applied to the table to obtain the return loss at intermediate frequencies.

Table 14 - Peak Return Loss

Frequency (MHz)	Return Loss (dB)
108	10.4
204	12.8
300	14.4
396	15.8
492	16.9
588	17.9
684	18.7
780	19.4
876	19.8

The average echo return loss in each of the six 96 MHz upstream FDX channels as well as the two 96 MHz channels above 684 MHz, at interface D, is not less than the corresponding average echo return loss obtained from the cable model, given in Table 15.

Table 15 - Average Return Loss

Frequency (MHz)	Average Return Loss (dB)
108 - 204	17.6
204 - 300	19.0
300 - 396	19.9
396 - 492	20.8
492 - 588	21.5
588 - 684	22.1
684 - 780	22.6
780 - 876	22.9

In the case of multiple cable legs from the node, only one leg is active, with other legs terminated appropriately.

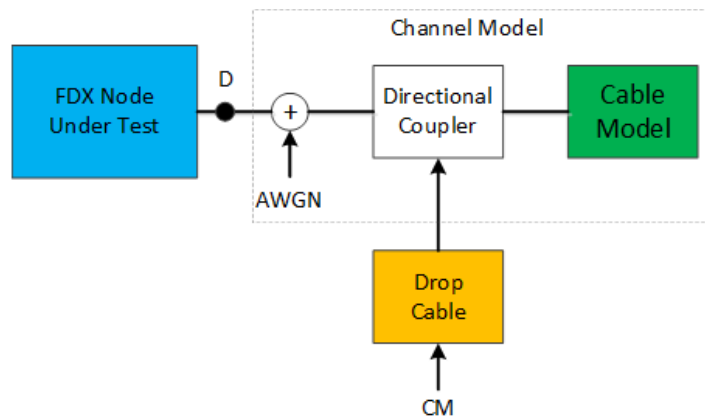

Figure 7 - Set-up for the FDX Node Packet-Error-Ratio Performance Test

The drop cable in Figure 7 connecting the CM is intended to compensate for the up-tilt in the CM output in order to provide a flat upstream power spectral density at interface D.

Figure 8 shows the Node receiving an upstream channel in the frequency range 396 MHz to 492 MHz. This is for illustration purposes only. FDX Node PER requirements apply with all six 96 MHz FDX upstream channels active and with worst case CNR conditions listed in Table 16.

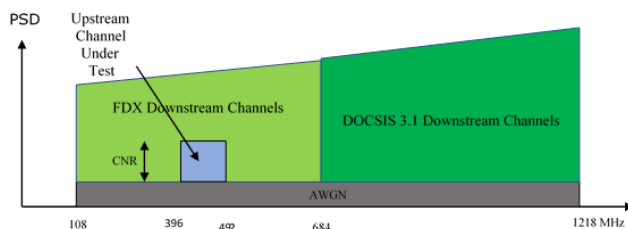

Figure 8 - Spectrum at Interface D for the Node Receiver PER Test

CNR is defined as the ratio of the received signal power to the additive white Gaussian noise power over the 95 MHz received bandwidth.

Table 16 - Node Minimum CNR Performance in FDX Channel

Constellation	CNR (dB)	Set Point Measured at Interface D (dBmV/6.4 MHz)	Offset
QPSK	12.5	0	0 dB
8-QAM	15.5	0	0 dB
16-QAM	18.5	0	0 dB
32-QAM	22.0	0	0 dB
64-QAM	25.5	0	0 dB
128-QAM	29.0	1	0 dB
256-QAM	32.0	3	0 dB
512-QAM	36.0	5	0 dB
1024-QAM	44.0	7	0 dB
2048-QAM	N/A	N/A	0 dB
4096-QAM	N/A	N/A	0 dB

Table Notes:

Note 1. CNR is defined here as the ratio of average signal power in occupied bandwidth to the average noise power in the occupied bandwidth given by the noise power spectral density integrated over the same occupied bandwidth.

Note 2. Channel CNR is adjusted to the required level by measuring the source in-band noise including phase noise component and adding the required delta noise from an external AWGN generator.

Note 3. The channel CNR requirements are for OFDMA channels with non-boosted pilots

7.2.4.15 Ranging

See [DOCSIS PHYv3.1], section 7.4.15.

7.2.4.16 Upstream Pilot Structure

See [DOCSIS PHYv3.1], section 7.4.16.

7.2.4.17 Upstream Pre-Equalization

See [DOCSIS PHYv3.1], section 7.4.17.

7.2.5 FDX Downstream Transmit and Receive

7.2.5.1 Overview

This section specifies the downstream electrical and signal processing requirements for the transmission of OFDM modulated RF signals from the CMTS to the CM.

7.2.5.2 Signal Processing

See [DOCSIS PHYv3.1], section 7.5.2.

7.2.5.3 Time and Frequency Synchronization

See [DOCSIS PHYv3.1], section 7.5.3.

7.2.5.4 Downstream Forward Error Correction

See [DOCSIS PHYv3.1], section 7.5.4.

7.2.5.5 Mapping Bits to QAM Constellations

See [DOCSIS PHYv3.1], section 7.5.5.

7.2.5.6 Interleaving and De-interleaving

See [DOCSIS PHYv3.1], section 7.5.6.

7.2.5.7 IDFT

See [DOCSIS PHYv3.1], section 7.5.7.

7.2.5.8 Cyclic Prefix and Windowing

See [DOCSIS PHYv3.1], section 7.5.8.

7.2.5.9 FDX Downstream Fidelity Requirements

For FDX devices operating in FDX mode, this section augments section 7.5.9 of [DOCSIS PHYv3.1] and corresponding subsections unless otherwise noted.

For the purposes of this specification, the number of occupied CTA channels of an OFDM channel is the occupied bandwidth of the OFDM channel divided by 6 MHz.

FDX Nodes capable of generating N -channels of legacy DOCSIS plus NOFDM-channels of OFDM per RF port, for purposes of the [DOCSIS DRFI] output electrical requirements, the device is said to be capable of generating N_{eq} -channels per RF port, where $N_{eq} = N + 32 * N_{OFDM}$ "equivalent legacy 6 MHz DOCSIS channels."

An N_{eq} -channel per RF port FDX Node MUST comply with all requirements operating with all N_{eq} channels on the RF port, and MUST comply with all requirements for an N_{eq}' -channel per RF port device operating with N_{eq}' active channels on the RF port for all values of N_{eq}' less than N_{eq} (which is at least 185) down to $N_{eq}' = 96$.

These specifications assume that the FDX Node will be terminated with a 75 Ohm load.

7.2.5.9.1 FDX Node Output Electrical Requirements

Multiple operators use a mid-split (5 MHz to 85 MHz/108MHz to 1218 MHz) spectrum arrangement in fiber deep deployments. The nominal node RF output power practiced in such deployments is 58 dBmV per 6 MHz equivalent channel at the upper edge of the DS active spectrum (6 MHz centered at 1215 MHz), and 37 dBmV per 6 MHz equivalent channel at the lower edge of the DS active spectrum (6 MHz centered at 111 MHz), forming a linear tilt of 21 dB across the active DS spectrum. This is defined as the Downstream Reference PSD.

This sums up to 73.8 dBmV total composite power, and a power slope of approximately 1.89 dB per 100 MHz. Due to the power tilt, much of this power is concentrated at the upper edge of the spectrum. For example, if a full OFDM channel is used between 1026 MHz and 1218 MHz, that channel power is 71.4 dBmV, where the power of all other channels between 108 MHz and 1026 MHz sums up to only 70.1 dBmV.

Implementation of FDX in the node is associated with more insertion loss between the hybrid power amplifier and the node port. This additional loss is mainly associated with replacement of a diplex filter with a US/DS combiner or directional coupler, and with the addition of another directional coupler required for implementation of echo cancellation. Due to the additional insertion loss, achievement of the above-mentioned node output power level is

beyond the available hybrid power amplifiers technology as of the time of drafting these specifications. The scheme outlined below is a compromise intended to reduce the total composite power at the node output to 72 dBmV or lower, while maintaining the power level and tilt seen by legacy devices (set-tops and pre-DOCSIS 3.1 modems) capable of receiving channels up to ~1 GHz. It is envisioned that when hybrid power amplifiers technology is sufficiently improved, this compromise can be annulled in a future release of these specifications.

In order to reduce the total composite output power of an FDX Node to 72 dBmV, the power level of the upper edge of the active DS spectrum is reduced. This is implemented as a single down step in the power per 6 MHz equivalent channel, while maintaining the same power slope of approximately 1.89 dB per 100 MHz across the active DS spectrum. The power level at the upper portion of the spectrum prior to applying the down step is termed virtual power, and the power level after the step is applied is termed actual power. Since different deployments are likely to use various arrangements of OFDM channels at the upper portion of the spectrum, and since a power level step cannot be implemented inside the encompassed spectrum boundaries of an OFDM channel, some flexibility is required in setting the frequency of the power down-step. Accordingly, the step size required is also variable, since it has to assure that the total composite power is at or below 72 dBmV. For example, reducing the top 192 MHz of spectrum by 4 dB achieves that goal. A more extreme example is muting the spectrum above 1122 MHz (the 16 top 6 MHz equivalent channels).

The FDX Node requirements use the defined Downstream Reference PSD with a 21 dB linear tilt between the 6 MHz equivalent channel centered at 111 MHz and the 6 MHz equivalent channel centered at 1215 MHz, where the power of the 6 MHz equivalent channel centered at 111 MHz is 37 dBmV, and the power of the 6 MHz equivalent channel centered at 1215 MHz is 58 dBmV.

The FDX Node **MUST** support a minimum TCP of 72 dBmV between 108 MHz and 1218 MHz.

The FDX Node **SHOULD** support a minimum TCP of 73.8 dBmV between 108 MHz and 1218 MHz.

The FDX Node **MUST** support setting a single power down-step at a frequency on a channel boundary between 1002 MHz and 1122 MHz at Interface D, and with a depth assuring that the maximum total composite power (a minimum of 72 dBmV) is achieved. The downstream power profile is shown in Figure 9. If the FDX Node is generating a TCP of 73.8 dBmV, then no step down is required because the needed step down is 0 dB.

If the FDX Node is operating at a TCP of 71 dBmV, then the FDX Node supports the more stringent fidelity requirements detailed in Table 18 and Table 20.

The FDX Node **MAY** support setting a single power down-step at a frequency on a channel boundary below 1002 MHz.

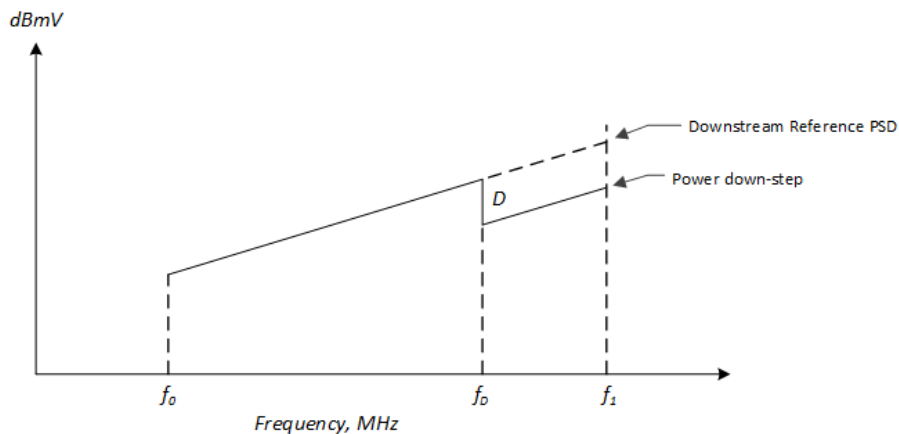

Figure 9 - Downstream Power Profile with D dB Step-down at f_0 MHz

The power per 6 MHz equivalent channel for each of the 185 channels between 108 MHz and 1218 MHz is:

$$P_i = 37 + \frac{21 \cdot (i - 1)}{184} - Step(i)$$

Where i is the index of the channel in the DS spectrum (not STD channel number), and $Step(i)$ is given by:

$$Step(i) = \begin{cases} 0, & i \leq \text{number of 6MHz equivalent channels before the down step} \\ \text{step size}, & i > \text{number of 6MHz equivalent channels before the down step} \end{cases}$$

The TCP in a band extending from f_{start} (MHz) to f_{stop} (MHz) with a D dB drop down at frequency f_D (MHz) is a virtual power setting as illustrated in Figure 10 and described above, and is given by the following formula:

$$TCP(dBmV) = 50.78412 + 10 \log_{10} \left(\frac{\left(10^{\left(\frac{f_D}{528.571}\right)} - 10^{\left(\frac{f_{start}}{528.571}\right)} \right) + 10^{-D/10} * \left(10^{\left(\frac{f_{stop}}{528.571}\right)} - 10^{\left(\frac{f_D}{528.571}\right)} \right)}{\right)}$$

The required drop down in power at to achieve a TCP of 71 dBmV and 72 dBmV is given in Table 17.

Downstream channel power measurements are made on a tilt-corrected version of the FDX Node output at Interface D. A mathematical tilt correction (calculated as linear down-tilt vs. frequency) is applied at Interface D after which downstream power measurements are made on the resultant "flat" spectrum. The output of the mathematical adjustment where power measurements are conducted is referred to as Interface D', as shown in Figure 10.

This flattening is calculated by subtracting the reference PSD and the commanded per channel attenuation from the measured PSD providing a nominal 0 dB flat spectrum.

Measuring channel power adjustment accuracy across the spectrum is calculated by subtracting the reference PSD and the commanded per channel attenuation (including both step down and additional per channel adjustment if supported by the FDX Node) from the measured PSD providing a nominal 0 dB flat spectrum.

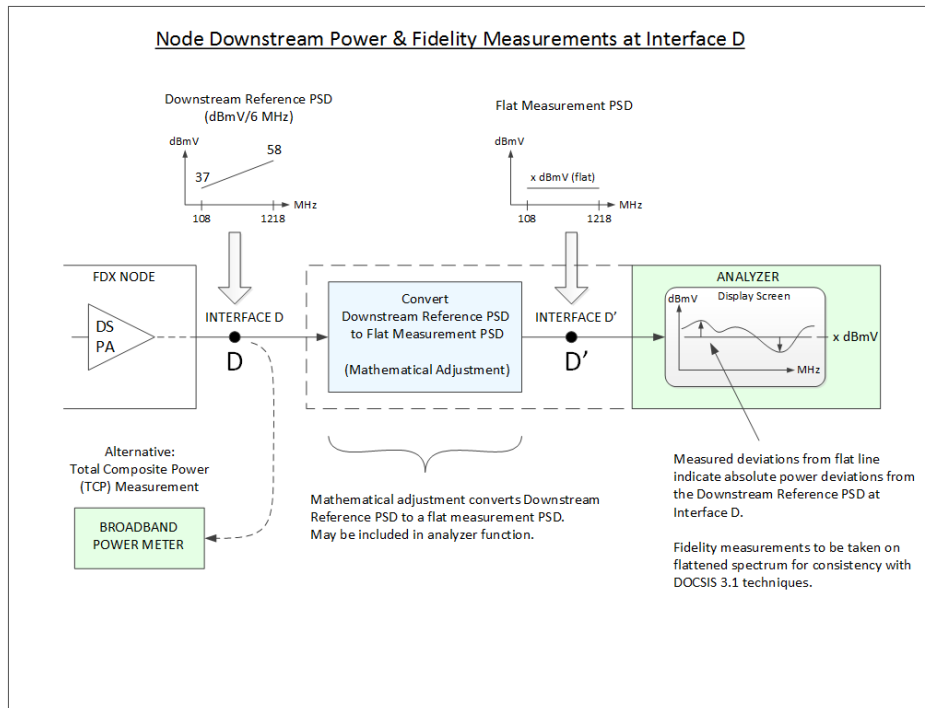

Figure 10 - FDX Node Downstream Power Measurement at Interface D

As explained above, for an FDX Node not to exceed its maximum downstream TCP limits, the node can support a single power down-step at a frequency on a channel boundary between 1002 MHz and 1122 MHz. This down step capability is not required if the FDX Node is capable of generating a TCP of at least 73.83 dBmV. The FDX Node will report its maximum downstream TCP limits to the CMTS, in addition to the stepdown limits supported.

Table 17 - Required Power Drop-down to Achieve Target TCP of 71 and 72 dBmV

Drop Frequency	Drop for 72 dBmV	Drop for 71 dBmV
1002	3.5	6.5
1008	3.6	6.7
1014	3.7	7.0
1020	3.8	7.4
1026	3.9	7.8
1032	4.1	8.2
1038	4.2	8.8
1044	4.4	9.5
1050	4.6	
1056	4.8	
1062	5	
1068	5.3	
1074	5.6	
1080	5.9	
1086	6.4	
1092	6.9	
1098	7.6	
1104	8.5	
1110	9.8	

An FDX Node MAY support individual Channel Power Adjustment, which changes each individual channel PSD to vary from the Downstream Reference PSD. A compliant FDX Node is not required to support Channel Power Adjustment, with the exception of a power step-down described previously. In this case of individual channel power adjustment capability, the channel commanded power for a channel at Interface D is, by definition, the Channel Power Adjust, and is relative to the Downstream Reference PSD. The power per channel is either 0 dB if it is on the Downstream Reference PSD or the Channel Power Adjustment value is positive if it is higher than the Downstream Reference PSD and negative if it is lower than the Downstream Reference PSD.

An FDX Node which supports individual Channel Power Adjustment will report its capability (including range) to the CMTS.

For OFDM, all modulated subcarriers in an OFDM channel are set to the same average power (except pilots which are boosted by 6 dB). For purposes of spurious emissions requirements, the "commanded transmit power per channel" for an equivalent legacy DOCSIS channel is referenced to Interface D', and is computed as follows:

- FDX Node power is configured by power per CTA channel [CTA 542] and number of occupied CTA channels for each OFDM channel.
- For each OFDM channel, the total power is Power per CTA channel + $10_{\log_{10}}$ (Number of occupied CTA channels) for that OFDM channel.
- CMTS Core calculates power for data subcarrier and pilots (using total number of non-zero valued (non-excluded) subcarriers).

- FDX Node calculates power in 6 MHz containing PLC.
- For the spurious emissions requirements, power calculated for the 6 MHz containing the PLC is the commanded average power of an equivalent DOCSIS legacy channel for that OFDM channel.

An FDX Node MUST output an OFDM RF modulated signal with the characteristics defined in Table 18 - RF Output Electrical Requirements, Table 19 - FDX Node Output Power, and Table 20 - FDX Node Output Out-of-Band Noise and Spurious Emissions Requirements.

The condition for these requirements is all N_{eq} ' combined channels, legacy DOCSIS channels and equivalent legacy DOCSIS channels, commanded to the same average power, except for the Single Channel Active Phase Noise, Diagnostic Carrier Suppression, OFDM Phase Noise, OFDM Diagnostic Suppression, and power difference requirements, and except as described for Out-of-Band Noise and Spurious Requirements.

Table 18 - RF Output Electrical Requirements

Parameter	Value
Downstream Lower Edge Band of an FDX Node	108 MHz. (See Item #1 immediately following this table.) (See Item #2 following this table.)
Downstream Upper Edge Band of an FDX Node	1218 MHz (required) (See Item #3 following this table.)
Level	See requirements detailed above in this section.
Modulation Type	See Section 7.2.4.5
OFDM channels' subcarrier spacing	25 kHz and 50 kHz
Inband Spurious, Distortion, and Noise 1110 MHz total occupied bandwidth, 6 MHz gap (Internal Excluded subcarriers) 185 equivalent 6 MHz channels. See Notes 4, 6, 10	
For measurements below 684 MHz	≤ -39 dBr Average over center 400 kHz within gap
For measurements from 684 MHz to 1002 MHz	≤ -38 dBr Average over center 400 kHz within gap
For measurements 1002 MHz to 1218 MHz	≤ -37 dBr Average over center 400 kHz within gap
For frequencies above the stepdown frequency	0.8 dB relaxation per dB step down value
MER in 1110 MHz total occupied bandwidth, 185 equivalent 6 MHz channels. See Notes 2, 4, 5, 6	
For measurements below 684 MHz	≥ 37 dB Any single subcarrier. See Notes 1 and 11 ≥ 39 dB Average over the complete OFDM channel. See Notes 1 and 11
For measurements from 684 MHz to 1002 MHz	≥ 36 dB Any single subcarrier. See Notes 1 and 11 ≥ 38 dB Average over the complete OFDM channel. See Notes 1 and 11
For measurements 1002 MHz to 1218 MHz	≥ 35 dB Any single subcarrier. See Notes 1 and 11 ≥ 37 dB Average over the complete OFDM channel. See Notes 1,9 and 11.
MER For frequencies above the stepdown frequency	0.8 dB relaxation per dB step down value
	Minimal test receiver equalization: See Note 7 2 dB relief for above requirements (e.g., MER > 39 dB becomes MER > 37 dB)

Parameter	Value
Phase Noise, double sided maximum: Fully loaded spectrum 108 MHz to 1218 MHz with 24 MHz as exclusion sub-band centered at 999 MHz, + 6 dBc CW in center of the exclusion sub-band. +6 dBc CW is relative to the Downstream Reference PSD over 6 MHz. (CW not processed via FFT) See Note 6.	1 kHz - 10 kHz: -48 dBc 10 kHz - 100 kHz: -55 dBc
Output Impedance	75 ohms
Output Return Loss (Note 3)	> 10 dB from 108 MHz to 1218 MHz
Connector	5/8-24 port, Female Adapter [SCTE 91]
Table Notes:	
Note 1. Receiver channel estimation is applied in the test receiver; test receiver does best estimation possible. Transmit windowing is applied to potentially interfering channel and selected to be sufficient to suppress cross channel interference.	
Note 2. MER (modulation error ratio) is determined by the cluster variance caused by the transmit waveform at the output of the ideal receive matched filter. MER includes all discrete spurious, noise, subcarrier leakage, clock lines, synthesizer products, distortion, and other undesired transmitter products. Phase noise up to ± 50 kHz of the subcarrier is excluded from inband specification, to separate the phase noise and inband spurious requirements as much as possible. In measuring MER, record length or carrier tracking loop bandwidth may be adjusted to exclude low frequency phase noise from the measurement. MER requirements assume measuring with a calibrated test instrument with its residual MER contribution removed.	
Note 3. Frequency ranges are edge-to-edge.	
Note 4. Phase noise up to 10 MHz offset is mitigated in test receiver processing or by test equipment (latter using hardline carrier from modulator, which requires special modulator test port and functionality).	
Note 5. Up to 5 subcarriers in one OFDM channel can be excluded from this requirement.	
Note 6. For test purposes full loading is defined as 3 OFDM channels 108 MHz to 684 MHz, 25 SC-QAM channels 684 MHz to 834 MHz, and 2 OFDM channels 834 MHz to 1218 MHz, and with the power drop necessary to achieve the total composite power requirement.	
Note 7. The estimated channel impulse response used by the test receiver is limited to half of length of smallest transmit cyclic prefix.	
Note 8. A single subcarrier in the OFDM channel can be excluded from this requirement, no windowing is applied, and minimum CP is selected.	
Note 9. This is the performance with the Downstream Reference PSD. It is not required for the FDX Node to transmit at this level. A compliant device will incorporate a power step down and the MER requirement is adjusted from Downstream Reference PSD requirement according to 0.8 dB per dB of power step down.	
Note 10. This is the minimum target in-band distortion with a downstream TCP of 72 dBmV. If the FDX Node is operating with a TCP of 71 dBmV, then 2 dB is added to each requirement value, for example -39 dB becomes -41 dB.	
Note 11. This is the minimum target MER with a downstream TCP of 72 dBmV. If the FDX Node is operating with a TCP of 71 dBmV, then 2 dB is added to each requirement value, for example 39 dB becomes 41 dB.	

7.2.5.9.1.1 Power per Channel for FDX Node

FDX Nodes perform the modulation of channels which are ordinarily generated by EQAMs and CMTSSs at the headend.

Control over an FDX Node's electrical output is required for many of the characteristics, such as RF channel power, number of RF channels, modulation characteristics of the channels, center frequency of channels, and so forth. Two distinct mechanisms of control can exist for an FDX Node. One mechanism of control is via commands carried in the downstream link into the FDX Node. A second mechanism of control is "local-only", separate from the downstream link into the FDX Node, such as an electrical interface operable at installation or even pluggable components set at installation. In an FDX Node some adjustable characteristics can be controlled by one mechanism, and not the other, or by both; therefore, some "adjustable" characteristics can perhaps not be remotely changed. Local-only adjustments made at installation can be subsequently amended, but not remotely, and could incur service interruption.

An FDX Node is capable of generating 185 equivalent legacy DOCSIS channels onto the RF port at Interface D, so $N_{eq} = 185$ for a compliant FDX Node.

An FDX Node has to be adjustable to operate with fewer than $N_{eq} = 185$ channels on its RF port, for all N_{eq}' down to $N_{eq}' = 96$ channels. The FDX Node has to comply with all requirements operating with all $N_{eq} = 185$ channels on the RF port, and has to comply with all requirements operating with N_{eq}' channels on the RF port for all values of N_{eq}' less than N_{eq} that it supports.

These specifications assume that the FDX Node will be terminated with a 75 ohm load.

The FDX Node MUST support setting $P_{TCP_actual}(0)$, the measured TCP at the node output immediately after the last configuration change, in the range of 70 dBmV to 72 dBmV, for 1110 MHz of modulated spectrum.

The FDX Node MUST accept a sufficiently large range of P_{TCP_config} , the configuration parameter for the FDX Node TCP, to ensure that $P_{TCP_actual}(0)$ can be set over the 70 dBmV to 72 dBmV required range, even at the worst case actual absolute power inaccuracy of the FDX Node. For example, with -2.5 dB absolute accuracy, P_{TCP_config} will be 74.5 dBmV to achieve $P_{TCP_actual}(0)$ of 72 dBmV.

The FDX Node MUST comply with the fidelity spec Table 19 - FDX Node Output Power, when $P_{TCP_actual}(0)$ is in the range of 70 dBmV to 72 dBmV. The FDX Node does not need to comply with the fidelity spec when $P_{TCP_actual}(0)$ is outside the range of 70 dBmV to 72 dBmV. If $P_{TCP_actual}(0)$ is within the range of 70 dBmV to 71 dBmV, the FDX Node is expected to meet the requirements associated with 71 dBmV TCP. If $P_{TCP_actual}(0)$ is within the range of >71 dBmV to 72 dBmV, the FDX Node is expected to meet the requirements associated with 72 dBmV TCP.

The FDX Node MUST maintain power stability (over time and its specified operating temperature range) such that

$$|P_{TCP_actual}(t) - P_{TCP_actual}(0)| \leq 1 \text{ dB}$$

where, $P_{TCP_actual}(t)$ is the measured TCP at the node output any time after $P_{TCP_actual}(0)$ was last set.

Note that the fidelity spec has to be met according to $P_{TCP_actual}(0)$ and not $P_{TCP_actual}(t)$.

Note: When the modulated spectrum is less than 1110 MHz, the TCP will drop but the power spectral density of the active channels is expected to remain within the above specified limits.

Note: The above requirements apply to slow variations on the FDX Node TCP.

Table 19 - FDX Node Output Power

For N_{eq}' (number of active channels combined per RF port) in the range 96 to 185	
Parameter	Value
Power difference between any two adjacent 6 MHz equivalent channels in the 108 MHz to 1218 MHz downstream spectrum (with commanded tilt mathematically removed and accounting for pilot density variation and subcarrier exclusions)	≤ 0.5 dB
Power difference between any two non-adjacent 6 MHz equivalent channels in a 48 MHz contiguous bandwidth block (with commanded tilt mathematically removed and accounting for pilot density variation and subcarrier exclusions)	≤ 1 dB
Power difference between any two 6 MHz equivalent channels in the 108 MHz to 1218 MHz downstream spectrum (with commanded tilt mathematically removed and accounting for pilot density variation and subcarrier exclusions)	≤ 2 dB
Power per channel absolute accuracy	± 3 dB at 25°C
RF output composite power stability	± 1 dB over time and temperature relative to time immediately after last configuration change.
Power per channel stability	± 1 dB over time and temperature relative to RF output composite power.
Single Channel Suppression	Channel suppression within the occupied bandwidth The FDX Node is required to control transmissions such that when it suppresses a channel the FDX Node output complies with the spurious emissions and noise requirements in the gap formed by suppressing the channel, as specified in Table 18. No service interruption or detriment

7.2.5.9.1.2 Out-of-Band Noise and Spurious Requirements for FDX Node

In [DOCSIS DRFI] and [DOCSIS PHYv3.1], the targeted system architectures allowed other downstream signals to be combined or added to the compliant downstream modulator's output (now referenced as Interface C). As a result, there were stringent requirements for out-of-band spurious emissions so that the compliant downstream modulator's signal will combine with other signals and provide suitable signal-to-noise ratio in the spectrum containing the combined signals. With the FDX Node downstream modulator the requirements are referenced to Interface D (or Interface D'), and at this port all downstream signals are present and there is no subsequent combining, so there is less need for the out-of-band spurious requirements that exist for the CMTS and the remote node Interface C.

However, there are still requirements for spurious emissions for spectrum besides the downstream spectrum, such as transition bands and legacy upstream spectrum. Also, there are still requirements for spurious emissions in downstream spectrum that is suppressed, and exclusion sub-bands and gaps in the encompassed spectrum cannot have unconstrained spurious emissions. These requirements are much simpler in form than the [DOCSIS DRFI] and [DOCSIS PHYv3.1] spurious emissions requirements because N_{eq} is a fixed number for the FDX Node downstream modulator.

In [DOCSIS DRFI] and [DOCSIS PHYv3.1], as the amount of modulated spectrum is increased in the compliant device, the spurious emissions requirements allow more power within a given measurement bandwidth (relative to the signal power spectral density). This is not the case for the FDX Node requirements. Also, unlike the FDX Node downstream requirements, the signal PSD for DRFI and DOCSISv3.1 is applied with a flat modulated PSD, while the FDX Node generates a 21 dB up tilt (when operating with the maximum modulated spectrum, 108 MHz to 1218 MHz). The Interface D output incorporates a significant power amplifier which is not incorporated in the Interface C requirements of the earlier requirements ([DOCSIS DRFI] and [DOCSIS PHYv3.1]). For these reasons, the FDX Node Interface D fidelity requirements are not as high fidelity as for the earlier DOCSIS downstream modulators.

The out-of-band spurious emissions requirements at Interface C have served as a rough reference and bound (of sorts) for MER performance; there are additional contributors to MER, but on the other hand, performance can be better than the requirement, so the out-of-band spurious emissions requirements are not a rigorous bound for MER. Since out-of-band spurious emissions requirements include a distortion contribution, spurious emissions relaxation is provided in gaps within modulated spectrum for measurements in gaps below 684 MHz. For measurements above 684 MHz there is no additional relaxation for gaps; the relaxation provided for higher frequency (above 684 MHz) is already generous.

With the aforementioned listed considerations, it is informative to review the "protection" for digital signals from DRFI and DOCSIS 3.1 downstream modulators provided at Interface C with the modulated spectrum of 108 MHz to 1218 MHz (185 equivalent legacy SC-QAM DOCSIS channels), and with 960 MHz modulated spectrum (160 equivalent legacy SC-QAM DOCSIS channels). Also note that some of the DOCSIS 3.1 downstream modulator fidelity requirements specify 576 MHz modulated spectrum (96 equivalent DOCSIS channels).

With all digital channels at the same equivalent power per 6 MHz channel at Interface C, the [DOCSIS DRFI] and [DOCSIS PHYv3.1] spurious emissions specifications provide for 51 dB SNR protection for digital channels below 600 MHz with transmissions of 960 MHz modulated spectrum (160 equivalent legacy DOCSIS channels). With the additional 1 dB relaxation within a gap, 50 dB SNR protection is provided below 600 MHz in a gap within the downstream modulated spectrum. The SNR protection is 48 dB between 600 MHz and 1002 MHz for digital channels operating with 960 MHz occupied bandwidth, or in a gap within the encompassed spectrum within that frequency range, generated by a DOCSIS 3.1-compliant device. The SNR protection is 46 dB between 1002 MHz and 1218 MHz for digital channels operating with 960 MHz occupied bandwidth, or in a gap within the encompassed spectrum within that frequency range, generated by a DOCSIS 3.1-compliant device.

There is an additional 0.63 dB lower SNR when the modulated spectrum corresponds to 185 equivalent legacy SC-QAM DOCSIS channels, instead of 160, in [DOCSIS DRFI] and [DOCSIS PHYv3.1].

With all digital channels at the same equivalent power per 6 MHz channel at Interface C, the [DOCSIS DRFI] and [DOCSIS PHYv3.1] spurious emissions specifications provide for 50 dB SNR protection for digital channels below 600 MHz with transmissions of 1110 MHz modulated spectrum (185 equivalent legacy DOCSIS channels). With the additional 1 dB relaxation within a gap, 49 dB SNR protection is provided below 600 MHz in a gap within the downstream modulated spectrum. The SNR protection is 47 dB between 600 MHz and 1002 MHz for digital channels operating with 1110 MHz occupied bandwidth, or in a gap within the encompassed spectrum

within that frequency range, generated by a DOCSIS 3.1-compliant device. The SNR protection is 45 dB between 1002 MHz and 1218 MHz for digital channels operating with 1110 MHz occupied bandwidth, or in a gap within the encompassed spectrum within that frequency range, generated by a DOCSIS 3.1-compliant device.

With all digital channels at the same equivalent power per 6 MHz channel at Interface C, the [DOCSIS DRFI] and [DOCSIS PHYv3.1] spurious emissions specifications provide for 53 dB SNR protection for digital channels below 600 MHz with transmissions of 576 MHz modulated spectrum (96 equivalent legacy DOCSIS channels). With the additional 1 dB relaxation within a gap, 52 dB SNR protection is provided below 600 MHz in a gap within the downstream modulated spectrum. The SNR protection is 50 dB between 600 MHz and 1002 MHz for digital channels operating with 576 MHz occupied bandwidth, or in a gap within the encompassed spectrum within that frequency range, generated by a DOCSIS 3.1 compliant device. The SNR protection is 48 dB between 1002 MHz and 1218 MHz for digital channels operating with 576 MHz occupied bandwidth, or in a gap within the encompassed spectrum within that frequency range, generated by a DOCSIS 3.1 compliant device.

The In-band Spurious, Distortion, and Noise requirements specified in Section 7.2.5.9.1 (at Interface C or equivalent), with 96 equivalent legacy SC-QAM DOCSIS channels for modulated spectrum (576 MHz) has requirements for 50 dBr, 47 dBr, and 45 dBr, for the three frequency bands, which corresponds to 2 dB and 3 dB and 3 dB reduction from the spurious emissions requirements in the same bands, respectively, within a gap. With the same margins applied to the spurious emissions requirements with 185 equivalent legacy SC-QAM DOCSIS channels, the In-band Spurious, Distortion, and Noise requirements at Interface C would become 47 dBr, 44 dBr, and 43 dBr, respectively.

For the FDX Node downstream modulator, the requirements allow reduced fidelity compared to Interface C of previous specifications, for reasons cited above. For the 72 dBmV (71 dBmV) TCP the following remarks apply regarding the SNR "protection" for digital channels. As observed at Interface D' (which corresponds to 185 equivalent DOCSIS channels of modulated spectrum, or less), the SNR "protection" for digital channels below 684 MHz, within a gap, is 39 dB (41 dB) (it is 49 dB at Interface C in DOCSIS 3.1 below 600 MHz); for digital channels between 684 MHz and 1002 MHz, within a gap, is 38 dB (40 dB) (it is 47 dB at Interface C in DOCSIS 3.1 from 600 MHz to 1002 MHz); for digital channels between 1002 MHz and 1218 MHz, within a gap, is 37 dB (39 dB) (it is 45 dB at Interface C in DOCSIS 3.1 between 1002 MHz and 1218 MHz). The In-band Spurious, Distortion, and Noise requirements at Interface D' are 39 dB (41 dB), 38 dB (40 dB), and 37 dB (39 dB) in the respective frequency bands (below 684 MHz; between 684 MHz and 1002 MHz; and between 1002 MHz and 1218 MHz).

Table 20 - FDX Node Output Out-of-Band Noise and Spurious Emissions Requirements

For N_{eq} (number of active channels combined per RF port) in the range 96 to 185	
Condition	Requirement (in dBr)
1110 MHz total occupied bandwidth down to 576 MHz total occupied bandwidth, 6 MHz measurement interval outside modulated spectrum See Note 1	
For measurements below 684 MHz	≤ -39 dBr Average over 6 MHz, 72 dBmV TCP ≤ -41 dBr Average over 6 MHz, 71 dBmV TCP
For measurements from 684 MHz to 1002 MHz	≤ -38 dBr Average over 6 MHz, 72 dBmV TCP ≤ -40 dBr Average over 6 MHz, 71 dBmV TCP
For measurements from 1002 MHz to 1218 MHz	≤ -37 dBr Average over 6 MHz, 72 dBmV TCP ≤ -39 dBr Average over 6 MHz, 71 dBmV TCP
For frequencies above the stepdown frequency	0.8 dB relaxation per dB step down value
	For frequencies between channels with different PSD the zero dBr reference is the channel with the highest PSD.

Table Note

Note 1. Loading is defined as 3 OFDM channels 108 MHz to 684 MHz, 25 SC-QAM channels 684 MHz to 834 MHz, and 2 OFDM channels 834 MHz to 1218 MHz, and with the power drop necessary to achieve the total composite power requirement; and any number and combination of reduced modulated spectrum down to 576 MHz modulated spectrum. Different types of channels and locations of channels can also be tested and meet the requirements, as long as the gap ratio requirements are satisfied.

7.2.5.10 Independence of Individual FDX Channels Within Multiple Channels on a Single RF Port

For FDX devices operating in FDX mode, this section augments section 7.5.10 of [DOCSIS PHYv3.1] and corresponding subsections unless otherwise noted.

The CMTS output OFDM channel characteristics are collected in section 7.5.10 of [DOCSIS PHYv3.1]. The CMTS requirements in section 7.5.10 of [DOCSIS PHYv3.1] apply to the FDX Node with the exception of the following:

- The FDX Node MUST support 86 MHz Minimum Contiguous Modulated OFDM Bandwidth per channel in the Full Duplex Band.
- An FDX Node MUST provide for 1 mode of carrier suppression of RF power for diagnostic and test purposes. See Table 19 for mode descriptions and carrier RF power suppression level instead of table 42 as referenced in item 2 and item 7 in section 7.5.10 of [DOCSIS PHYv3.1].
- Instead of item 4 in [DOCSIS PHYv3.1], section 7.5.10, an FDX Node MUST provide the ratio of amount of modulated spectrum to gap spectrum in the encompassed spectrum between 108 MHz and 1218 MHz being at least 2:1, and with each channel independently meeting the DOCSIS 3.1 requirements in Section 7.2.5.9.1, and requirements for DRFI in Section 6.3.5, except for fidelity requirements.
- Instead of item 4 in [DOCSIS PHYv3.1], section 7.5.10, an FDX Node MUST meet the requirements in Section 7.2.5.9.1, and requirements for DRFI in Section 6.3.5, when the ratio amount of modulated spectrum to gap spectrum in the encompassed spectrum is at least 4:1. (A ratio of amount of modulated spectrum to gap spectrum of at least 4:1 provides that at least 80% of the encompassed spectrum contains modulated spectrum, and the amount of gap spectrum is at most 20% of the encompassed spectrum.)

Instead of item 6 in [DOCSIS PHYv3.1], section 7.5.10, an FDX Node MUST provide a test mode of operation, for out of service testing, configured for 1076 MHz of modulated spectrum (i.e., 1100 MHz with a 24 MHz gap in an OFDM channel centered on approximately 900 MHz plus a CW tone as described here). Centered within the 24 MHz gap there is a CW tone which is 6 dB higher power than the power in 6 MHz of the downstream modulated spectrum at the Downstream Reference PSD, as measured at Interface D'. An FDX Node generation of the CW test tone SHOULD exercise the signal generation chain to the fullest extent practicable, in such manner as to exhibit phase noise characteristics typical of actual operational performance. One purpose of this test mode is to support one method for testing the phase noise requirements of Table 18.

7.2.5.11 FDX Cable Modem Receiver Input Requirements

For FDX devices operating in FDX mode, this section augments section 7.5.11 of [DOCSIS PHYv3.1] and corresponding subsections unless otherwise noted.

The FDX CM MUST be able to accept any range of OFDM subcarriers defined between Lower Frequency Boundary and Upper Frequency Boundary simultaneously.

Active subcarrier frequencies, loading, and other OFDM characteristics are described by OFDM configuration settings and CM exclusion bands and profile definition. The OFDM signals and CM interfaces will have the characteristics and limitations defined in Table 21.

The FDX CM MUST support the requirements in Table 21 - Electrical Input to FDX CM, which supersede the corresponding requirements in [DOCSIS PHYv3.1], table 45 - Electrical Input to CM, unless otherwise noted.

Table 21 - Electrical Input to FDX CM

Parameter	Value
Lower Band Edge	108 MHz
Number of FFT Blocks	Refer to Table 7

7.2.5.12 FDX Cable Modem Receiver Capabilities

For FDX devices operating in FDX mode, this section augments section 7.5.12 of [DOCSIS PHYv3.1] and corresponding subsections unless otherwise noted.

Acceptable downstream performance for a cable modem is defined with respect to a packet error ratio (PER) of 10^{-6} . A packet is taken as a 1500-byte Ethernet packet. To satisfy the downstream PER performance requirement, the FDX CM MUST achieve a PER of 10^{-6} for CNR values not exceeding those given by Table 22 - CNR Performance Requirement of an FDX CM for External-ACI Test and Table 23 - CNR Performance Requirement of FDX CM for Self ACI Test for the tests described below.

External-ACI Test: This corresponds to the case in which the CM under test is receiving an FDX channel but not transmitting upstream in the FDX band. Other CMs in the IG are transmitting upstream in other FDX channels. CMs in other IGs are also transmitting upstream in the FDX band under test. The purpose of this is to test the CM performance under time varying ACI, CCI and ALI (Adjacent Leakage Interference).

Self-ACI Test: This is designed to test the echo cancellation performance of the FDX CM. This corresponds to the case in which CM under test is receiving in one FDX channel while transmitting upstream in the other two FDX channels.

Above FDX Transition Band Test: This corresponds to the case in which the CM under test is receiving an OFDM channel that is not located in the FDX band or in the FDX transition band.

7.2.5.12.1 Conditions Common to Both ACI Tests

This subsection defines the conditions that are common to both previously mentioned tests.

- CMTS downstream transmission for the channel under test will be an FDX band with a modulated spectrum of 190 MHz.
- Although the central FDX channel is shown as the channel under test in Figure 12 and Figure 13, tests have to be performed for all three FDX channels and the worst case CNR that gives a PER of 10^{-6} has to be used to validate the performance requirement.
- This transmission will consist of any valid combination of the following downstream parameters: subcarrier spacing, cyclic prefix size, transmitter window, PLC location, number of profiles, codeword size, NCP QAM constellation (but the QAM constellation of the NCP will not be greater than the QAM constellation used by the data subcarriers).
- The objective of the test is to identify the lowest CNR value that gives a PER of 10^{-6} for every valid QAM constellation for every combination of the previous parameters, and to compare this with corresponding entry in Table 22 and Table 23.
- Depth of time interleaving will be set to 12 for 50 kHz subcarrier spacing and 6 for 25 kHz subcarrier spacing.
- Power spectral density of the downstream transmission, measured as the power at CM input per 6 MHz (P_{6AVG}), will be set to 0 dBmV per 6 MHz over the modulated spectrum of the channel under test. The Self-ACI test includes a second case in which P_{6AVG} is set to 3 dBmV per 6 MHz.
- Downstream spectrum within and outside the FDX band, i.e., from 108 MHz to 1218 MHz, will be fully loaded with FDX and DOCSIS 3.1 channels with the same power spectral density as the FDX channel under test.
- Test modulator (FDX Signal Generator in Figure 11) phase noise per CMTS downstream modulator spec (not the FDX Node modulator spec).

- The performance will be measured in the steady state mode, i.e., with a static RBA, after channel acquisition and after echo canceller training.

7.2.5.12.2 External ACI Test

The test set-up for the external ACI test is illustrated in Figure 11.

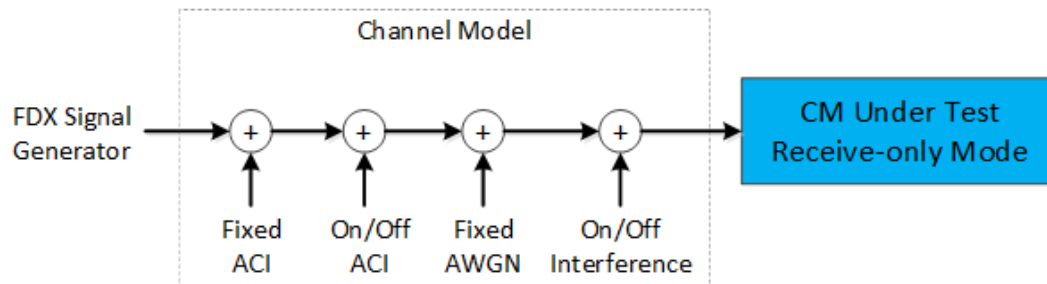

Figure 11 - Test Set-up for External ACI Test

The channel model for this test consists of the following.

- Fixed-ACI:** This corresponds to the downstream signal, FDX as well as non-FDX, and has the same power spectral density as the OFDM signal in the channel under test. This is made up of FDX and DOCSIS 3.1 OFDM downstream channels.
- On/Off ACI:** This corresponds to upstream transmissions of other CMs in same IG as the CM under test. (Note that the CM under test is not transmitting upstream in this test.) These will be in the two FDX channels other than the FDX channel under test. This ACI may be introduced in the test set-up using either FDX or DOCSIS 3.1 OFDM channels.
- The linearly up-tilted PSD of on/off ACI (during on-state) has a value of 4 dBmV/6 MHz at 108 MHz and a value of 10 dBmV/6 MHz at 684 MHz.
- Fixed AWGN:** This is the background noise level. The term "fixed" implies that it is not time-varying during the course of a test. However, the level of this is to be varied from test to test until a PER of 10^{-6} is obtained. Channel CNR is adjusted to the required level by measuring the source in-band noise including phase noise component along with transmitter noise and distortion and adding the required delta noise from an external AWGN generator to achieve the desired CNR at the CM F-connector. Let this AWGN level be defined as AWGN0 dBmV per 6 MHz. Since the signal power has been defined as 0 dBmV per 6 MHz, CNR is equal to -AWGN0. This CNR is the parameter under test (see Figure 11).
- On/off Interference:** This corresponds to the combination of ALI from upstream transmissions in adjacent channels in the same IG as well as CCI from upstream transmissions in other IGs. The level of this is -44 dBmV per 6 MHz during the on-state.
 - The channel will be periodically switched between state 0 and state 1, shown in Figure 12 and Figure 13, and as shown in Figure 15. It may be noted that ACI and AWGN are switched on and off at the same time.
 - State 0 corresponds to the situation in which on/off ACI and on/off Interference are in the off state. State 1 corresponds to the situation in which on/off ACI and on/off Interference are in the on state. AWGN1 of Figure 13 is the additive combination of the AWGN and the interference.

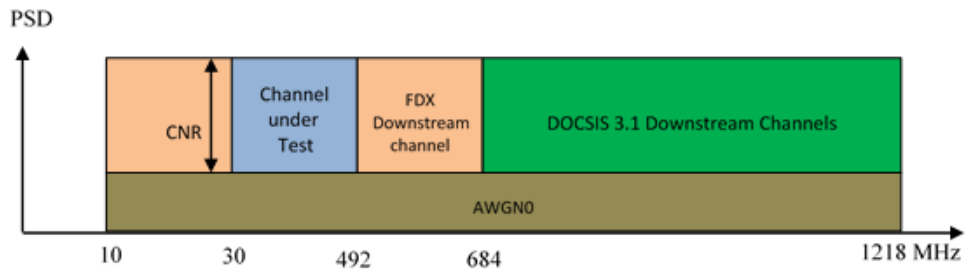

Figure 12 - State 0 for the External ACI Test

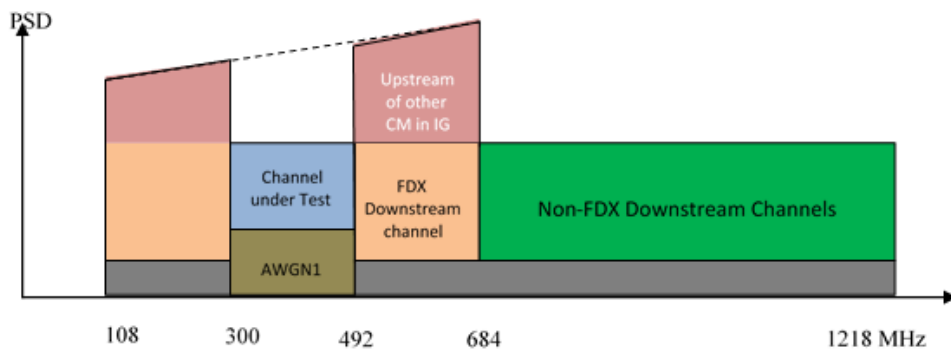

Figure 13 - State 1 for the External ACI Test

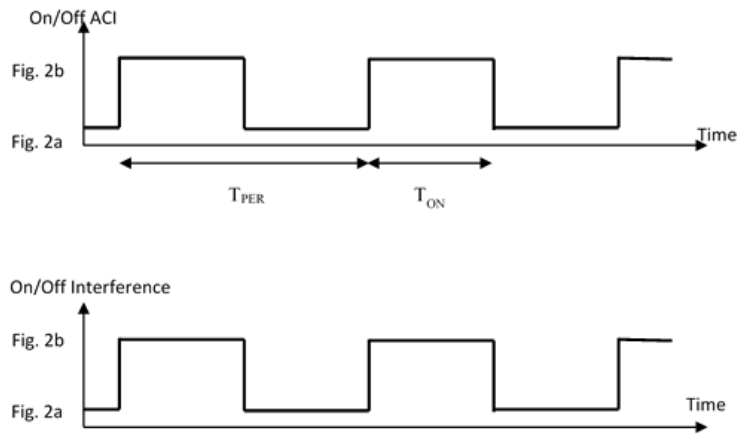

Figure 14 - Time-varying ACI and AWGN for External ACI Test

The CNR requirements to achieve a PER of 10^{-6} for all valid QAM constellations are given in Table 22.

Table 22 - CNR Performance Requirement of an FDX CM for External-ACI Test

Constellation	CNR (dB)
4096	NA
2048	40
1024	35
512	31.5
256	28.5
128	25.5
64	22.5
16	16.5

7.2.5.12.3 Self ACI Test

The test set-up for the Self ACI test is illustrated in Figure 15.

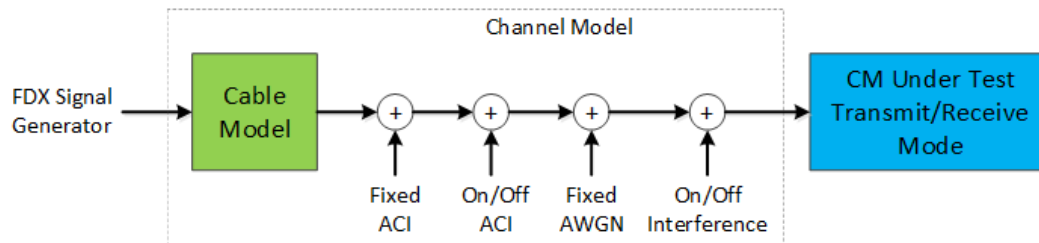

Figure 15 - Test Set-up for Self ACI Test

- The only difference between the channel model of Figure 15 and that of the External-ACI test is the inclusion of a cable model. The purpose of this is to introduce micro-reflections to the signal transmitted upstream by the CM under test.
- This cable model consists of a tap with 75 to 150 feet length of Series 6 cable from tap to a ground block compliant with SCTE 129, followed by up to 10 feet of Series 6 cable to the CM providing a combined return loss of 25 dB across 108 MHz to 684 MHz.
- The signal from the FDX signal generator will be up-tilted such that the PSD of the downstream signal at the CM input is flat and is equal in value to 0 dBmV per 6 MHz and 3 dBmV per 6 MHz for the two tests. The two tests are described later.
- The CM under test is:
 - Receiving in the FDX sub-band under test
 - Transmitting in the other two FDX sub-bands
- The remaining channel model for this test consists of the following.
 - Fixed-ACI: This corresponds to the downstream signal, FDX as well as non-FDX, and has the same power spectral density as the OFDM signal in channel under test. This is made up of FDX and DOCSIS 3.1 OFDM downstream channels.
 - On/Off ACI: This corresponds to upstream transmissions of CM in other IGs. Therefore, this is significantly weaker than on/off ACI in the external-ACI test and hence can be ignored in this test.
 - Fixed AWGN: Set AWGN0 for the background noise level for a desired CNR as in Figure 12. This is the background noise level. The term "fixed" implies that it is not time-varying during the course of a test. However, the level of this is to be varied from test to test until a PER of 10^{-6} is obtained. Let this AWGN level be defined as AWGN0 dBmV per 6 MHz. If the signal power has

been set to 0 dBmV per 6 MHz, CNR is equal to -AWGN0. If the signal power is set to 3 dBmV per 6 MHz, CNR is equal to 3-AWGN0. This CNR is the parameter under test.

- On-off Interference: This corresponds to upstream transmissions of CMs in other IGs. The level of this is defined as -44 dBmV per 6 MHz.
- In addition, there will be the self-ACI generated by the CM under test. This will also be turning on and off with the same period and with the same mark-to-space ratio as external on/off ACI and external on/off interference. However, self-ACI switching times need not be synchronized with the switching times of external on/off ACI and interference.

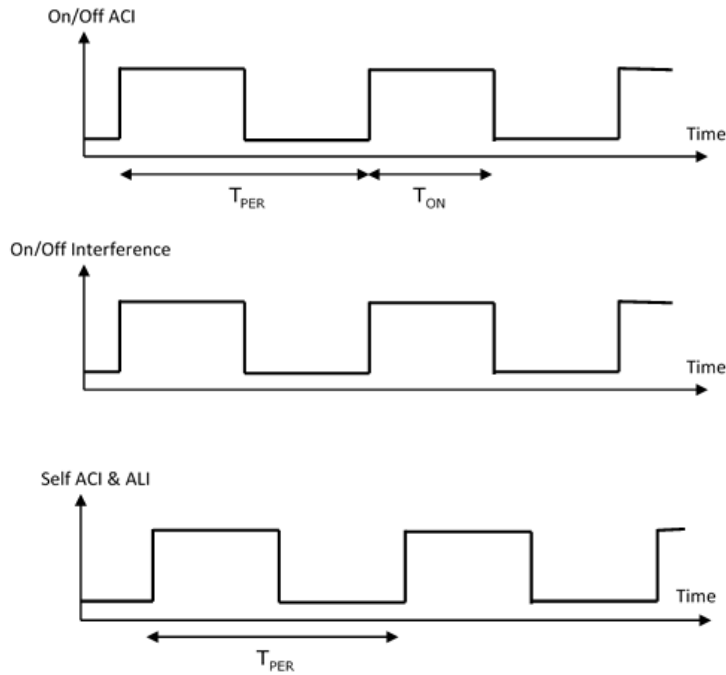

Figure 16 - Time-varying ACI and AWGN for Self ACI Test

The CNR requirements to achieve a PER of 10^{-6} for all valid QAM constellations are given in Table 23.

Table 23 - CNR Performance Requirement of FDX CM for Self ACI Test

Constellation	CNR (dB) for 0 dBmV/6 MHz input PSD and 64.5 dBmV output TCP	CNR (dB) for 3 dBmV/6 MHz input PSD and 63 dBmV output TCP
4096	N/A	N/A
2048	N/A	44.5
1024	42	36
512	33	32
256	29	29
128	26	25.5
64	23	23
16	17	17

7.2.5.12.4 Period and Mark-to-Space Ratio

Each of the previous two tests has to be implemented for nine combinations of TPER and TON as given by Table 24. This table defines three periods - 10, 70, and 200 ms - and mark-to-space ratios - 10%, 50%, and 90% - for each period.

Table 24 - TPER and TON for the Two Sets of Tests

Test	T _{PER} (ms)	T _{ON} (ms)
1	10	1
2	10	5
3	10	9
4	70	7
5	70	35
6	70	63
7	200	20
8	200	100
9	200	180

Each of the two tests, therefore, is to be done nine times for each QAM constellation. The highest CNR value of these nine tests are not to exceed that listed for the corresponding QAM constellation types in Figure 16 or Table 24.

7.2.5.12.5 Above FDX Transition Band Test

Testing for the band above the FDX transition band assumes the same test and conditions as section 7.5.12.1 of [DOCSIS PHYv3.1] with the following exceptions:

- Channel under test frequency is entirely located above the FDX transition band
- Fully loaded spectrum is defined as 108 MHz to 1218 MHz with a mix of FDX OFDM channels, SC-QAM channels and non-FDX OFDM channels
- No analog channels
- DS PSD at the CM is flat across the spectrum
- Table 25 updates the column headings and frequency ranges of table 46 of [DOCSIS PHYv3.1].

Table 25 - FDX CM in FDX Mode Minimum CNR Performance in AWGN Channel

Constellation	CNR ^{1,2} (dB)		Min P _{6AVG} dBmV
	804 MHz to 1002 MHz	1002 MHz to 1218 MHz	
4096	41.0	41.5	-6
2048	37.0	37.5	-9
1024	34.0	34.0	-12
512	30.5	30.5	-12
256	27.0	27.0	-15
128	24.0	24.0	-15
64	21.0	21.0	-15
16	15.0	15.0	-15

Table Notes:

Note 1. CNR is defined here as total signal power in occupied bandwidth divided by total noise in occupied bandwidth.

Note 2. Channel CNR is adjusted to the required level by measuring the source inband noise including phase noise component along with transmitter noise and distortion and adding the required delta noise from an external AWGN generator to achieve the desired CNR at the CM F-connector.

Note 3. Applicable to an OFDM channel with 192 MHz of occupied bandwidth.

7.2.5.13 Physical Layer Link Channel (PLC)

See [DOCSIS PHYv3.1], section 7.5.13.

7.2.5.14 Next Codeword Pointer

See [DOCSIS PHYv3.1], section 7.5.14.

7.2.6 Sounding

Channel sounding is required to assign cable modems (CMs) to Interference Groups. This is achieved by making a set of CMs (referred to in this section as the Test CMs) transmit upstream signals and making other CMs in the network (referred to as Measurer CMs) measure MER of subcarriers.

There are two sounding methods:

1. OUDP Method
2. CW Tone (CWT) Method

In the OUDP method the Test CMs may be FDX-L or FDX, but the Measurer CMs have to be FDX CM. The transmitted signals are made up of sequences of OFDMA frames occupying the modulated bandwidth of the upstream FDX channel. The Measurer CMs measure the MER of all the subcarriers covered by the OFDMA frames.

In the CWT method, the Test CMs have to be FDX, but the Measurer CMs can be either FDX-L or FDX CMs. The transmitted signals consist of a sequences CW tones. The receiving CMs measure the MER at subcarrier frequencies corresponding to the CWTs.

An FDX CM can transmit or receive on any FDX DS/US channel, while an FDX-L CM can only transmit on the FDX US channels that are below the upstream upper band edge of the CM's diplexer and receive on the DS FDX channels that are above the downstream lower band edge CM's downstream diplexer. For example, a high-split FDX-L CM can be a Test CM in the FDX spectrum between 108 MHz and 204 MHz, and a Measurer CM in the FDX spectrum above 258 MHz; a mid-split FDX-L CM can only be a Measurer CM in the FDX band, as its upstream frequency range is below 108 MHz.

The choice of the channel sounding methods for different combinations of Test and Measurer CMs are given by Table 26.

Table 26 - Channel Sounding Methods for Test-Measurer CM Combinations

Test CM	Measurer CM	Sounding Method
FDX	FDX	OUDP or CWT
FDX	FDX-L	CWT
FDX-L	FDX	OUDP

FDX CMs MUST be designed to enable implementing both OUDP and CWT methods. Therefore, any of the two methods may be used when both Test CMs and Measurer CMs are FDX CMs.

Since FDX-L CMs cannot transmit a multiplicity of CWTs, OUDP method is to be used when the FDX-L CMs are required to operate as Test CMs. Since FDX-L CMs are not designed to measure MER from OUDP frames, CWT method has to be used for an FDX-L CM operating as a Measurer CM. The sequence of operations in a typical sounding operation to identify the IG of a new CM is described in [DOCSIS MULPIv4.0].

7.2.6.1 OUDP Method

The OUDP sounding uses OUDP Test Bursts as the test signal for sounding when the measurer CMs involve only FDX CMs. However, both FDX CMs and FDX-L CMs may operate as test CMs. In this method, the Test CM MUST transmit a set of successive OFDMA frames carrying pseudo-random data over the modulated bandwidth of an upstream channel. The Measurer CMs MUST report the MER of each subcarrier in this sub-band. It is preferable to simultaneously sound all upstream channels covering a downstream channel, because sounding over one upstream channel interferes with the whole of the downstream channel that overlaps with this upstream channel.

The specification states that the FFT and CP size of FDX upstream and downstream channels sharing the same frequency band are to be the same. However, there is no requirement for the Test CM to synchronize these upstream OFDMA symbols to the downstream OFDM symbols.

Profile and OCD (OFDM Channel Descriptor) changes are not required for OUDP sounding. Furthermore, sounding can be carried out over all subcarriers, including PLC and all pilots. Note that PLC and continuous pilots are excluded from sounding in the CWT method.

Sounding can result in many uncorrectable codewords. Therefore, the Measurer CM does not update any counter that is related to PNM error ratio monitoring during the OUDP Measuring Period while DS is protected (see [DOCSIS MULPIv4.0] specification for more details).

7.2.6.1.1 Sounding Period

Refer to Section 7.2.8.

7.2.6.1.2 Upstream Transmit Power

The FDX CMTS MUST command the upstream power level based upon ranging power for the FDX CM to use during OUDP Sounding.

7.2.6.1.3 MER Measurement Procedure

Refer to Section 7.2.8.

7.2.6.2 CW Tone Method

In this procedure, the Transmitting FDX CMs send a set of CW tones as the test signal. The Measurer CMs, namely FDX-L and FDX CMs, measure the MER values at the subcarrier frequencies corresponding to these tones.

7.2.6.2.1 Frequency Offset

The CW tones cannot be placed precisely at subcarrier frequencies of the downstream transmission for reasons given below. If a CW tone is placed at a subcarrier frequency, an FDX-L CM will detect the same amplitude and phase for this tone, at subcarriers that are 128 symbols apart. Note that FDX-L CMs measure the MER of subcarriers using the mean and variance of scattered pilots, which are 128 symbols apart; the mean is the channel frequency response and variance is the noise power. Hence the CW tone at a precise subcarrier frequency will contribute only to the mean, i.e., the channel frequency response, and not to the variance, i.e., interference power. As a result, the MER measurement will be incorrect. In order to make the MER a measure of the interference caused by CW tones, these tones have to contribute to the variance and not to the mean.

A simple way of achieving this is by offsetting the frequencies of the CW tones by a small amount from the OFDM subcarrier frequencies. Let this frequency offset be $\alpha\Delta f$, where Δf is the subcarrier spacing (25 or 50 kHz) and α is a small unsigned fractional number. Then the CW tone corresponding to subcarrier index k may be written as:

$$cw_tone(k) = A_k \exp(j(2\pi \Delta f(k + \alpha) + \phi_k))$$

It can then be shown that the phase difference of the CW tone seen by a CM at two successive scattered pilot locations is given by the equation below, where T_{FFT} is the FFT time (20 or 40 μ s) and T_{CP} is the cyclic prefix time.

$$\Delta\phi = 256 \pi \alpha \left(\frac{T_{FFT} + T_{CP}}{T_{FFT}} \right)$$

If α is chosen such that $\Delta\phi$ is equal to $(2n+1)\pi$ then the contribution of the CW tone to the mean will cancel out every two scattered pilots. Therefore, over an even number of scattered pilots the entire contribution from the CW tone will be to the variance and not to the mean.

However, adjacent subcarriers are also impacted by the CW tone if its frequency is offset from the subcarrier frequency grid. Therefore, the value of the offset is to be kept as small as possible. The smallest value of α to give $\Delta\phi$ equal to $(2n+1)\pi$ at subcarriers 128 symbols apart is:

$$\alpha = \frac{T_{FFT}}{256(T_{FFT} + T_{CP})}$$

For a typical case of a 20 μs symbol (i.e., 4K FFT) with 2.5 μs cyclic prefix, this gives a value of α of 0.003472. The corresponding frequency offset αΔf is 173.6 Hz.

This frequency offset can be halved by choosing α such that Δϕ is equal to π/2. Then the contribution of the CW tone to the mean is cancelled out every four scattered pilots. This is acceptable because averaging for MER calculation is done over many scattered pilots. Frequency offsets close to the precise values obtained from the above equations may be used for sounding.

7.2.6.2.2 Ramping to Reduce ICI at Start and End

CW tones, if created with an abrupt start and end, can cause excessive ICI (Inter-Carrier Interference) in the symbols overlapping with start and end of CW tones. This is because tone start/end cannot be synchronized to downstream symbol boundaries of all Measurer CMs. Therefore, it is important that CW tones start and end with tapering to have a smooth transition from amplitude 0 to full amplitude. Linear ramping, where amplitudes vary linearly from 0 to full amplitude, achieves necessary ICI reduction with reasonable ramping length (Figure 17).

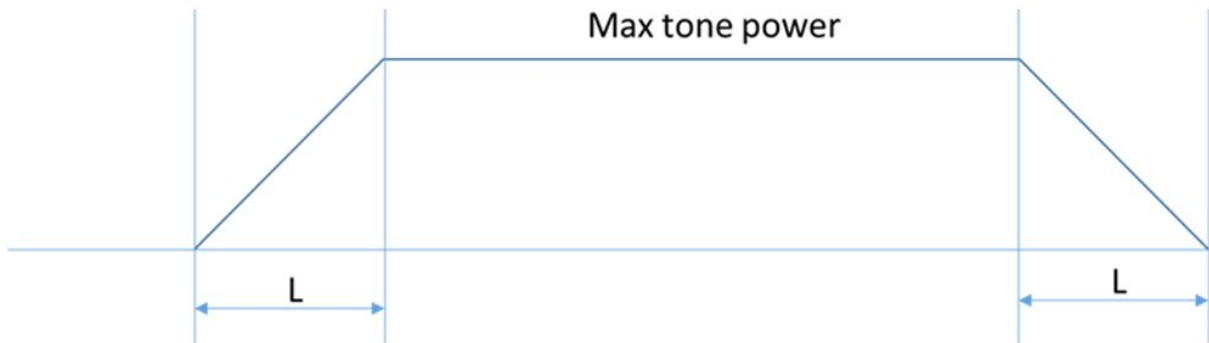

Figure 17 - CW Tone Power Ramp Up and Ramp Down in Start and End to Reduce ICI to Adjacent Subcarriers

Amplitude of CW tones at the Measurer CM can be up to 17 dB higher than the average received subcarrier power level. This accounts for possible +10 dB boosting and +7 dB leakage, from sounding CM to Measurer CM. Table 27 shows the worst-case ICI level for symbols affected by the linear tapered part of CW for 8K OFDM mode with receiver window of 64. Ramping length, L, is given in natural OFDM sample rate of 204.8 MHz. CW tone is assumed to be 17 dB above average subcarrier level at the Measurer CM.

Table 27 - Worst Case ICI for Ramped CW Tones Relative to Average DS Data Subcarrier Power

Adjacent Carrier Index	L = 32*8192	L = 64*8192	L = 128*8192
1	-29 dB	-35 dB	-41 dB
2	-35 dB	-41 dB	-47 dB
3	-39 dB	-45 dB	-51 dB

When initiating transmission of CW sounding tones, the FDX CM MUST increase tone amplitude linearly from zero to its maximum over 128 * 8192 samples in OFDM sample rate of 204.8 MHz.

When terminating transmission of CW sounding tones, the FDX CM MUST decrease tone amplitude linearly from its maximum to zero over 128 * 8192 samples in OFDM sample rate of 204.8 MHz.

The reasons for ramping length 128*8192 are as follows.

- This lowers ICI level beyond second neighboring subcarrier to below -51 dB.

It is clear from the ICI data given in Table 46 in Appendix I that ramping brings the ICI contribution in transition regions to well below the ICI level due to frequency offset itself.

7.2.6.2.3 Phase Randomization

With a reasonable number of CW tones required to do sounding, any potential for CW tones to constructively combine and form large time domain peaks should be avoided. If all the CW tones start off with the same phase, we clearly have constructive addition at time zero. With the linear ramping of amplitude at the beginning of CW tones, we can expect this peak at time 0 to not cause any issue. However, CW tones can be expected to periodically produce similar peaks with time.

For example, assume CW tones are generated at a set of frequencies, which are a multiple of 50 kHz (4K OFDM mode) plus a small frequency offset, as specified. If all CW tones start with the same starting phase, then all CW tones will achieve the same phase after 20 us (1/50 kHz), but with a different value than the starting phase. Regardless of the value of the starting phase, all CW will add constructively whenever all the starting phases are the same. Therefore, a peak is achieved once every 20 us in this case.

To avoid the above issue, the starting phases of CW tones are made random. The pseudo random sequence, w_m , described in section 7.5.15.3 of [DOCSIS PHYv3.1] for pilot modulation, is also applicable for CW tone phase randomization. The FDX sub-band may comprise 1 or 2 OFDMA upstream channels, depending on the FDX allocated spectrum, as defined in Section 7.2.2.5.5. For sub-bands with 2 OFDMA upstream channels, denote upstream channel occupying the lower and upper half of a sub-band as US0 and US1 respectively. For sub-bands with 1 OFDMA upstream channel, denote this upstream channel as US0. The starting phase for CW tone corresponding to upstream subcarrier index k , Φ_k , is derived as follows:

Define m such that $m = k$ for US0 channels, and $m = k + 4096$ for US1 channels.

$w_m = 0$: CW starting phase, $\Phi_k = 0$

$w_m = 1$: CW starting phase, $\Phi_k = \pi$

Please note: the starting phases of CW tones are defined as the relative phase offsets to each other, and there could be a common phase offset from the specified starting phases for all the CW tones.

7.2.6.2.4 CWT Transmit Power and Boosting

Transmit power of the CW tones adheres to the same rules as regular data subcarriers including pre-equalization, with the exception of boosting (raising the transmit power of a CW to a level above the commanded power per subcarrier). Boosting level, K_{boost} , is communicated by the FDX CMTS to the FDX CM. The FDX CM MUST apply the commanded boosting level when transmitting CW tones. Same K_{boost} is applied to all CWT within a sub-band, a different K_{boost} can be applied to different sub-bands. The range of K_{boost} value is between 0 to +10 dB with 1/4dB resolution. The FDX CMTS MUST limit the value of boosting (K_{boost}), the number of CW tones in a minislot, the number of CW tones per sub-band (n), and the total number of CW tones per FDX CM which are transmitted concurrently (N), according to the following rules:

- The total transmit power of any minislot containing CW tones does not exceed an equivalent total transmit power of that minislot if it were to contain data subcarriers without exclusions (commanded power for that minislot).
- $n \leq 255$
- $N \leq 765$

$$0 \leq K_{\text{boost}} [\text{dB}] \leq \text{Max}(0, \text{Min}(10 * \log_{10}(255/N), 10))$$

7.2.6.2.5 CMTS Requirements

- The FDX CMTS MUST set the modulation of data subcarriers corresponding to sounding CWs to zero bit-loading for the duration of the sounding test.
- The FDX CMTS MUST NOT grant any CM US transmission opportunities at the frequency locations of sounding CWs. In addition, on the upstream, the CMTS can set the modulation order of the 3 data

subcarriers on each side of every sounding CW to zero bit-loading or reduce the modulation order enough to avoid errors on corresponding data subcarriers due to ICI.

- The FDX CMTS MUST support configuring and advertising the center frequency of the sounding CW signals which are offset from the OFDM subcarrier center frequency and render one of the following phase rotations across the Scattered Pilot period: $\pi/2$, $2\pi/3$ or π . Once it receives the commands from the FDX CMTS that configures and advertises the center frequency of the sounding CW signal, the FDX CM MUST use Table 28 - Fractional Frequency Offset as a Function of Phase Rotation, N_{cp} and Subcarrier Spacing to compute the fractional frequency offset from the OFDM subcarrier center frequency. CW frequency offset is then computed from the fractional frequency offset and the subcarrier spacing as follows:

$$CW \text{ Frequency Offset} = \text{Fractional Frequency Offset} * \text{Subcarrier Spacing}$$

Table 28 - Fractional Frequency Offset as a Function of Phase Rotation, N_{cp} and Subcarrier Spacing

Subcarrier Spacing	N_{cp}	Fractional Offset for $\pi/2$ phase rotation across Scattered Pilot period	Fractional Offset for $2\pi/3$ phase rotation across Scattered Pilot period	Fractional Offset for π phase rotation across Scattered Pilot period
50 kHz	192	1/536	1/402	1/268
	256	1/544	1/408	1/272
	512	1/576	1/432	1/288
	768	1/608	1/456	1/304
	1024	1/640	1/480	1/320
25 kHz	192	1/524	1/393	1/262
	256	1/528	1/396	1/264
	512	1/544	1/408	1/272
	768	1/560	1/420	1/280
	1024	1/576	1/432	1/288

- The FDX CMTS MUST support a configurable variable (K_{boost}) per sub-band that is used to boost the level of sounding CW signals as described in Section 7.2.6.2.4.

Refer to Appendix II for an example of using the MER measurement from the CMs using CWT sounding in the FDX band to form IGs.

The FDX CMTS MUST ensure the subcarrier index that specifies a CW signal frequency location in the CW-REQ message matches a DS subcarrier where a coinciding US subcarrier is also defined per UCD message ([DOCSIS MULPIv4.0]) for OFDMA transmission on the FDX downstream channel under test.

The FDX CM MUST set the center frequency of the CWT signal using the parameters specified in the CW-REQ message based on the following calculation:

$$CWT \text{ Signal Center Frequency} = CWT \text{ Center Frequency of Subcarrier } 0 + CW \text{ subcarrier Index} * \text{Subcarrier Spacing} + CWT \text{ Frequency Offset}$$

Note: CW_subcarrier_index is a vector of indices locating the CWT subcarrier frequencies.

The FDX CM MUST set the CWT subcarrier frequencies in accordance with the frequency accuracy requirements of Section 7.2.4.2.1, Channel Frequency Accuracy. The FDX CM MUST synchronize the frequency accuracy of the CWT subcarriers with the data subcarriers (e.g., derived from the same Master Clock).

7.2.6.2.6 CM Requirements

- The FDX CM MUST transmit the sounding CW signal at the center frequency specified in the sounding message.

The FDX CM reports MER values when it participates as a listener in initial sounding opportunities using the same process defined for RxMER defined in section 9.3.6 of [DOCSIS PHYv3.1].

- The FDX CM MUST transmit sounding CW signals at power levels equal to the level of the ranged subcarriers at the sounding frequencies plus K_{boost} for the sub-band.

When the FDX CM receives an OPT-REQ message [DOCSIS MULPIv4.0], it is required to calculate Rx MER as defined in section 9.3.6 of [DOCSIS PHYv3.1] and return the calculated value. The FDX CMTS applies this method for determining Rx MER at the FDX CM when the FDX CM participates as a listener in periodic sounding opportunities.

7.2.7 Echo Cancellation at the Cable Modem

Echo cancellation is used to improve FDX CM receiver performance by cancelling Adjacent Leakage Interference (ALI) and Adjacent Channel Interference (ACI) resulting from the CM's own upstream transmissions. The CM referenced in this section and its subsections are FDX CMs.

ALI refers to the power that leaks into a downstream channel of a CM from an upstream transmission of the same CM in another part of the FDX spectrum. The CM has to transmit at a relatively high-power level to be received by the FDX Node, and as a result the power of the out-of-band components of this upstream transmission are comparable to the power of a downstream signal in an adjacent channel at CM input. Some of this upstream out-of-band power gets coupled into the receiver path through the coupler within the CM, shown in Figure 18. Further out-of-band power gets added to the received signal through reflections in the drop cable and at the connection with the main cable. The sum of all these out-of-band components of the upstream transmission that gets added to the downstream signal is referred to as ALI. This ALI level can be significantly higher than the noise floor of the system Figure 19 and, therefore, its cancellation is required for the CM to decode data in subcarriers with moderate to high order QAM constellations.

ACI refers to the power that remains in the same band as the transmitted signal but gets added into the receiver path through the coupler within the CM as well as through reflections in the cable and its taps. This is significantly stronger than ALI, but it is not an in-band interference like ALI. Its main effect is in overloading the receiver circuitry. Hence, although precise cancellation is not needed as in the case of ALI, some cancellation is beneficial to reduce the load on the receiver analog and analog-to-digital conversion circuitry. It is important to note that the ALI and ACI referred to above, illustrated in Figure 19, are interferences resulting from upstream transmissions of the specific receiving CM, and hence these can be categorized as self-ALI and self-ACI, respectively. The reception of this CM can also be impacted by ALI and ACI from upstream transmissions of other CMs in the cable plant, in particular, other CMs in the same IG. The CM is required only to cancel its own ALI and ACI, that is, self-ALI and self-ACI, sufficiently to meet the performance requirement defined in Section 7.2.5.12.3.

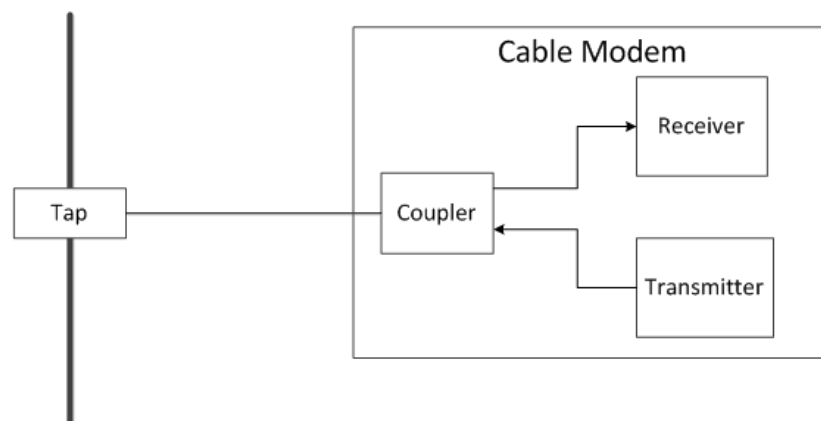

Figure 18 - Cable Modem and Drop Cable Schematic

Only the first tap is shown in Figure 18 because reflections from beyond this tap are too small to impact CM performance.

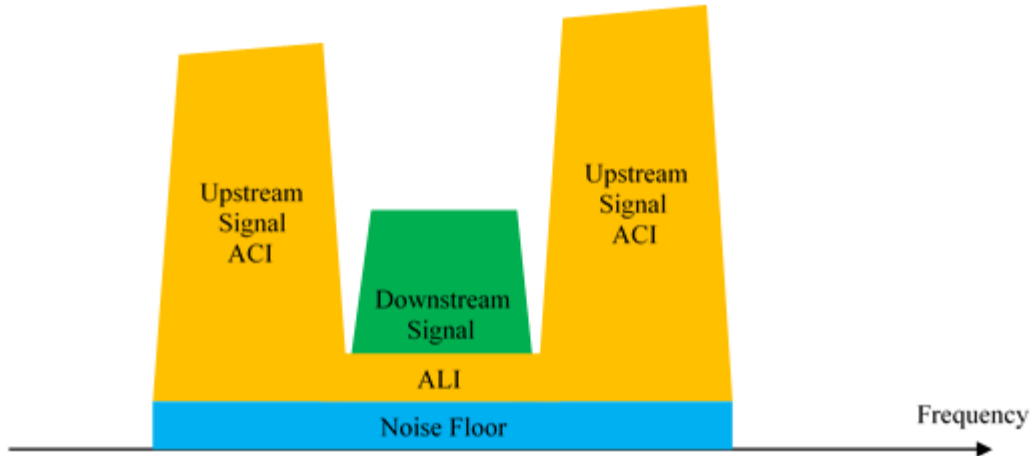

Figure 19 - ALI and ACI Illustrated in the Spectral Plane

Echo cancellation can only be carried out after Interference Group (IG) discovery has been completed and the CM has been assigned to a Transmission Group (TG). All the CMs in a TG have the same Resource Block Assignment (RBA), that is, the definition of upstream/downstream for each of the FDX channels. Hence after TG assignment the CM knows its upstream and downstream channels, and it is in a position to commence the training of the echo cancellers associated with each of the downstream channels.

The sequence of operations in the process of entry of a CM into the FDX band is illustrated in Figure 20.

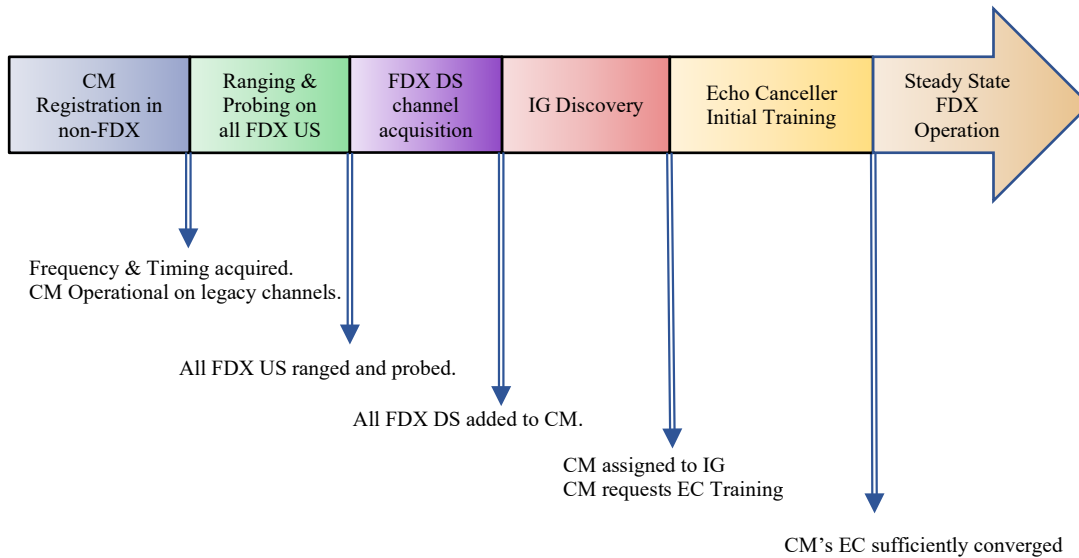

Figure 20 - CM FDX Entry Sequence

An FDX CM that wants to join the FDX network is to begin by first registering with CMTS using the legacy band. The CM becomes operational on legacy channels. At some point after this, the CMTS adds FDX channels to the CM, performs IG Discovery for that CM, and eventually assigns a TG-ID to the CM.

At this point, the CM knows which sub-bands are upstream and downstream, and hence, it is in a position to train the echo cancellers needed for receiving the downstream channels. However, before training can commence an exchange of information between CM and CMTS is needed to identify the capabilities of the Echo Canceller (EC) within the CM. EC capabilities define what the CMTS need to provide in order to enable the CM to do echo canceller training. These include any special OFDM symbols that the CMTS has to transmit on downstream channels and any specific grants that the CMTS has to provide on upstream channels.

Initial training will work out the impulse or frequency responses that the CM needs for echo cancellation. Once initial EC training is complete, the CM can transmit user data upstream in its allotted upstream channels without significantly impacting its FDX downstream channels.

Control of Echo Cancellation Training is detailed in [DOCSIS MULPIv4.0].

7.2.7.1 Echo Cancellation Training Stages

There are two stages of echo canceller training:

1. Initial training
2. Periodic training

Echo Cancellation Training is performed on a per-RBA basis. Initial training occurs when a CM joins the FDX band. It involves acquiring the impulse or frequency response, of the upstream channel as seen by the CM, in order to facilitate echo cancellation.

Periodic training is needed at regular intervals to account for changes in the response of the channel mentioned above. The periodicity of these updates, namely, how frequently these are done, depends on the type of cable plant as well CM implementation. The EC training protocol can be designed to adapt this update frequency based on the performance characteristics of cable modems. For example, if performance of the CMs does not deteriorate between successive updates, the Periodic Training interval can be increased.

In the above description, it has been assumed that after initial training the EC of a CM enters a tracking state for that RBA. However, the EC can lose convergence for a variety of reasons, for example, burst noise during training. Therefore, a CM will be able to identify that its EC has lost convergence and report this to the CMTS. In return, the FDX CMTS provides whatever training opportunities the FDX CM requests to enable the CM to return to operating within the FDX band.

7.2.7.2 Echo Cancellation Training Status

The CM will incorporate features to identify that its EC has converged. If the convergence is unsatisfactory then the CMTS might have to provide further training opportunities to the affected CM, for example, by sending further ZBL blocks. The protocol allows the CM to indicate what types of additional training opportunities it needs.

The CM will report its EC training status to the CMTS when needed, as described in [DOCSIS MULPIv4.0].

7.2.7.3 Echo Cancellation Algorithms

Echo Cancellation algorithms are proprietary to CM design and hence will not form part of this specification. Furthermore, no specific echo cancellation algorithms are mandated by this specification.

This specification only covers the features that the CMTS has to provide to facilitate the application of these echo cancellation algorithms.

7.2.7.4 Zero-Bit-Loaded Blocks in Downstream Channels

For initial and periodic training, an FDX CM might require zero-bit-loaded OFDM symbols. If one or more FDX CMs requiring ZBL for update training exist in the FDX band, or if an FDX CM requiring ZBL for initial training

is awaiting EC initial training, the FDX CMTS MUST include an appropriate ZBL Block in the corresponding downstream channel.

A ZBL Block is a block of zero-bit-loaded (ZBL) symbols inserted by the FDX CMTS into a downstream OFDM channel. The FDX CMTS MUST ensure that these ZBL symbols conform to the definition of such symbols given in section 7.5.5.3 of [DOCSIS PHYv3.1], “Randomization,” since there might be FDX-L CMs receiving this downstream. Therefore, these ZBL symbols are to be created prior to time and frequency interleaving by inserting BPSK subcarriers instead of data subcarriers. Each such symbol will have two NCPs, a Null NCP and a CRC NCP. All pilots and PLC will remain as in a data carrying OFDM symbol. A ZBL block will take the structure shown in Figure 21.



Figure 21 - ZBL Block for Echo Cancellation

The initial period is intended to configure the downstream transmission for inserting ZBL symbols and for flushing out the interleavers and network jitter smoothing buffers. The ZBL period in Figure 21 is the period in which all active subcarriers of the OFDM symbols, except the PLC and NCP subcarriers, are BPSK modulated. If the convolutional time-interleaving depth is I there will be $(I-1)$ symbols with partially ZBL symbols in the initial period and also in the final period.

The number of ZBL symbols (M) in the ZBL Period depends on the number of CMs in the FDX band requiring ZBL symbols and state of those CMs. The length of this ZBL period will be:

$$M = \sum_{i \in CM_{ZBL}} L_{ZBL_update,i}$$

Here $L_{ZBL_update,i}$ is the number of ZBL symbols needed by the CM_i to do a periodic update of the EC coefficients. The set CM_{ZBL} is the set of CMs in the cable plant that require ZBL symbols for EC update training.

Similarly, the parameter $L_{ZBL_initial,i}$ defines the number of ZBL symbols needed by CM_i to do initial training.

The CMTS can combine initial training of multiple CMs that require ZBL for initial training.

The CMTS can also combine initial training of some CMs with periodic training of other CMs.

The ZBL period will change based on these combinations.

The CMTS will signal the beginning of the ZBL period and the segments of the ZBL period intended for individual CM as described in [DOCSIS MULPIv4.0].

7.2.7.5 Echo Cancellation Upstream Grants

Echo cancellers in CMs might require grants in upstream channels defined by the RBA, for the purpose of ALI or ACI initial or periodic training. These features are part of the CM EC T-REQ message. The use of grants in the upstream channel for ECT is called foreground training.

If a CM requests foreground training with ZBL, the CMTS synchronizes the upstream grants with downstream ZBL blocks.

It is possible that the CM might find it difficult to train the EC within the cable environment. For example, the CM might have specified one method of training initially for an RBA. However, during operation the CM may decide different training parameters are desired. The CM would then send the CMTS a new EC training request. The EC training protocol defined in [DOCSIS MULPIv4.0] provides flexibility for CMs that want to change some aspects of EC training while in operation in the FDX band.

7.2.8 Triggered RxMER Measurements

FDX CMs have the ability to measure RxMER over all subcarriers simultaneously, not just over scattered pilots, continuous pilots, and PLC preamble, as described in section 9.3.6 of [DOCSIS PHYv3.1]. This type of RxMER measurement is called a Triggered RxMER because it is triggered in response to a specific event. There are three types of triggered events defined for FDX CMs: OUDP Sounding Triggered Measurements, ECT RxMER Probe-Triggered Measurements, and Time-Triggered Measurements. The triggers of all of these measurements are set up using the OPT messaging specified in MULPI.

OUDP Sounding Triggered Measurements are used for measuring interference between CMs for the purposes of establishing or refining Interference Groups. For OUDP Sounding Triggered Measurements, the CM performing the measurements is called a Measurer CM and it makes the measurements in response to grants in MAPs to another CM's OUDP Sounding SID or OUDP Testing SID. See MULPI for details.

ECT RxMER Probe-Triggered Measurements are intended to measure a CM's receive capabilities during worst case ALI and ACI and are typically used for setting downstream bit-loading after completion of Echo Cancellation Training. For ECT RxMER Probe-Triggered Measurements, the CM makes the measurements in response to ECT RxMER Probes allocated to its own ranging SID.

The Time-Triggered Measurement is a generic tool that allows the CMTS to measure a CM's RxMER under scenarios of the CMTS's choosing. For the Time-Triggered Measurements, the CM starts its measurements when its downstream time matches a predetermined downstream timestamp value.

Because these triggered measurements use all subcarriers on all symbols and not just scattered pilots, continuous pilots, and PLC preamble, the CMTS is responsible for providing ZBL on the measured downstream during the measurement period, except for the PLC subcarriers and NCP subcarriers.

7.2.8.1 Measuring Period

The structure of an OUDP sounding period is shown in Figure 22.

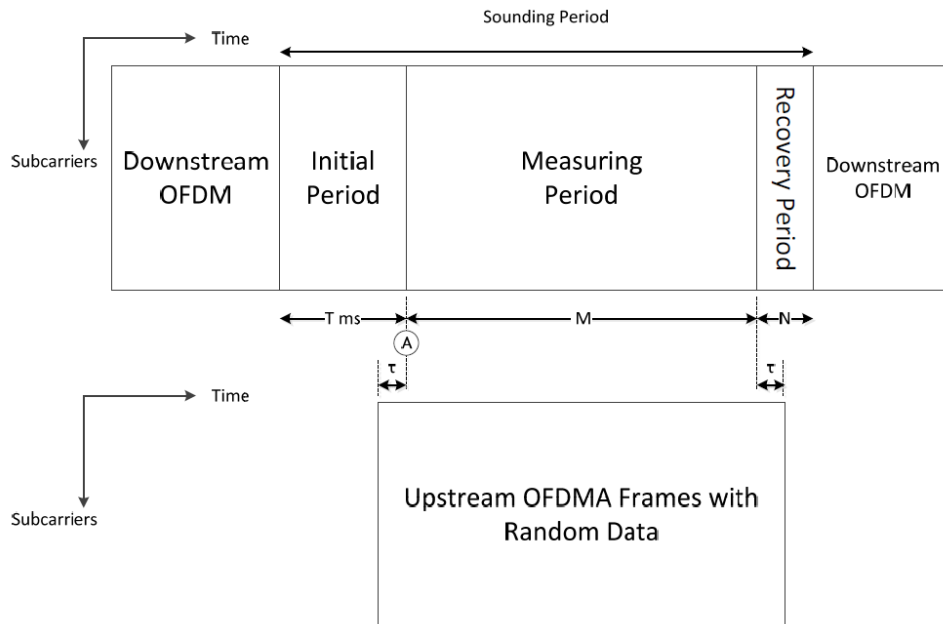

Figure 22 - Sounding Period for OUDP Method

The structure of a generic triggered measurement period is shown in Figure 23.

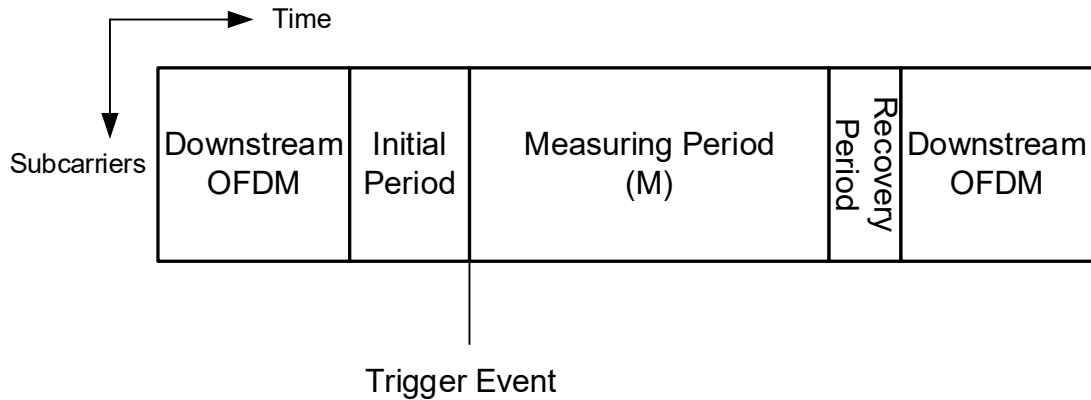

Figure 23 - Generic Triggered Measurement

The Sounding Period for the OUDP sounding method and the Generic Triggered Measurement consist of an Initial Period, a Measuring Period, and a Recovery Period, as shown in Figure 23. The Initial Period is intended to enable the CMTS to configure the system for the required measurement and to flush out the contents of the interleaving buffers. The CMs will be operating as usual during the Initial Period and hence the contents of the interleaving buffers will get decoded.

For all Triggered Measurements, the beginning of the Measuring Period will be conveyed to the CMs some time before the commencement of the Measuring Period, as defined by the [DOCSIS MULPIv4.0] specification.

The Measuring Period is defined using a parameter M OFDM symbols with a maximum value of 1024 (see [DOCSIS MULPIv4.0]).

The length of the Recovery period is defined using a parameter N in terms of OFDM symbols (see [DOCSIS MULPIv4.0]).

The FDX CMTS MUST begin inserting Zero-Bit-Loaded (ZBL) symbols into the transmit sequence at a point in the Initial Period, accounting for time interleaving, such that all subcarriers other than NCP and PLC subcarriers in the transmitted OFDM symbols are zero-bit-loaded BPSK, throughout the Measuring Period.

The FDX CMTS MUST ensure that these ZBL symbols conform to the corresponding definition in section 7.5.5.3 of [DOCSIS PHYv3.1]. Therefore, these have to be inserted before time and frequency interleaving; each ZBL symbol has to contain two NCPs, namely, a Null NCP and a CRC NCP.

For OUDP Sounding, the FDX CMTS MUST ensure that this measuring period is fully encompassed by OUDP OFDMA symbols from the Test CM. Furthermore, the FDX CMTS MUST ensure that the Test CM transmits OUDP frames for a time period T before the measuring period and a time period T after the measuring period (*this T may be defined in symbols*). The minimum value of T is 50 μ s (or one symbol) and the maximum value of T is 5 ms (or 128 symbols) (see [DOCSIS MULPIv4.0]).

For OUDP Sounding, it is expected that the Measurer CMs will save the receiver state variables comprising gain, timing/frequency offsets and other relevant parameters, shortly before the beginning of upstream OUDP frames, and restore these shortly after the end of the upstream OUDP frames.

For ECT RxMER Probe Triggered Measurements, the FDX CMTS MUST ensure that ECT RxMER Probes are allocated to the measuring CM for the duration of the requested measurement. These probes do not need to be contiguous and can be sent in groups of 6 or more. (See the ECT section of [DOCSIS MULPIv4.0] for further restrictions.)

For Time-Triggered Measurements, the FDX CMTS ensures that the desired conditions occur throughout the measurement period.

The FDX CMs MUST use all M symbols of the measuring period to measure subcarrier MER for triggered measurements. MER is measured on subcarriers which may contain data during some portion of the time due to the

NCP data subcarriers, non-preamble PLC subcarriers, and frequency interleaving. For the instances of data occurring in a subcarrier in one of the OFDM symbols of the measuring period, a decision-directed MER measurement is required, which is different than described in section 9.3.6 of [DOCSIS PHYv3.1]. Since the constellation point is not known *a priori* for the Measurer CM in this case, unlike for the conditions provided in section 9.3.6 of [DOCSIS PHYv3.1], the error vector power may be computed as the square of the magnitude from the closest constellation point in the decision-directed MER measurement.

The FDX CM MUST compute the MER values of PLC subcarriers, with the accuracy achievable from an averaging period M subcarriers, for MER values greater than 15 dB, when all M OFDM measurer symbols are PLC preamble symbols. This accuracy requirement and all following PLC subcarrier MER accuracy requirements do not apply when any of the M symbols in the averaging period are not preamble symbols. Although there is no accuracy requirement below 15 dB for PLC subcarriers, the FDX CM MUST ensure that the MER accuracy degrades gracefully between 15 dB and 13 dB.

The FDX CM MUST NOT set the MER of a PLC subcarrier with MER below 13 dB to a value greater than 15 dB.

The FDX CM MUST compute the MER values of non-PLC subcarriers, with the accuracy capable from an averaging period M subcarriers, for MER values greater than 5 dB, when all of the symbols are known *a priori* by the Measurer CM (no data symbols among the M measurer symbols for a given subcarrier). There are no accuracy requirements for any MER value computed where any OFDM symbol in a subcarrier's M OFDM measurement symbols is a data symbol.

Although there is no accuracy requirement below 5 dB for non-PLC subcarriers, the FDX CM MUST ensure that MER accuracy degrades gracefully between 5 dB and 3 dB.

The FDX CM MUST NOT set the MER of a non-PLC subcarrier with MER below 3 dB to a value greater than 5 dB.

The FDX CM MUST report each MER value in dB using an unsigned 8-bit number comprising 2 fractional bits, i.e., *u6.2*.

7.2.8.2 Triggered RxMER Measurement Procedure

The MER measurement procedure for OUDP sounding is to be as defined in section 9.3.6 of [DOCSIS PHYv3.1] for OFDM symbols which are known to the CM *a priori*. For OFDM symbols which contain NCP data or PLC subcarrier data, the MER is defined as per section 9.3.6 of [DOCSIS PHYv3.1], but with the error vector power for such symbols defined as the error vector power between the received value and the ideal constellation point closest to the received value. In calculating MER when data symbols occur, the CM may use alternative methods rather than relying on the minimum distance error vector power; some alternative methods are provided in the following paragraph.

MER of non-PLC subcarriers may also be worked out using the above method. As mentioned earlier, there is some complexity in working out the locations of the NCP subcarriers in the transmitted domain as well as NCP modulations. Since the NCP subcarriers occur in isolation as a result of interleaving, the MER of a NCP subcarrier may be replaced by that of an adjacent BPSK subcarrier. One method of further simplifying this process, without even working out NCP subcarrier locations, consists of treating all non-PLC subcarriers as BPSK in working out the MER. This will give poor MER estimates for NCP subcarriers because of the incorrect assumption relating to their modulation. If a median filter is used to smooth out the subsequent MER profile this will automatically replace the poor MER values of NCP subcarriers with the median of the neighborhood.

7.2.8.3 Upstream Power During Triggered Measurements

During Triggered Measurements taken in one sub-band while the CM is actively transmitting in another sub-band, the CM uses the power appropriate for normal operation of the transmitting sub-band.

7.3 PHY Sublayer for FDD OFDM

FDD DOCSIS 4.0 capability requires additional functions to be added to the DOCSIS 3.1 requirements. These new functions are specified in this section. As with previous generations of DOCSIS technologies, DOCSIS 4.0-compliant devices will be backward-compatible with previous generations of DOCSIS technology. The FDD Upstream Allocated Spectrum is comprised of only upstream FDD channels between 108 MHz and the chosen

upstream upper band edge and is further subdivided into a number of 96 MHz upstream OFDMA channels as appropriate for the chosen upstream upper band edge. Additional detail regarding the FDD Upstream Allocated Spectrum is provided below in Section 7.3.2, its subsections, and Figure 25.

The CMTS assignment of the FDD upstream band plan can be done incrementally over time as a transition strategy, from existing DOCSIS networks to extended spectrum DOCSIS networks, as DOCSIS 4.0 FDD CMTSs and modems become available.

For an FDD DOCSIS system, a distributed architecture is assumed. Thus, this portion of the specification refers to the physical layer functionality of an FDD-capable CMTS as the FDD Node. The CMTS is occasionally used to refer to the total functionality across the MAC layer and the Physical layer.

A DOCSIS 4.0 FDD-compliant Node supports upstream and downstream channels in separate areas of the spectrum as provided by the chosen band plan and the chosen FDD Upstream Allocated Spectrum. A DOCSIS 4.0 FDD-compliant CMTS allocates FDD channels to cable modems by providing modems access to upstream channels within the configured FDD Upstream Allocated Spectrum. FDD channels can be bonded with non-FDD channels and with other FDD channels.

A DOCSIS 4.0-compliant FDD CM supports two modes of operation related to FDD:

1. DOCSIS 3.1 Backward Compatibility Mode: When an FDD CM is using a 204 MHz duplex filter and is operating with a DOCSIS 3.1 CMTS, and there is negligible energy above 1218 MHz, the FDD CM behaves identically to a DOCSIS 3.1-compliant cable modem and adheres to the requirements in section 7 of [DOCSIS PHYv3.1].
2. DOCSIS 4.0 FDD Mode: A DOCSIS 4.0 FDD CM is in this mode when it is on a DOCSIS 4.0 FDD plant with 204 MHz split (high-split) or any of the UHS defined splits UHS-300, UHS-396, UHS-492, or UHS-684. In a high-split mode, the CM operates with a single TCS, and in any of the UHS modes, the CM operates with two TCSs (TCS and TCS_FDD).

The CM is allowed to reboot when transitioning between the two operational modes or between any of the splits in DOCSIS 4.0 FDD Mode.

A DOCSIS 4.0-compliant FDD node supports two modes of operation related to FDD:

1. Legacy Transition Mode: When using Downstream Lower Band Edge below 258 MHz, the node is operating in a mode that transmits legacy video SC-QAM and other non-DOCSIS signals below 258 MHz and is restricted to 1,536 MHz of occupied downstream spectrum. The CMTS may not define any upstream channels that would overlap with the downstream transmissions.
2. DOCSIS 4.0 FDD Mode: A DOCSIS 4.0 FDD node is in this mode when it is on a plant capable of high-split or any of the UHS defined splits.

7.3.1 FDD Node Reference Interfaces

This specification assumes the downstream CMTS modulator is located in an FDD node in a cable television plant.

[DOCSIS PHYv3.1] defines specifications for a CMTS which is presumed to be located at a headend or hub site. However, the MHA v2 and FMA family of specifications describe an alternate system architecture in which the downstream modulator is located within an optical node as part of a DCA node. Most, but not all, of the requirements for a PHY Device in a MHA v2 architecture and a MACPHY Device in FMA are the same as those which apply to an Integrated CMTS.

The purpose of this section is to define the RF characteristics required in the OFDM downstream modulator of a DCA function located within an optical node, with sufficient specificity to enable vendors to build devices meeting the needs of cable operators around the world.

In comparison to reference interfaces defined in annex D of [DOCSIS DRFI], the FDD Node defines two additional interfaces, E and F, that compensate for upstream and downstream power tilt. These interfaces are indicated in Figure 24 below.

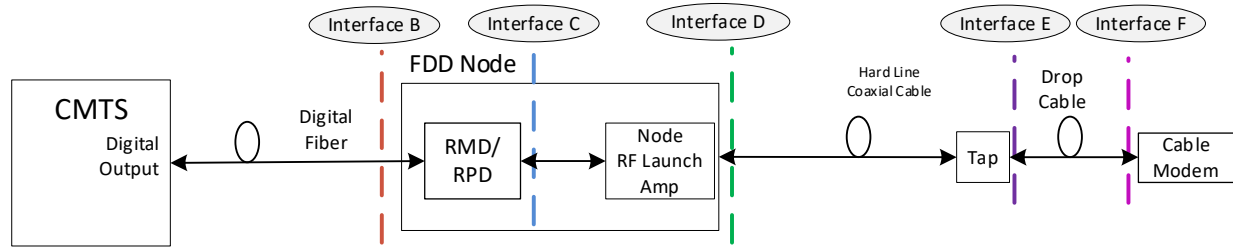

Figure 24 - FDD Node Reference Interfaces

7.3.2 Upstream and Downstream Frequency Plan for FDD Operation

For FDD DOCSIS 4.0 devices operating in FDD mode, this section augments section 7.2 of [DOCSIS PHYv3.1] and corresponding subsections unless otherwise noted. The following spectrum definitions are based on the system requirement that the downstream transmission frequencies always reside above the upstream transmission frequencies in the cable plant.

For DOCSIS CMTSs that implement FDD DOCSIS capability and FDD CMs, the following spectrum definitions are based on the legacy DOCSIS requirement for downstream transmission frequencies to always reside above the upstream transmission frequencies in the RF spectrum.

DOCSIS 4.0 FDD nodes are required to support two concepts shown in Table 29. The first is that the output at Interface C has to be capable of transmitting 1,536 MHz of occupied downstream spectrum when the Downstream Lower Band Edge is at 258 MHz and below. In order to assist operators in a more gradual transition to DOCSIS 4.0 FDD, nodes are required to support legacy Downstream Lower Band Edges below 258 MHz but are not required to support greater occupied downstream spectrum. If the Downstream Lower Band Edge is 258 MHz, then the occupied downstream spectrum is 1,536 MHz and the Downstream Upper Band Edge will be 1,794 MHz. If the Downstream Lower Band Edge is at a higher frequency, the occupied downstream spectrum will be less than 1,536 MHz. If the Downstream Lower Band Edge is at a lower frequency, the node is only required to support an occupied downstream spectrum of 1,536 MHz. The following items should be noted when nodes are transmitting with a Downstream Lower Band Edge lower than 258 MHz.

- DOCSIS 4.0 FDD cable modems are not required to receive frequencies below 258 MHz; therefore, any node transmitting DOCSIS channels below 258 MHz will only be capable of being received by DOCSIS 3.1 and earlier cable modems. A DOCSIS 4.0 FDD node is also not required to transmit DOCSIS channels below 258 MHz, so transmission of DOCSIS channels below 258 MHz is unsupported. Operators are strongly encouraged to limit downstream frequencies below 258 MHz to video SC-QAM and other non-DOCSIS signals.
- The ability of a DOCSIS 4.0 FDD node to support Downstream Lower Band Edges below 258 MHz should be viewed by operators as providing options to transition to a fully DOCSIS 4.0-compliant network. Future DOCSIS versions could remove support for Downstream Lower Band Edges below 258 MHz.
- The 1,536 MHz occupied downstream spectrum is not required to be contiguous. It is possible, for example, for the Downstream Lower Band Edge to be 108 MHz, the Downstream Upper Band Edge to remain at 1,794 MHz, and leave a hole in the occupied downstream spectrum of 150 MHz at LTE frequencies. Table 29 assumes that the occupied downstream spectrum is contiguous, but that is not a requirement of the specification.

The second concept introduced in DOCSIS 4.0 FDD is that of a variable-width transition band between the Upstream Upper Band Edge and the Downstream Lower Band Edge. In DOCSIS 3.1 and previous DOCSIS specifications, both the Upstream Upper Band Edge and Downstream Lower Band Edge had a defined frequency. With the introduction of UHS-300, UHS-396, UHS-492, and UHS-684, the traditional fixed band edges on each side of this transition band get increasingly large. Since each megahertz of downstream spectrum has a value to the operators, these increasingly larger transition bands come at a cost to the operators. To encourage the vendor community to innovate in order to reduce this width of the transition band without requiring lengthy updates to the specification text, DOCSIS 4.0 FDD keeps the Upstream Upper Band Edge at a fixed frequency for all the new UHS splits. The Downstream Lower Band Edge, however, has a range that DOCSIS 4.0 FDD devices can support.

This range extends from the Upstream Upper Band Edge to the static Downstream Lower Band Edge initially specified. To ensure backwards compatibility, none of the splits defined in DOCSIS 3.1 and earlier support variable-width transition bands. Table 29 shows the band edges for each of the splits defined in DOCSIS 4.0 FDD and the devices to which these splits apply. Note that Table 29 assumes that the occupied downstream spectrum is contiguous; however, this is not a requirement of these specifications.

Table 29 - DOCSIS 4.0 FDD Band Edges and Device Applicability

(Assuming a Contiguous Occupied Downstream Spectrum)

Split Name	US Lower Band Edge	US Upper Band Edge	DS Lower Band Edge	DS Upper Band Edge	Device Applicability
Subsplit / Extended Subsplit	5 MHz	Up to 42 MHz (support for SCTE 55-1,2)	50 MHz to 54 MHz	1,584 MHz to 1,590 MHz	Node Only
EuroDOCSIS-Split	5 MHz	65 MHz (support for SCTE 55-1,2)	87.5 MHz	1,623.5 MHz	Node Only
Mid-Split	5 MHz	85 MHz (support for SCTE 55-1,2)	108 MHz	1,644 MHz	Node Only
High-Split	5 MHz	204 MHz	258 MHz	1,794 MHz	Node and Cable Modem
UHS-300 ¹	5 MHz	300 MHz	300 MHz–372 MHz	1,794 MHz	Node and Cable Modem
UHS-396 ¹	5 MHz	396 MHz	396 MHz–492 MHz	1,794 MHz	Node and Cable Modem
UHS-492 ¹	5 MHz	492 MHz	492 MHz–606 MHz	1,794 MHz	Node and Cable Modem
UHS-684 ¹	5 MHz	684 MHz	684 MHz–834 MHz	1,794 MHz	Node and Cable Modem
Table Note: Note1. DOCSIS 4.0 cable modems are not required to support upstream transmissions between 85 MHz and 108 MHz for these splits.					

The channel resources for FDD devices are summarized in Table 30; the requirements are described in the following subsections. DOCSIS 4.0 products support ATDMA type upstream channels, and these are referred to as upstream SC-QAM channels.

The FDD OFDMA channels operate on a predefined 96 MHz grid as described in Section 7.3.2.5.5.

Table 30 - Channel Resources for FDD Devices

Item	Device	OFDM/OFDMA	SC-QAM
Downstream Channel Support	CM	5 OFDM channels	32
	CMTS	6 OFDM channels	32
Upstream Channel Support	CM	7 OFDMA channels	4 upstream SC-QAM channels, operating within the diplex filter configuration. Optional support for up to 8 SC-QAM channels
	CMTS	8 OFDMA channels	4 upstream SC-QAM channels, operation dependent on operator deployment requirements. Optional support for up to 8 upstream SC-QAM channels.

7.3.2.1 Downstream CM Spectrum

The FDD CM MUST support a minimum of five independently configurable OFDM channels each occupying a spectrum of up to 192 MHz in the downstream.

The demodulator in the FDD CM MUST support receiving downstream transmissions to at least 1794 MHz.

The demodulator in the FDD CM MUST support agile placement of the OFDM channels within the entire supported downstream range.

The FDD CM MUST support a downstream lower band edge within the frequency range shown in Table 31 - FDD CM Diplex Filter Band Edge Frequencies.

The FDD CM MUST support a 1794 MHz downstream upper band edge. Support in this context includes the capability to demodulate up to the supported band edge.

For each of the upstream upper band edges supported, the FDD CM MUST support a Downstream Lower Band Edge within the frequency range shown in Table 31 - FDD CM Diplex Filter Band Edge Frequencies. Support in this context includes the capability to demodulate down to this supported band edge.

The FDD CM could be optimized to operate with any supported downstream upper band edge. The nature and operation of this optimization is vendor-specific.

7.3.2.2 Downstream FDD Node Spectrum

The FDD Node MUST support a minimum of six independently configurable OFDM channels each occupying a spectrum of up to 192 MHz in the downstream.

The FDD Node MUST support an occupied downstream spectrum width of 1,536 MHz.

The FDD Node MUST support a downstream upper band edge of 1794 MHz.

The FDD Node MUST support a downstream lower band edge of 258 MHz for DOCSIS 4.0 FDD operation.

The FDD Node MUST support a downstream lower band edge of 54 MHz for Legacy Transition Mode.

For each of the upstream upper band edges supported, the FDD Node MUST support a downstream lower band edge within the frequency range shown in Table 29 - DOCSIS 4.0 FDD Band Edges and Device Applicability.

7.3.2.3 Upstream CM Spectrum

Individual CM implementations can limit the spectrum over which the CM is able to transmit upstream signals.

As a result, in order to be compliant with this specification an FDD CM MUST support at least two of the following upstream upper band edges: 204 MHz; 300 MHz; 396 MHz; 492 MHz; and/or 684 MHz as shown in Table 31 - FDD CM Diplex Filter Band Edge Frequencies.

The FDD CM MAY support more than two of the following upstream upper band edges: 204 MHz; 300 MHz; 396 MHz; 492 MHz; and/or 684 MHz as shown in Table 31 - FDD CM Diplex Filter Band Edge Frequencies.

The diplex filters listed in Table 31 are defined for FDD technology.

Table 31 - FDD CM Diplex Filter Band Edge Frequencies

Split Name	Diplex Filter Start Frequency (Upstream upper band edge) (MHz)	Diplex Filter Stop Frequency (Downstream lower band edge) (MHz)
High-Split	204*	258
UHS-300	300	300 MHz–372 MHz
UHS-396	396	396 MHz–492 MHz
UHS-492	492	492 MHz–606 MHz
UHS-684	684	684 MHz–834 MHz

*Note: For cable modems, the 204 MHz upstream upper band edge is a special case for compatibility with DOCSIS 3.1 high-split networks. In this case, the FDD CM supports the full band 5 MHz to 204 MHz from a single (legacy) TCS, therefore, including the range 85 MHz to 108 MHz. For all other supported diplex filters, the FDD CM's upstream occurs in two TCSs isolated by an additional diplex filter over the range 85 MHz to 108 MHz. For these cases, the range 85 MHz to 108 MHz is unusable for US transmission. This is further described and illustrated in Section 7.3.2.5 and Figure 25. Also, refer to Section 7.3.4 for additional details regarding the TCS and TCS_FDD.

The FDD CM MUST be configurable to operate with any supported upstream upper band edge. The nature and operation of this configurability is vendor-specific. Possible forms of configurability include a hardware switch on the modem housing, a software-controlled diplex filter responsive to OSSI commands, or other forms.

The FDD CM also complies with the following requirements:

- The FDD CM modulator MUST support upstream transmissions from 5 MHz to 204 MHz in a single (legacy) TCS, including the frequency range from 85 MHz to 108 MHz when using a 204 MHz diplex filter and the transmit power requirements in [DOCSIS PHYv3.1].
- The FDD CM modulator MUST support upstream transmissions from 5 MHz to 85 MHz (legacy TCS) and from 108 MHz to the upstream upper band edge (TCS_FDD) when using any of UHS-300, UHS-396, UHS-492, or UHS-684 diplex filter options; in these cases, upstream transmission between 85 MHz and 108 MHz is not required.
- The FDD CM MUST support a minimum of 7 independently configurable OFDMA upstream channels, each occupying a spectrum of up to 96 MHz.
- The FDD CM MUST be capable of transmitting on all upstream channels simultaneously.
- The FDD CM MUST support a minimum of 4 upstream SC-QAM channels in the range of 5 MHz to 85 MHz. The FDD CM MAY support a minimum of 8 upstream SC-QAM channels in the range 5 MHz to 85 MHz. This is the total number of upstream SC-QAM channels, and not additional channels with respect to a DOCSIS 3.1 CM.

7.3.2.4 Upstream FDD Node Spectrum

If a CMTS implements FDD capability, the Node complies with the following requirements, in addition to the requirements of section 7.2.4 of [DOCSIS PHYv3.1]:

- The FDD Node demodulator MUST be capable of receiving upstream transmissions from 5 MHz to 684 MHz.
- The FDD Node MUST support 8 configurable OFDMA upstream channels, each independently configurable for up to 96 MHz. This applies to all OFDMA channels supported by the CMTS, not just UHS FDD OFDMA channels.
- The FDD Node demodulator MUST be capable of receiving upstream transmissions from 5 MHz to 204 MHz when operating in DOCSIS 3.1 high-split operational mode.
- The FDD Node MUST support 2 configurable OFDMA upstream channels, each occupying spectrum of up to 96 MHz when operating in DOCSIS 3.1 high-split operational mode.

7.3.2.5 FDD Channel Band Rules

7.3.2.5.1 Downstream Channel Bandwidth Rules

See [DOCSIS PHYv3.1], section 7.2.5.1.

7.3.2.5.2 Downstream Exclusion Band Rules

See [DOCSIS PHYv3.1], section 7.2.5.2.

7.3.2.5.3 Upstream Channel Bandwidth Rules

See [DOCSIS PHYv3.1], section 7.2.5.3.

7.3.2.5.4 Upstream Exclusions and Unused Subcarriers Rules

See [DOCSIS PHYv3.1], section 7.2.5.4.

7.3.2.5.5 FDD Channel Band Rules

For FDD operation, the extended upstream ranges beyond high-split (204 MHz) is provided for by the use of two separate Transmit Channel Sets (TCSs). As with the FDX US operation, the two TCS are separated/isolated within the FDD CM by a diplex filter over the range 85 MHz to 108 MHz. In addition to the extended FDD US ranges (300 MHz, 396 MHz, 492 MHz and 684 MHz) and the associated diplex filter transition band, there is another diplex filter region in the range of 85 MHz to 108 MHz which is unusable for US transmissions by the FDD CM operating under one of these associated FDD Upstream Allocated Spectrums. Therefore, the FDD CM can transmit legacy (non-FDD OFDM or SC-QAM) US channels over the range 5 MHz to 85 MHz and FDD US channels in the range of 108 MHz up to the chosen/configured US upper band edge.

The 204 MHz (high-split) diplex filter option is included as a special case for compatibility with a legacy DOCSIS 3.1 high-split network and the upstream FDD transmission is achieved using a single TCS, as it is for a DOCSIS 3.1 CM supporting the high-split case at 204 MHz and supporting 65 dBmV TCP capability over the range 5 MHz to 204 MHz.

The largest possible FDD Upstream Allocated Spectrum for FDD upstream channels is 576 MHz (108 MHz to 684 MHz). The upper limit of 684 MHz is derived from starting with the lower band edge of mid-split (108 MHz) and allowing for six OFDMA channels, 96 MHz each. Other FDD Upstream Allocated Spectrum assignments allow for:

- Two 96 MHz OFDMA channels (192 MHz), or
- Three 96 MHz OFDMA channels (288 MHz), or
- Four 96 MHz OFDMA channels (384 MHz).

For each of these extended FDD US cases, the available US spectrum is combined with the range 5 MHz to 85 MHz for non-FDD, legacy US transmissions. These FDD Upstream Allocated Spectrum options are illustrated in Figure 25.

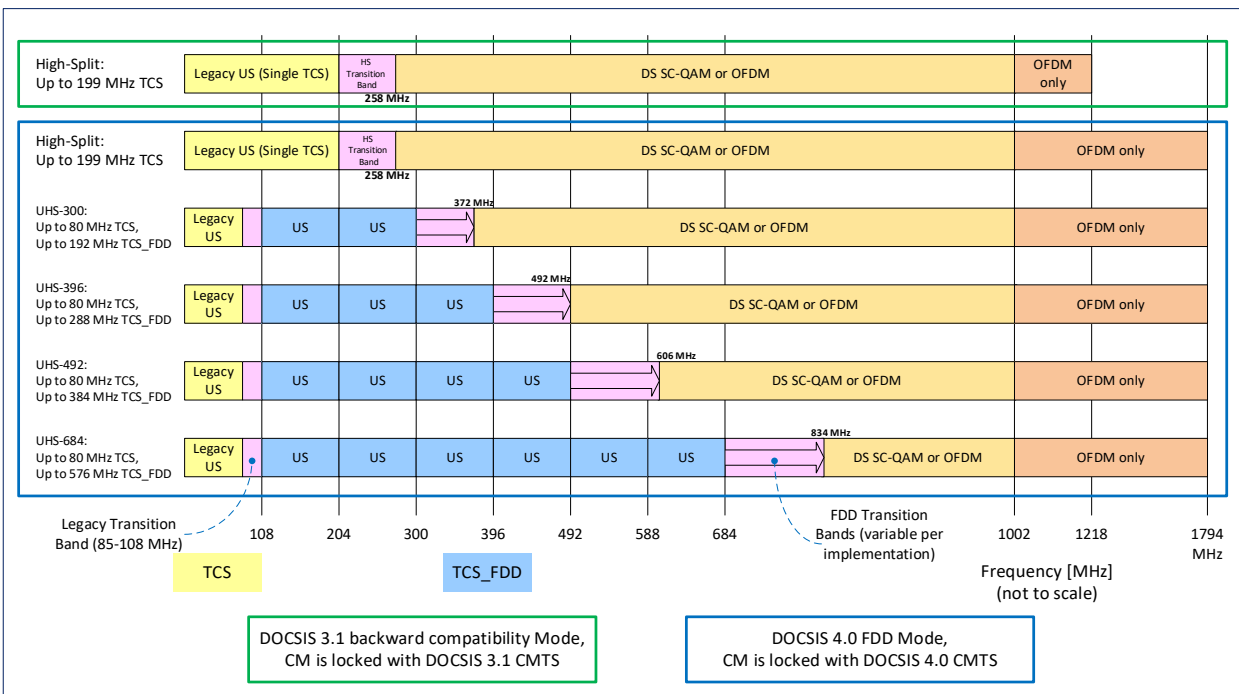

Figure 25 - Configurable FDD Upstream Allocated Spectrum Bandwidths

An FDD CMTS MUST configure the FDD Upstream Allocated Spectrum to contain only US FDD OFDMA channels.

7.3.2.5.5.1 FDD CM Operation in a High-Split Network

A high-split network is defined as an HFC network where legacy DOCSIS technologies exist, and the upstream band extends from 5 MHz to 204 MHz.

If the FDD CM is configured for a 204 MHz diplex filter option, the FDD CM MUST support upstream transmissions from 5 MHz to 204 MHz in legacy DOCSIS 3.1 high-split operational mode. Additional details regarding this operation for the FDD CM is provided in Section 7.3.2.5.5 above.

7.3.2.6 Operation in the FDD Band in Non-Upstream Allocated Spectrum

The FDD CM supports downstream operation starting at the upper frequency edge of the selected diplex filter option as shown in Table 30 and Figure 25.

7.3.2.7 Operation in the FDD Transition Bands

The FDD CM does not operate within the selected diplex transition bands as specified in Table 30 and shown in Figure 25.

7.3.2.8 Operation Above the FDD Transition Band

The FDD CM supports normal DS operation in the spectrum above the FDD transition bands

7.3.3 FDD OFDM Numerology

See [DOCSIS PHYv3.1], section 7.3.

7.3.3.1 Downstream OFDM Numerology

See [DOCSIS PHYv3.1], section 7.3.1.

7.3.3.2 Upstream OFDMA Numerology

See [DOCSIS PHYv3.1], section 7.3.2.

7.3.3.3 Subcarrier Clocking

See [DOCSIS PHYv3.1], section 7.3.3.

7.3.4 Upstream Transmit and Receive

7.3.4.1 Signal Processing Requirements

See [DOCSIS PHYv3.1], section 7.4.1.

7.3.4.2 Time and Frequency Synchronization

See [DOCSIS PHYv3.1], section 7.4.2.

7.3.4.2.1 Channel Frequency Accuracy

This section augments section 7.4.2.1 of [DOCSIS PHYv3.1].

The frequency of the upstream subcarrier clock (or upstream subcarrier spacing) is required to be accurate within 0.4 ppm and each subcarrier frequency accurate within 30 Hz, both relative to the Master Clock reference, and both for five sigma of the upstream OFDMA transmissions, for subcarrier frequencies up to 684 MHz, depending on the selected diplex filter option. The measurements of the frequency of the upstream subcarrier clock, and the subcarrier frequencies, are averaged over the duration of an upstream single frame grant. A constant temperature is maintained during the measurements within a range of 20 °C ± 2 °C. A minimum warm up time of 30 minutes occurs before the CM frequency measurements are made.

7.3.4.2.2 Channel Timing Accuracy

See [DOCSIS PHYv3.1], section 7.4.2.2.

7.3.4.2.3 Modulation Timing Jitter

See [DOCSIS PHYv3.1], section 7.4.2.3.

7.3.4.3 Forward Error Correction

See [DOCSIS PHYv3.1], section 7.4.3.

7.3.4.4 Data Randomization

See [DOCSIS PHYv3.1], section 7.4.4.

7.3.4.5 Time and Frequency Interleaving and De-interleaving

See [DOCSIS PHYv3.1], section 7.4.5.

7.3.4.6 Mapping of Bits to Cell Words

See [DOCSIS PHYv3.1], section 7.4.6.

7.3.4.7 Mapping and Demapping Bits to/from QAM Subcarriers

See [DOCSIS PHYv3.1], section 7.4.7.

7.3.4.8 REQ Messages

See [DOCSIS PHYv3.1], section 7.4.8.

7.3.4.9 IDFT

See [DOCSIS PHYv3.1], section 7.4.9.

7.3.4.10 Cyclic Prefix and Windowing

See [DOCSIS PHYv3.1], section 7.4.10.

7.3.4.11 Burst Timing Convention

See [DOCSIS PHYv3.1], section 7.4.11.

7.3.4.12 Fidelity Requirements

For devices operating in FDD mode, this section augments the requirements of section 7.4.12 of [DOCSIS PHYv3.1] and corresponding subsections unless otherwise noted.

If the FDD CM supports and is configured to operate with an upstream upper band edge of 204 MHz, the FDD CM MUST adhere to the Fidelity Requirements of DOCSIS3.1 in [DOCSIS PHYv3.1], section 7.4.12.

In all other cases, when the FDD CM is configured to an upper upstream band edge higher than 204 MHz, the FDD CM operates with two transmission channel sets similar to what is defined in the FDX mode of operation: one transmit channel set within 5 MHz to 85 MHz legacy band (TCS), and the other for OFDMA channels in the frequency region above 108 MHz (TCS_FDD).

An FDD CM's Transmit Channel Set in the FDD spectrum (TCS_FDD), 108 MHz to the configured upstream upper band edge, is the set of OFDMA channels that can be transmitted by the CM in that band.

The FDD CM MUST comply with the Fidelity Requirements in this section.

7.3.4.12.1 Upstream Fidelity Measurement Framework

The Upstream Fidelity Measurement Framework for the FDD Band illustrated in Figure 26 - FDD Cable Modem Upstream Power and Fidelity Measurements at Interface F is referenced for upstream channel power requirements that follow.

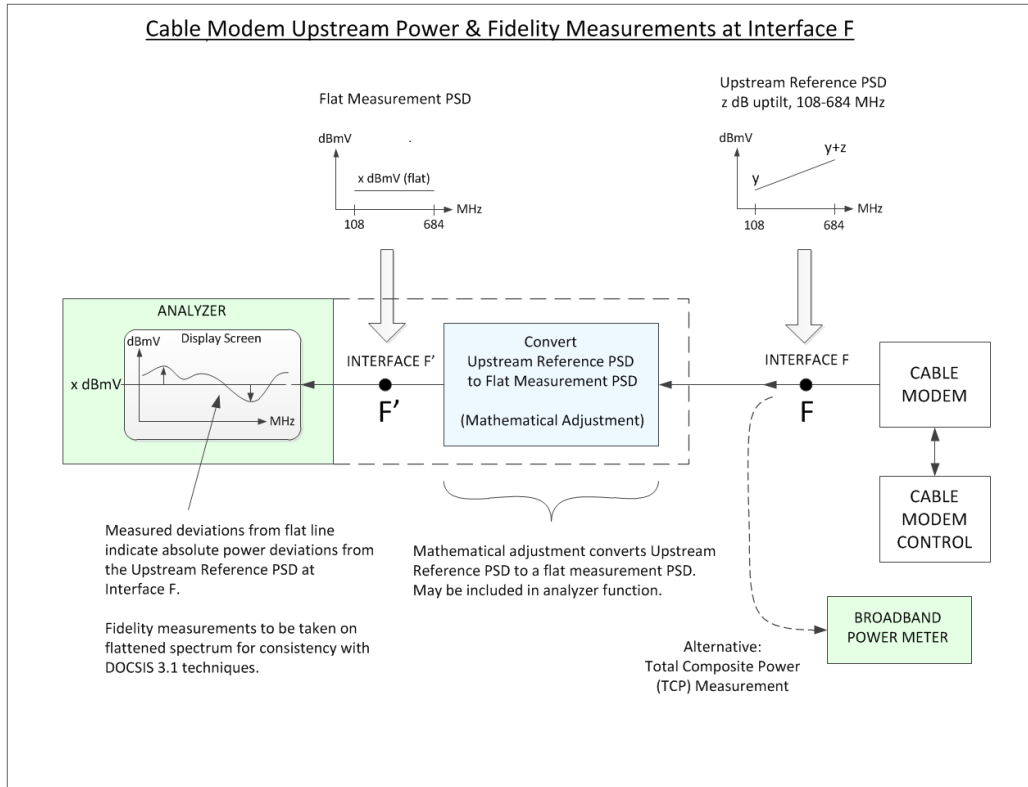

Figure 26 - FDD Cable Modem Upstream Power and Fidelity Measurements at Interface F

With $BW_{\text{OFDMA-FDD}}$ being the combined Occupied Bandwidth of the OFDMA channel(s) in its TCS_FDD, the FDD CM is said to have $N_{\text{eq-FDD}} = \text{ceil}(BW_{\text{OFDMA-FDD}}(\text{MHz})/1.6 \text{ MHz})$ "equivalent DOCSIS channels" in its TCS_FDD.

An FDD CM that is operating in UHS-684 mode MUST be capable of transmitting a maximum total average output power of at least 65 dBmV at interface F for the combined power of TCS_FDD and legacy TCS.

The FDD CM MAY be capable of transmitting a total average output power greater than 65 dBmV at interface F.

An FDD CM that is operating in UHS-300 mode MUST be capable of transmitting a maximum total average output power of at least 58.6 dBmV in the FDD Band.

An FDD CM that is operating in UHS-396 mode MUST be capable of transmitting a maximum total average output power of at least 61.3 dBmV in the FDD Band.

An FDD CM that is operating in UHS-492 mode MUST be capable of transmitting a maximum total average output power of at least 63.6 dBmV in the FDD Band.

An FDD CM that is operating in UHS-684 mode MUST be capable of transmitting a maximum total average output power of at least 64.5 dBmV in the FDD Band.

An FDD CM that is operating in UHS-300 mode MAY be capable of transmitting a maximum total average output power greater than 58.6 dBmV in the FDD Band.

An FDD CM that is operating in UHS-396 mode MAY be capable of transmitting a maximum total average output power greater than 61.3 dBmV in the FDD Band.

An FDD CM that is operating in UHS-492 mode MAY be capable of transmitting a maximum total average output power greater than 63.6 dBmV in the FDD Band.

An FDD CM that is operating in UHS-684 mode MAY be capable of transmitting a maximum total average output power greater than 64.5 dBmV in the FDD Band.

The FDD CM MUST be capable of transmitting a total average output power of 55 dBmV in the legacy US (5 MHz to 85 MHz) band when operating in FDD mode.

Interface F has a requirement on the maximum TCP (total composite power) which is 64.5 dBmV, realized when the FDD modulated spectrum is at the maximum which is 570 MHz, and reduces from 64.5 dBmV as modulated spectrum reduces.

At Interface F, the Upstream Reference PSD is defined, which is a line in dBmV for the y-axis and in linear frequency for the x-axis that passes through the points 33.0 dBmV/1.6 MHz centered at 108.8 MHz and 43.0 dBmV/1.6 MHz centered at 683.2 MHz for a CM that is operating in UHS-684 split. For a CM operating in UHS-300, UHS-396, or UHS-492, the Upstream Reference PSD is 3 dB higher, and it is a line in dBmV for the y-axis and in linear frequency for the x-axis that passes through the points 36.0 dBmV/1.6 MHz centered at 108.8 MHz and 46.0 dBmV/1.6 MHz centered at 683.2 MHz.

At Interface F, the Dynamic Range Window for FDD (DRW_FDD) is defined, which is the result of adjustment relative to the Upstream Reference PSD, lowered by the amount commanded by the FDD CMTS. The DRW_FDD is managed in the FDD spectrum in a similar manner as the DRW is managed in the legacy DOCSIS 3.1 upstream spectrum, but DRW_FDD and DRW are different. DOCSIS 3.1 CMs are still managed with the DOCSIS 3.1 DRW. DRW_FDD does not apply to DOCSIS 3.1 CMs.

Channel power adjustments within the FDD spectrum are managed similarly to the channel power adjustments in the legacy DOCSIS 3.1 upstream spectrum, which adjusts each individual channel PSD at or below the top of the DRW_FDD. Additionally, the individual channel PSD for a CM operating in any of the FDD modes can be adjusted above the top of the DRW_FDD by up to 1.5 dB within the FDD Band (i.e., $P_{\text{limit-FDD}}$ is specified in Section 7.3.4.12.2) when the top of the DRW-FDD is at $P_{\text{ref-FDD}}$.

Figure 26 illustrates the measurement for channel reported power accuracy and MER and spurious emissions for signals in the FDD spectrum. The test setup defining the measurements provides that a signal with the Upstream Reference PSD at Interface F has a flat PSD at Interface F'.

7.3.4.12.2 FDD Upstream Reference PSD

The channel reported power for an FDD CM for channels in the FDD spectrum are reported relative to the Upstream Reference PSD. The channel commanded power (per 1.6 MHz) for a channel at Interface F is, by definition, the channel power adjustments up or down from the Upstream Reference PSD.

The "equivalent channel power" of an FDD OFDMA channel is the average power at Interface F' of the OFDMA subcarriers of the channel normalized to 1.6 MHz bandwidth and referenced to the Upstream Reference PSD at Interface F'. This equivalent channel power of an FDD OFDMA channel is denoted as $P_{1.6r, n\text{-FDD}}$. The TCS_FDD has zero to six OFDMA channels, but also is described as having $N_{\text{eq-FDD}}$ number of equivalent DOCSIS channels.

Each channel in the TCS_FDD is described by its reported power $P_{1.6r, n\text{-FDD}}$, which is the channel power when it is fully granted and normalized to 1.6 MHz. The relation of the reported power to the expected true power of a fully granted channel is a function of the number of active subcarriers in the channel and their frequency. The reported power for each channel is referenced to Interface F' to simplify the upstream power management at the FDD CMTS, which is generally expected to operate with a flat received PSD.

For an FDD CM, $P_{\text{ref-FDD}}$ is a parameter which is a function of frequency and is the power in dBmV in 1.6 MHz of subcarriers with no Pre-Equalization. $P_{\text{ref-FDD}}$ has a slope of (10 dB/360 slots of 1.6 MHz in the FDD Band) dBmV/1.6 MHz, and a total variation of 10.0 dB across 108 MHz to 684 MHz. For a CM that is operating in UHS-684, $P_{\text{ref-FDD}}(108.8 \text{ MHz}) = 33.0 \text{ dBmV}/1.6 \text{ MHz}$ and $P_{\text{ref-FDD}}(683.2 \text{ MHz}) = 43.0 \text{ dBmV}/1.6 \text{ MHz}$. This corresponds to 64.5 dBmV TCP with 570 MHz modulated spectrum in the TCS_FDD ($N_{\text{eq-FDD}} = 357$). For a CM that is operating in UHS-300, UHS-396, or UHS-492, $P_{\text{ref-FDD}}(108.8 \text{ MHz}) = 36.0 \text{ dBmV}/1.6 \text{ MHz}$ and $P_{\text{ref-FDD}}(683.2 \text{ MHz}) = 46.0 \text{ dBmV}/1.6 \text{ MHz}$. For UHS-300, this corresponds to 58.6 dBmV TCP with 190 MHz modulated spectrum in the TCS_FDD ($N_{\text{eq-FDD}} = 119$). For UHS-396, this corresponds to 61.3 dBmV TCP with

285 MHz modulated spectrum in the TCS_FDD ($N_{eq-FDD} = 179$). For UHS 492, this corresponds to 63.6 dBmV TCP with 380 MHz modulated spectrum in the TCS_FDD ($N_{eq-FDD} = 238$). Note that there are no upstream SC-QAM channels in the FDD band.

Table 32 summarizes the DOCSIS 4.0 CM Upstream Reference PSD, maximum TCP, spectral tilt, and modulated spectrum at each of the FDD modes as shown in Figure 26.

Table 32 -Upstream Reference PSD, TCP, and Spectral Tilt Values for Different FDD Modes

FDD Mode	y (108.8 MHz)	y+z (683.2 MHz)	Spectral Tilt for Fidelity Req.	Maximum TCP	Modulated FDD Spectrum
UHS-300	36 dBmV/1.6 MHz	46 dBmV/1.6 MHz	10 dB	58.6 dBmV	190 MHz
UHS-396	36 dBmV/1.6 MHz	46 dBmV/1.6 MHz	10 dB	61.3 dBmV	285 MHz
UHS-492	36 dBmV/1.6 MHz	46 dBmV/1.6 MHz	10 dB	63.6 dBmV	380 MHz
UHS-684	33 dBmV/1.6 MHz	43 dBmV/1.6 MHz	10 dB	64.5 dBmV	570 MHz
UHS-684	34.3 dBmV/1.6 MHz	42.3 dBmV/1.6 MHz	8 dB	64.5 dBmV	570 MHz
UHS-684	31.6 dBmV/1.6 MHz	43.6 dBmV/1.6 MHz	12 dB ¹	64.5 dBmV	570 MHz

Table Note:
 Note 1. Fidelity requirements are met with 1 dB additional allowance for MER, inband and out-of-band spurious emissions compared to the 10 dB uptilt case.

For all four FDD split options (UHS-300, UHS-396, UHS-492, and UHS-684), fidelity requirements apply with $P_{ref-FDD}$ for the transmit power spectral density, with 10 dB uptilt and no other channel adjustments or Pre-Equalization. For the UHS-684 split option only, fidelity requirements also apply with 8 dB uptilt (and no other channel adjustments or Pre-Equalization beyond accomplishing the slope). For the UHS-684 split option only, fidelity requirements with 1 dB additional allowance for spurious emissions, MER and Inband (compared to the 10 dB uptilt case) apply with 12 dB uptilt (and no other channel adjustments or Pre-Equalization beyond accomplishing the slope).

$P_{limit-FDD}$ is the maximum power per channel, increased from $P_{ref-FDD}$, for which only gradual degradation of fidelity requirements may be expected. $P_{limit-FDD}$ is 1.5 dB for upstream channels with no modulated spectrum above 300 MHz and is 1 dB for channels with any modulated spectrum above 300 MHz. Note that although some channels may be commanded above $P_{ref-FDD}$, and fidelity requirements may still apply, if the TCP exceeds P_{maxFDD} , then fidelity requirements do not apply.

The maximum power per any individual subcarrier, increased from $P_{ref-FDD}$, for which gradual degradation of fidelity requirements may be expected are given as follows: with any subcarrier power commanded more than 3 dB higher than $P_{ref-FDD}$, in any channel which has no modulated spectrum above 300 MHz; with any subcarrier power commanded more than 2.5 dB higher than $P_{ref-FDD}$, in any channel which has no modulated spectrum above 492 MHz but some modulated spectrum above 300 MHz; or with subcarrier power commanded more than 2.0 dB higher than $P_{ref-FDD}$, in any channel which has some modulated spectrum above 492 MHz. Note that although some subcarriers may be commanded above $P_{ref-FDD}$, and fidelity requirements may still apply, if the TCP exceeds P_{maxFDD} then fidelity requirements do not apply.

7.3.4.12.3 Maximum Scheduled Minislots

Maximum Scheduled Minislots is not supported for FDD CMs operating in FDD mode.

7.3.4.12.4 FDD Transmit Power Requirements

The transmit power is a function of the number and occupied bandwidth of the OFDMA channels in the TCS_FDD, or equivalently the amount of TCS_FDD modulated spectrum and the frequency of the modulated spectrum. The highest value of the total power output in the FDD spectrum of the FDD CM, P_{maxFDD} , is 64.5 dBmV and occurs when all the FDD CM's potential FDD spectrum (108 MHz to 684 MHz) is occupied with OFDMA channels in its TCS_FDD and these are fully granted to the FDD CM, and all channels are commanded to 0 dB channel power. The FDD Upstream Reference PSD is denoted as $P_{ref-FDD}$ and is a function of frequency as defined in Section 7.3.4.12.2. When the TCS_FDD occupies a subset of the potential FDD spectrum, the TCP is reduced from 64.5 dBmV. The top of the Dynamic Range Window of the OFDMA FDD spectrum can be reduced from $P_{ref-FDD}$ by

adjusting $P_{\text{load_min_set-FDD}}$ to a value greater than 0 dB. The OFDMA FDD spectrum's n^{th} channel power can be raised by up to 1.5 dB within the FDD Band ($P_{\text{limit-FDD}}$) when the top of the DRW_FDD is at $P_{\text{ref-FDD}}$, or reduced for any setting of the DRW_FDD. For example, the n^{th} channel power can be reduced by setting its $P_{1.6r_n\text{-FDD}}$ below 0 dB (negative), thereby reducing all the channel subcarriers from their power that was based on $P_{\text{ref-FDD}}$ and $P_{1.6r_n\text{-FDD}} = 0$ dB. There are limits on the amount of reduction as described below. This adjustability in channel power ensures that each channel can be set to a power range (within the DRW_FDD) between its maximum power, $P_{\text{ref-FDD}} - P_{\text{load_min_set-FDD}}$, or up to 1.5 dB higher within the FDD Band ($P_{\text{limit-FDD}}$) when $P_{\text{load_min_set-FDD}} = 0$, and minimum power, $P_{1.6low\text{-FDD}}$, and that any possible transmit grant combination can be accommodated without exceeding the transmit power capability of the CM.

For FDD, $P_{1.6low\text{-FDD}} = P_{1.6min\text{-FDD}} = -15$ dB for UHS-684 or $P_{1.6low\text{-FDD}} = P_{1.6min\text{-FDD}} = -18$ dB for UHS-300, UHS-396, and UHS-492. Boosted pilots are not supported in the FDD channels. Before completion of Fine Ranging, the FDD CM has no need to transmit with power per subcarrier which is lower than indicated by $P_{1.6low\text{-FDD}}$. These transmissions are prior to any data grant transmissions in the FDD band from the CM and as such the CM analog and digital gain balancing may be optimized for these transmissions.

When $P_{\text{load_min_set-FDD}}$ is 0 dB, the FDD CMTS SHOULD NOT command the CM to set $P_{1.6r_n\text{-FDD}}$ on any channel in the TCS_FDD between 108 MHz and 300 MHz to a value more than 1.5 dB above the top of the DRW_FDD, or any channel in the TCS_FDD above 300 MHz, to a value more than 1 dB above the top of the DRW_FDD, or lower than the bottom of the DRW_FDD. When $P_{\text{load_min_set-FDD}}$ is greater than 0 dB, the FDD CMTS SHOULD NOT command the CM to set $P_{1.6r_n\text{-FDD}}$ on any channel in the TCS_FDD to a value more than 0 dB above the top of the DRW_FDD, or lower than the bottom of the DRW_FDD.

If the FDD CMTS commands the FDD CM to exceed the top of the DRW_FDD, fidelity and performance requirements on the FDD CM do not apply, except for the following two narrow cases, which are applicable in UHS-684 operation mode only; with the 8 dB uptilt case spurious emissions and MER requirements are the same as with the 10 dB uptilt specified case; and with the 12 dB uptilt receiving 1 dB relaxation for spurious emissions and MER:

- 8 dB uptilt, 64.5 dBmV TCP: 1.3 dB higher (34.3 dBmV / 1.6 MHz) at 108.8 MHz and 0.7 dB lower (42.3 dBmV / 1.6 MHz) at 683.2 MHz.
- 12 dB uptilt, 64.5 dBmV TCP: 1.4 dB lower (31.6 dBmV / 1.6 MHz) at 108.8 MHz and 0.6 dB higher (43.6 dBmV / 1.6 MHz) at 683.2 MHz.

Table 32 (above) summarizes the FDD upstream Reference PSD for different amount of spectral tilt as shown in Figure 26 (above).

If $P_{\text{load_min_set-FDD}}$ is more than 0 dB, and the FDD CM is commanded to transmit on any channel in the TCS_FDD at a value higher than the top of the DRW_FDD or lower than the bottom of the DRW_FDD, the cable modem indicates an error condition by setting the appropriate bit in the SID field of RNG-REQ messages for that channel until the error condition is cleared as described in [DOCSIS MULPIv4.0].

If $P_{\text{load_min_set-FDD}}$ is 0 dB, and the FDD CM is commanded to transmit on any channel in the TCS_FDD at a value more than 1.5 dB higher than the top of the DRW_FDD for channels in 108 MHz to 300 MHz or more than 1 dB higher than the top of the DRW_FDD for channels higher than 300 MHz, or lower than the bottom of the DRW_FDD, the cable modem indicates an error condition by setting the appropriate bit in the SID field of RNG-REQ messages for that channel until the error condition is cleared as described in [DOCSIS MULPIv4.0].

The FDD CMTS sends transmit power level commands and pre-equalizer coefficients to the FDD CM as described in [DOCSIS MULPIv4.0] to compensate for upstream plant conditions. The top edge of the DRW_FDD is set to a level, $P_{-1.6load_min_set-FDD}$, close to the highest $P_{1.6r_n\text{-FDD}}$ transmit channel to optimally load the DAC. In conditions of tilt significantly different than the nominal 10 dB tilt, some of the channels will be sent commands to transmit at lower $P_{1.6r_n\text{-FDD}}$ values that use up a significant portion of the DRW_FDD, and perhaps exceed the top of the DRW_FDD. Additionally, the pre-equalizer coefficients of the OFDMA channels will also compensate for plant tilts away from the nominal 10 dB. The FDD CMTS normally administers a DRW_FDD of 10 dB [DOCSIS MULPIv4.0] which is sufficient to accommodate plant tilts of up to +2 dB to -2 dB different from the specified tilt cases, 8 dB and 12 dB, and to accommodate plant flatness variations and loss variations as a function of frequency. Since the fidelity requirements are specified in flat frequency conditions at Interface F' relative to the top of the DRW_FDD, it is desirable to maintain FDD CM transmission power levels as close to the top of the DRW_FDD as

possible. When conditions change sufficiently to warrant it, a global reconfiguration time should be granted and the top of the DRW_FDD adjusted to maintain the best transmission fidelity and optimize system performance.

7.3.4.12.4.1 FDD Transmit Power Detailed Requirements

For FDD CMs operating in FDD mode, Multiple Transmit Channel Mode is always enabled.

The FDD CM MUST support varying the amount of transmit power.

Requirements are presented for 1) range of reported transmit power per channel; 2) step size of power commands; 3) step size accuracy (actual change in output power per channel compared to commanded change); and 4) absolute accuracy of FDD CM output power per channel. The protocol by which power adjustments are performed is defined in [DOCSIS MULPIv4.0].

The FDD CM MUST support such adjustments, commanded by the CMTS, within the ranges of tolerances described below.

An FDD CM MUST confirm that the transmit power per channel limits are met after a RNG-RSP is received for each of the FDD CM's active channels that is referenced and indicate that an error has occurred in the next RNG-REQ messages for the channel until the error condition is cleared [DOCSIS MULPIv4.0].

Sometime after registration the FDD CMTS can initialize FDD operations for an FDD CM. During this process, the CM is assigned to a TG and receives FDD channel assignment via the Dynamic Bonding Request (DBC) mechanism. The group of active channels in the FDD Band assigned to an FDD CM is known as the CM's FDD Transmit Channel Set (TCS_FDD). If the FDD CMTS needs to add, remove, or replace channels in the FDD CM's TCS_FDD, it uses the DBC-REQ Message with Transmit Channel Configuration encodings to define the new desired TCS_FDD. The set of channels actually bursting upstream from an FDD CM at any time could be all or a subset of the active channels on that FDD CM. Often one or all active channels on an FDD CM will not be bursting, but such quiet channels are still active channels for that FDD CM.

Transmit power per channel is defined as the average RF power in the occupied bandwidth (channel width), assuming equally likely QAM symbols, relative to the Upstream Reference PSD, measured at Interface F' of Figure 26 as detailed below. Reported transmit power for an OFDMA channel is expressed as $P_{1.6r_n\text{-FDD}}$ and is defined as the average RF power of the FDD CM transmission in the OFDMA channel, relative to the Upstream Reference PSD at Interface F' when transmitting in a grant composed of 64 25 kHz subcarriers or 32 50 kHz subcarriers. Total transmit power is defined as the sum of the transmit power per channel of each channel transmitting a burst at a given time.

The FDD CM MUST maintain its actual transmitted power per equivalent channel to within ± 2 dB of the reported power, $P_{1.6r_n\text{-FDD}}$, with pre-equalization off, taking into account symbol constellation values.

The FDD CM MUST allow its target transmit power per channel to vary over the range specified in Section 7.2.4.12.4.

The fidelity requirements do not apply when the FDD CM is commanded to transmit at power levels which exceed the top of the DRW_FDD in all four FDD splits (UHS-300, UHS-396, UHS-492, and UHS-684), except for the two narrow cases 8 dB up tilt and 12 dB up tilt in the UHS-684 split option.

The transmit channel loading $P_{1.6load\text{-FDD}}$ describes how close the transmit power level for a particular channel is to the top of the DRW_FDD. Let $P_{1.6load\text{-FDD}} = P_{ref\text{-FDD}} - P_{1.6r_n\text{-FDD}}$, for each channel, using the definitions for $P_{ref\text{-FDD}}$ and $P_{1.6r_n\text{-FDD}}$ in the following subsections of Section 7.3.4.12.5. The channel corresponding to the minimum value of $P_{1.6load\text{-FDD}}$ is called the highest loaded channel, and its value is denoted as $P_{1.6load_1\text{-FDD}}$, in this specification even if there is only one channel in the FDD Transmit Channel Set (TCS_FDD). A channel with high loading has a low $P_{1.6load_i\text{-FDD}}$ value; the value of $P_{1.6load_n\text{-FDD}}$ is analogous to an amount of back-off for an amplifier from its max power output, except that it is normalized to 1.6 MHz of bandwidth. A channel has lower power output when that channel has a lower loading (more back-off) and thus a higher value of $P_{1.6load_i\text{-FDD}}$. Note that the highest loaded channel is not necessarily the channel with the highest transmit power at Interface F' in Figure 26 since a channel's max power at Interface F' depends on the bandwidth of the channel. The channel with the second lowest value of $P_{1.6load\text{-FDD}}$ is denoted as the second highest loaded channel, and its loading value is denoted as $P_{1.6load_2\text{-FDD}}$; the channel with the i th lowest value of $P_{1.6load\text{-FDD}}$ is the i th highest loaded channel, and its loading value is denoted as $P_{1.6load_i\text{-FDD}}$.

$P_{1.6load_min_set_FDD}$ defines the upper end of the DRW_FDD for the FDD CM with respect to P_{ref_FDD} . $P_{1.6load_min_set_FDD}$ will normally limit the maximum power possible for each active channel to a value less than P_{ref_FDD} , but a commanded power adjustment can result in a violation of the DRW_FDD, in which case the FDD CM compliance with the fidelity requirements is not enforced, with two narrow exceptions for 8 dB up tilt and 12 dB up tilt described in the previous section. $P_{1.6load_min_set_FDD}$ is a value commanded to the FDD CM from the FDD CMTS when the FDD CM is given a TCC in Registration and RNG-RSP messages after Registration as described in [DOCSIS MULPIv4.0]. $P_{1.6load_min_set_FDD}$, $P_{1.6load_n_FDD}$, P_{ref_FDD} , P_{limit_FDD} , $P_{1.6r_n_FDD}$, etc., are defined for DOCSIS FDD modems operating on an FDD CMTS. See Section 7.2.4.12.4 for a summary of these and other terms related to transmit power.

The FDD CMTS SHOULD command the FDD CM to use a value for $P_{1.6load_min_set_FDD}$ such that $P_{ref_FDD} - P_{1.6load_min_set_FDD} \geq P_{1.6low_n_FDD}$ for each active channel, with allowance for higher channel power up to P_{limit_FDD} in some channels, as long as P_{max_FDD} is maintained (to support different up tilt than 10 dB), or equivalently:

$$0 \leq P_{1.6load_min_set_FDD} \leq P_{ref_FDD} - P_{1.6low_n_FDD}$$

A value is computed, $P_{1.6low_multi_FDD}$, which sets the lower end of the transmit power DRW_FDD for that channel, given the upper end of the range which is determined by $P_{1.6load_min_set_FDD}$.

$$P_{1.6low_multi_FDD} = \max\{P_{ref_FDD} - P_{1.6load_min_set_FDD} - 10 \text{ dB}, P_{ref_FDD} - 15 \text{ dB}\} \text{ for UHS-684}$$

$$P_{1.6low_multi_FDD} = \max\{P_{ref_FDD} - P_{1.6load_min_set_FDD} - 10 \text{ dB}, P_{ref_FDD} - 18 \text{ dB}\} \text{ for UHS-300, UHS-396, or UHS-492}$$

The effect of $P_{1.6low_multi_FDD}$ is to restrict the dynamic range required (or even allowed) by an FDD CM across its multiple channels, when operating with multiple active channels.

The FDD CMTS SHOULD command a $P_{1.6r_n_FDD}$ consistent with the $P_{1.6load_min_set_FDD}$ assigned to the FDD CM and with the following limits (with allowance up to P_{limit_FDD} rather than P_{ref_FDD} to accommodate different up tilt than 10 dB):

$$P_{1.6load_min_set_FDD} \leq P_{ref_FDD} - P_{1.6r_n_FDD} \leq P_{1.6load_min_set_FDD} + 10 \text{ dB}$$

and the equivalent:

$$P_{ref_FDD} - (P_{1.6load_min_set_FDD} + 10 \text{ dB}) \leq P_{1.6r_n_FDD} \leq P_{ref_FDD} - P_{1.6load_min_set_FDD}$$

When the FDD CMTS sends a new value of $P_{1.6load_min_set_FDD}$ to the FDD CM, there is a possibility that the FDD CM will not be able to implement the change to the new value immediately, because the FDD CM may be in the middle of bursting on one or more of its upstream channels at the instant the command to change $P_{1.6load_min_set_FDD}$ is received at the FDD CM. Some amount of time may elapse before the FDD CMTS grants global reconfiguration time to the FDD CM. Similarly, commanded changes to $P_{1.6r_n_FDD}$ may not be implemented immediately upon reception at the FDD CM if the nth channel is bursting. Commanded changes to $P_{1.6r_n_FDD}$ may occur simultaneously with the command to change $P_{1.6load_min_set_FDD}$.

The FDD CMTS SHOULD NOT issue a change in $P_{1.6load_min_set_FDD}$ after commanding a change in $P_{1.6r_n_FDD}$ until after also providing a sufficient reconfiguration time on the nth channel.

The FDD CMTS SHOULD NOT issue a change in $P_{1.6load_min_set_FDD}$ after commanding a prior change in $P_{1.6load_min_set_FDD}$ until after also providing a global reconfiguration time for the first command.

The FDD CMTS SHOULD NOT issue a change in $P_{1.6r_n_FDD}$ until after providing a global reconfiguration time following a command for a new value of $P_{1.6load_min_set_FDD}$ and until after providing a sufficient reconfiguration time on the nth channel after issuing a previous change in $P_{1.6r_n_FDD}$.

In other words, the FDD CMTS is to avoid sending consecutive changes in $P_{1.6r_n_FDD}$ and/or $P_{1.6load_min_set_FDD}$ to the FDD CM without a sufficient reconfiguration time for instituting the first command.

When a concurrent new value of $P_{1.6load_min_set_FDD}$ and change in $P_{1.6r_n_FDD}$ are commanded, the FDD CM MAY wait to apply the change in $P_{1.6r_n_FDD}$ at the next global reconfiguration time (i.e., concurrent with the institution of the new value of $P_{1.6load_min_set_FDD}$) rather than applying the change at the first sufficient reconfiguration time of the nth channel. The value of $P_{1.6load_min_set_FDD}$ which applies to the new $P_{1.6r_n_FDD}$ is the concurrently commanded $P_{1.6load_min_set_FDD}$ value.

If the change to $P_{1.6r_n_FDD}$ falls outside the DRW_FDD of the old $P_{1.6load_min_set_FDD}$, then the FDD CM MUST wait for the global reconfiguration time to apply the change in $P_{1.6r_n_FDD}$.

The FDD CMTS SHOULD NOT command the FDD CM to decrease the per-channel transmit power if such a command would cause $P_{1.6load_n_FDD}$ for that channel to drop below $P_{1.6load_min_set_FDD}$.

Note that the FDD CMTS can allow small changes of power in the FDD CM's highest loaded channel without these fluctuations impacting the transmit power dynamic range with each such small change. This is accomplished by setting $P_{1.6load_min_set_FDD}$ to a smaller value than normal, and fluctuation of the power per channel in the highest loaded channel is expected to wander.

The FDD CMTS MUST NOT command a change of per channel transmit power or Pre-Equalization which could result in exceeding the CM's P_{maxFDD} in the FDD Band.

If the CMTS improperly commands the FDD CM to exceed P_{maxFDD} , the FDD CM informs the FDD CMTS of the error as described in [DOCSIS MULPIv4.0].

The FDD CMTS SHOULD NOT command a change of per channel transmit power which would result in $P_{1.6r_n_FDD}$ falling below the DRW_FDD , $P_{1.6r_n_FDD} < P_{1.6low_multi_FDD}$.

The FDD CMTS SHOULD NOT command a change in $P_{1.6load_min_set_FDD}$ such that existing values of $P_{1.6r_n_FDD}$ would fall outside the new DRW_FDD .

The following paragraphs define the FDD CM and FDD CMTS behavior in cases where there are DRW_FDD violations due to addition of a new channel with incompatible parameters without direct change of $P_{1.6r_n_FDD}$ or $P_{1.6load_min_set_FDD}$.

When adding a new active channel to the transmit channel set, the new channel's power is calculated according to the offset value defined in TLV 46.8.4 [DOCSIS MULPIv4.0], if it is provided.

The FDD CMTS SHOULD NOT set an offset value that will result in a $P_{1.6r_n_FDD}$ for the new channel outside the DRW_FDD .

In the absence of TLV 46.8.4, the new channel's power is initially set by the FDD CM at the minimum allowable power, i.e., the bottom of the DRW_FDD .

The FDD CM MUST maintain its actual transmitted power per every minislots within a burst constant to within 0.1 dB peak to valley even in the presence of power changes on other active channels.

The 0.1 dB peak to valley does not include amplitude variation theoretically present in the signal (e.g., varying QAM constellations, transmit window). Specifically, within a continuous burst of duration up to n frames (1 millisecond), for each minislots participating in the burst and while the minislots is actively used for transmission, a constant power has to be maintained in that minislots within 0.1 dB peak to valley, even in the presence of a transmission starting or stopping on other minislots and other active channels.

The FDD CM MUST support the transmit power calculations defined in Section 7.3.4.12.5, FDD Transmit Power Calculations.

7.3.4.12.5 FDD Transmit Power Calculations

The FDD CM determines its target transmit power per channel $P_{1.6t_n_FDD}$, as follows, for each channel which is active. Define for each active channel, for example, upstream channel n: $P_{1.6c_n_FDD}$ = Commanded Power for channel n. (TLV-17 in RNG-RSP).

$P_{1.6r_n_FDD}$ = reported power level (dBmV) of the FDD CM for channel n

P_{limit_FDD} = 1.5 dB for channels with no modulated spectrum above 300 MHz and 1.0 dB for channels with any modulated spectrum above 300 MHz

The FDD CM updates its reported power per channel in each channel by the following steps:

1. $\Delta P = P_{1.6c_n_FDD} - P_{1.6r_n_FDD}$
2. $P_{1.6r_n_FDD} = P_{1.6r_n_FDD} + \Delta P$ // Add power level adjustment (for each channel) to reported power level for each channel.

The FDD CMTS SHOULD ensure the following:

1. $P_{1.6r_n\text{-FDD}} \leq P_{\text{limit-FDD}}$, when $P_{1.6\text{load_min_set-FDD}} = 0$ //Clip at max power limit per channel unless the FDD CMTS accommodates a need to increase the PSD for the channel in which case the fidelity performance of the FDD CM is potentially degraded.
2. $P_{1.6r_n\text{-FDD}} \geq P_{1.6\text{low_n-FDD}}$ //Clip at min power limit per channel.
3. $P_{1.6r_n\text{-FDD}} \geq P_{1.6\text{low_multi-FDD}}$ //Power per channel from this command would violate the set DRW-FDD.
4. $P_{1.6r_n\text{-FDD}} \leq P_{1.6\text{load_min_set-FDD}}$, when $P_{1.6\text{load_min_set-FDD}} > 0$ //Power per channel from this command violates the set DRW_FDD, but the CMTS could accommodate a need to increase the PSD for the channel in which case the fidelity performance of the CM is potentially degraded.

For OFDMA, the CM then transmits each data subcarrier with target power:

$$P_{t_sc_i} = P_{1.6r_n\text{-FDD}} + \text{Pre-Eq}_i - 10\log_{10}(\text{number_of subcarriers in 1.6 MHz } \{32 \text{ or } 64\})$$

where Pre-Eq_i is the magnitude of the i^{th} subcarrier pre-equalizer coefficient (dB).

That is, the reported power for channel n, normalized to 1.6 MHz, plus the pre-equalization for the subcarrier, less a factor taking into account the number of subcarriers in 1.6 MHz.

$\text{Probe}_{\text{delta_n-FDD}}$ for the n^{th} FDD OFDMA channel is the change in subcarrier power for probes compared to subcarrier power for data depending on the mode as defined in [DOCSIS MULPIv4.0] in addition to Pre-Equalization on or off.

The CM transmits probes with the same target power as given above plus $\text{Probe}_{\text{delta_n-FDD}}$ when Pre-Equalization is enabled for probes in the P-MAP which provides the probe opportunity:

$$P_{t_sc_i} = P_{1.6r_n\text{-FDD}} + \text{Probe}_{\text{delta_n-FDD}} + \text{Pre-Eq}_i - 10\log_{10}(\text{number_of subcarriers in 1.6 MHz } \{32 \text{ or } 64\})$$

When the Pre-Equalization is disabled for the probe opportunity in the P-MAP, the FDD CM then transmits probe subcarrier with target power:

$$P_{t_sc_i} = P_{1.6r_n\text{-FDD}} + \text{Probe}_{\text{delta_n-FDD}} - 10\log_{10}(\text{number_of subcarriers in 1.6 MHz } \{32 \text{ or } 64\})$$

That is, the reported power for channel n, normalized to 1.6 MHz, less a factor taking into account the number of subcarriers in 1.6 MHz.

The total transmit power in channel n, P_{t_n} , in a frame is the sum of the individual transmit powers $P_{t_sc_i}$ of each subcarrier in channel n, where the sum is performed using absolute power quantities (non-dB domain).

The transmitted power level in channel n varies dynamically as the number and type of allocated subcarriers varies.

7.3.4.12.5.1 Terminology Used in Sections Covering FDD Upstream Transmit Power Requirements

This section provides a brief description of the terms used in elaboration of the transmit power requirements.

$BW_{\text{OFDMA-FDD}}$	The combined occupied bandwidth of the FDD OFDMA channel(s) in the FDD Band Transmit Channel Set (TCS_FDD).
DRW_FDD	The dynamic range window of a FDD channel.
$N_{\text{eq-FDD}}$	Number of Equivalent DOCSIS 1.6 MHz Upstream Channels in the cable modem's FDD Band Transmit Channel set (TCS_FDD). $N_{\text{eq}} = \text{ceil}(BW_{\text{OFDMA}} \text{ (MHz)}/1.6 \text{ MHz})$
$P_{1.6c_n\text{-FDD}}$	Commanded Power for FDD channel n. (TLV-17 in RNG-RSP)
$P_{1.6\text{load_i-FDD}}$	The transmit channel loading $P_{1.6\text{load_i-FDD}}$. This describes how close the transmit power level for a particular channel is to the top of the DRW_FDD. The highest loaded FDD channel $P_{1.6\text{load_1-FDD}}$ is the channel for which the reported power $P_{1.6r_n\text{-FDD}}$ is closest to the top of the DRW_FDD. In the case where there are j channels in the TCS_FDD, the lowest loaded channel $P_{1.6\text{load_j-FDD}}$ is the FDD channel whose reported power $P_{1.6r_n\text{-FDD}}$ is furthest from the top of the DRW_FDD.
$P_{1.6\text{load_min_set-FDD}}$	The number of dB below $P_{\text{ref-FDD}}$ which defines the top of the DRW_FDD. The top of the Dynamic Range Window of the OFDMA FDD spectrum can be reduced from $P_{\text{ref-FDD}}$ by adjusting $P_{\text{load_min_set-FDD}}$ to a value greater than 0 dB.
$P_{1.6\text{low-FDD}}$	Minimum transmit power to which a CM can be configured to transmit in the FDD Band. OFDMA channels in the FDD Band do not have boosted pilots so $P_{1.6\text{low-FDD}} = P_{1.6\text{Min-FDD}}$.

$P_{1.6low_multi-FDD}$	Bottom of DRW_FDD.
$P_{1.6low_n-FDD}$	The minimum equivalent channel power for a particular FDD channel that the CM is permitted to support.
$P_{1.6min-FDD}$	Minimum transmit power to which a CM can be configured to transmit in the FDD Band. OFDMA channels in the FDD Band do not have boosted pilots, so $P_{1.6low-FDD} = P_{1.6min-FDD}$. $P_{1.6min-FDD} = -15$ dB for the UHS-684 split and $P_{1.6min-FDD} = -18$ dB for the UHS-300, UHS-396, or UHS-492 split.
$P_{1.6r_n-FDD}$	The equivalent channel power of an FDD OFDMA channel "n". $P_{1.6r_n-FDD}$ is the average power at interface F' of the OFDMA subcarriers of the channel normalized to 1.6 MHz bandwidth and referenced to the Upstream Reference Power Spectral Density at interface F' when the channel is fully granted. $P_{1.6r_n-FDD}$ is the channel power reported in the RNG-REQ messages. This is also referred to in the specification as Reported Transmit Power.
$P_{limit-FDD}$	The maximum power per channel, increased from $P_{ref-FDD}$ for which fidelity requirements only degrade gradually, when $P_{1.6load_min_set-FDD} = 0$. Fidelity requirements do not apply for channel power commanded higher than $P_{limit-FDD}$. Fidelity requirements do not apply whenever TCP exceeds P_{maxFDD} .
P_{maxFDD}	The maximum total transmit power that the CM can support in the FDD Band depends on the supported FDD split option. The default value and the lowest allowable value for P_{maxFDD} is 58.6 dBmV for UHS-300, 61.3 dBmV for UHS-396, 63.6 dBmV for UHS-492, or 64.5 dBmV for UHS-684. Fidelity requirements do not apply if Total Channel Power exceeds P_{maxFDD} .
$P_{ref-FDD}$	The upstream reference power spectral density in the FDD Band. $P_{ref-FDD}$ is the power in dBmV in 1.6 MHz of subcarriers with no pre-equalization. For UHS-684, $P_{ref-FDD}$ at 108.8 MHz is 33.0 dBmV/1.6 MHz and $P_{ref-FDD}$ at 683.2 MHz is 43.0 dBmV/1.6 MHz for a slope of (10 dB/360 slots of 1.6 MHz in the FDD Band) dBmV/1.6 MHz, and a total variation of 10.0 dB across 108 MHz to 684 MHz. For UHS-300, UHS-396, and UHS-492, $P_{ref-FDD}$ at 108.8 MHz is 36.0 dBmV/1.6 MHz and $P_{ref-FDD}$ at 683.2 MHz is 46.0 dBmV/1.6 MHz for a slope of (10 dB/360 slots of 1.6 MHz in the FDD Band) dBmV/1.6 MHz and a total variation of 10.0 dB across 108 MHz to 684 MHz.
P_{t_n-FDD}	The total transmit power in a channel n in the FDD Band.
$P_{t_sc_i}$	The average target power transmitted by the i^{th} subcarrier for either probes or other transmissions, possibly with different power for the probe transmissions (see $Probe_{delta_n-FDD}$ below).
Pre-Eq _i	The magnitude of the i^{th} subcarrier pre-equalizer coefficient (dB).
$Probe_{delta_n-FDD}$	This term is used to account for reduction in Probe power resulting from the Power bit and Start Subc bits in the Probe Information Element in the P-MAP for the n^{th} FDD OFDMA channel.
TCS_FDD	An FDD CM's Transmit Channel Set in the FDD Band (108 MHz to 684 MHz).

7.3.4.12.6 Reconfiguration Time for FDD CMs

In an FDD DOCSIS system, there are two independent transmission channel sets: one for the legacy upstream channels (TCS), and one for the FDD upstream channels (TCS_FDD).

Section 7.2.4.12.4 of [DOCSIS PHYv3.1] applies to TCS only, while this section applies to TCS_FDD.

Reconfiguration time for FDD upstream channels is the inactive time interval provided between active upstream transmissions on a given FDD upstream channel when a change is commanded for a transmission parameter on that channel.

For changes in the Ranging Offset and/or Pre-Equalization of an FDD upstream channel, the FDD CM MUST be able to transmit consecutive bursts as long as the CMTS allocates the time duration (reconfiguration time) of at least one inactive frame in between the bursts on the FDD upstream channel with the changed parameter.

"Global reconfiguration time" in the FDD upstream channels is defined as the inactive time interval provided between active FDD upstream transmissions, which simultaneously satisfies the requirement in this section for all OFDMA channels in the TCS_FDD.

Global "quiet" across all active FDD upstream channels requires the intersection of ungranted burst intervals across all active OFDMA FDD channels to be at least 20 microseconds.

Even with a change or re-command of $P_{1.6load_min_set-FDD}$, the FDD CM MUST be able to transmit consecutive bursts as long as the FDD CMTS allocates at least one frame in between bursts, across all OFDMA channels in the TCS_FDD, where the quiet lapses in each channel contain an intersection of at least 20 microseconds. (From the end of a burst on one FDD upstream channel to the beginning of the next burst on any other FDD upstream channel, there is to be at least 20 microseconds duration to provide a "global reconfiguration time" for all channels in the CM's TCS_FDD.)

The FDD CMTS SHOULD provide global reconfiguration time to the TCS_FDD for the FDD CM before (or concurrently as) the CM has been commanded to change any upstream channel transmit power in the TCS_FDD by ± 3 dB cumulative since its last global reconfiguration time.

Global Reconfiguration Time for the legacy upstream channels (TCS) is completely disassociated with TCS_FDD grants or commands to the FDD CM, and Global Reconfiguration Time for the FDD upstream channels (TCS_FDD) is completely disassociated with the TCS grants or commands to the FDD CM.

7.3.4.12.7 Fidelity Requirements for FDD

The following requirements assume that any pre-equalization is disabled, unless otherwise noted. Signal power and measurements are all referenced to Interface F' of Figure 26.

When channels in the TCS_FDD are commanded to the same equivalent channel powers, the reference signal power in the "dBc" definition is to be interpreted as the measured average total transmitted power at Interface F'. When channels in the TCS_FDD are commanded to different equivalent channel powers, the commanded total power of the transmission is computed, and a difference is derived compared to the commanded total power which would occur if all channels had the same $P_{1.6\sigma, n-FDD}$ as the highest equivalent channel power in the TCS_FDD, whether or not the channel with the largest equivalent channel power is included in the grant. Then this difference is added to the measured total transmit power to form the reference signal power for the "dBc" spurious emissions requirements.

7.3.4.12.7.1 Spurious Emissions for FDD

The noise and spurious power generated by the FDD CM MUST NOT exceed the levels given in Table 33 - Spurious Emissions for FDD, Table 34 - FDD Spurious Emissions Requirements in the Upstream Frequency Range for Grants of Under-grant Hold Bandwidth and Larger, and Section 7.3.4.12.7.1.2, Adjacent Channel Spurious Emissions.

Up to five discrete spurs can be excluded from the emissions requirements listed in Table 33 and Table 34 for each of the spectral regions 85 MHz to 300 MHz, 300 MHz to 492 MHz, 492 MHz to 684 MHz, 684 MHz to 804 MHz, 804 MHz to 1218 MHz and 1218 MHz to 1794 MHz, while the FDD CM is Transmitting Burst upstream in the FDD band. The five excluded discrete spurs have to be no more than 2 dB in excess of the MER value of Table 36, with 100% grant, relative to a single subcarrier power level at the top of the DRW_FDD.

For example, with 12 dB uptilt at 108 MHz, the MER requirement from Table 36 is 36 dB, and so a discrete spur at 108 MHz, if one of the five to be excluded in the range of 85 MHz to 300 MHz, could reach as high as -34 dBc and still qualify for exclusion, where 0 dBc corresponds to the power in a subcarrier at the top of the DRW_FDD at 108 MHz. For the exclusions in the spectral regions 684 MHz to 804 MHz, 804 MHz to 1218 MHz and 1218 MHz to 1794 MHz, the exclusion limit corresponds to the value 2 dB relaxed from the MER requirement at 684 MHz, and the 0 dBc reference is the top of the DRW_FDD at 684 MHz. For the exclusions in the spectral region 85 MHz to 108 MHz, the exclusion limit corresponds to the value 2 dB relaxed from the MER requirement at 108 MHz, and the 0 dBc reference is the top of the DRW_FDD at 108 MHz. In each band (5 MHz to 85 MHz; 108 MHz to 300 MHz; 300 MHz to 492 MHz; 492 MHz to 684 MHz; 684 MHz to 804 MHz; 804 MHz to 1218 MHz and 1218 MHz to 1794 MHz) up to 3 discrete spurs up to -40 dBmV may be excluded from the Between Burst requirements, and also 3 such discrete spur exclusions up to -40 dBmV for the 5 MHz to 85 MHz Transmitting Burst requirement. Only a total of 15 different discrete spur exclusion frequencies are allowed in 5 MHz to 1218 MHz. The 15 different exclusion frequencies are allowed, with the limitation of five or three per band as described above, but these 15 exclusion frequencies are applied to all tests; a different set of ten exclusion frequencies is NOT allowed for different tests and different modes.

SpurFloor is defined as:

$$\text{SpurFloor} = -51.8 \text{ dBc}$$

Under-grant Hold Number of Users is defined as:

$$\text{Under-grant Hold Number of Users} = \text{Floor} \{ 0.2 + 10^{((-44 - \text{SpurFloor})/10)} \} = 6$$

Under-grant Hold Bandwidth (UGHB) is defined as:

$$\text{Under-grant Hold Bandwidth} = (\text{FDD Upstream Allocated Spectrum}) / (\text{Under-grant Hold Number of Users})$$

The spurious performance requirements defined above only apply when the CM is operating within certain ranges of values for $P_{1.6load_i-FDD}$, for $i = 1$ to the number of upstream channels in the TCS_FDD, and for granted bandwidth of Under-grant Hold Bandwidth or larger; where $P_{1.6load_1-FDD}$ is the highest loaded channel in this specification (i.e., its power is the one closest to $P_{ref-FDD}$).

When an FDD CM is transmitting over a bandwidth of less than Under-grant Hold Bandwidth the spurious emissions requirement limit is the power value (in dBmV per 1.6 MHz), corresponding to the specifications for the power level associated with a grant of bandwidth equal to Under-grant Hold Bandwidth.

The FDD CM MUST meet the spurious emissions performance requirements when the equivalent DOCSIS channel powers ($P_{1.6r_n-FDD}$) are within 0-6 dB below the top of the DRW_FDD ($P_{1.6load_min_set-FDD} + 6 \geq P_{1.6load_i-FDD} \geq P_{1.6load_min_set-FDD}$) but is not required to meet spurious emissions performance requirements when $P_{1.6r_n-FDD}$ are not within this range.

Further, the FDD CM MUST meet the spurious emissions performance requirements when $P_{1.6load_1-FDD} = P_{1.6load_min_set-FDD}$. When $P_{1.6load_1-FDD} > P_{1.6load_min_set-FDD}$, the spurious emissions requirements in absolute terms are relaxed by $P_{1.6load_1-FDD} - P_{1.6load_min_set-FDD}$ but is not required to meet spurious emissions performance requirements when this condition is not met.

The spurious performance requirements do not apply to any upstream channel from the time the output power on any active upstream channel has varied by more than ± 3 dB since the last global reconfiguration time through the end of the next global reconfiguration time changes.

In Table 33, in-band spurious emissions include noise, carrier leakage, clock lines, synthesizer spurious products, and other undesired transmitter products. It does not include ISI. The measurement bandwidth for in-band spurious emissions for OFDM is equal to the Subcarrier Clock Frequency (25 kHz or 50 kHz) and is not a synchronous measurement. The signal reference power for OFDMA in-band spurious emissions is the total transmit power measured and adjusted (if applicable) as described in Section 7.3.4.12.7, and then apportioned to a single data subcarrier.

The measurement bandwidth is 4 MHz for the Between Bursts (none of the channels in the TCS_FDD is bursting) specs of Table 33. The signal reference power for Between Bursts transmissions, "0 dBr", is the PSD for the top of the DRW_FDD, as measured at Interface F'.

The Transmitting Burst specs apply during the minislots granted to the FDD CM in the FDD Band (when the FDD CM uses all or a portion of the grant), and for 20 μ s before and after the granted minislot for OFDMA. The Between Bursts specs apply except during a used grant of minislots on any active channel in the FDD Band for the CM, and 20 μ s before and after the used grant for OFDMA. In Table 33 entries, the signal reference power, "0 dBr", is the PSD for the top of the DRW_FDD, as measured at Interface F'.

For the purpose of spurious emissions definitions, a granted burst refers to a burst of minislots to be transmitted at the same time from the same FDD CM; these minislots are not necessarily contiguous in frequency.

For Initial Ranging and before completion of Fine Ranging, spurious emissions requirements use Table 33 and Table 34, and if transmissions use subcarrier power which is X dB lower than indicated by $P_{1.6low-FDD}$, then the spurious emissions requirements in absolute terms are relaxed by X dB.

Spurious emissions requirements for grants of 10% or less of the FDD Upstream Allocated Spectrum may be relaxed by 2 dB in an amount of spectrum equal to:

measurement BW * ceil(10% of the FDD Upstream Allocated Spectrum / measurement BW)

anywhere in the whole upstream spectrum for emission requirements specified in Table 34.

A 2 dB relief applies in the measurement bandwidth. This relief does not apply to between bursts emission requirements.

The FDD CMTS MUST NOT command a grant to the FDD CM in the FDD Band which is smaller than the Minimum Grant Bandwidth shown in Table 34 - FDD Spurious Emissions Requirements in the Upstream Frequency Range for Grants of Under-grant Hold Bandwidth and Larger, which is 10.4 MHz with 192 MHz FDD Upstream Allocated Spectrum, 16.0 MHz with 288 MHz FDD Upstream Allocated Spectrum, 21.2 MHz with 384 MHz FDD Upstream Allocated Spectrum, and 32.0 MHz with 576 MHz FDD Upstream Allocated Spectrum.

Table 33 - Spurious Emissions for FDD CM

Parameter	Transmitting Burst ^{1,5,10,11,12,14,16}	Between Bursts ^{5,10,11,12,15,16}
Inband (Modulated spectrum of the grant)	-42 dBr OFDMA 100% grant ^{4,5,6,8,9} -47 dBr OFDMA UGHB% grant ^{4,5,6,8,9}	Max{-72 dBr, -43 dBmV}
Adjacent Minislot (adjacent to the modulated spectrum of the grant) 400 kHz next to modulated spectrum	+ 0.2 dB relaxation. See Table 34	Same as for Inband
FDD Band Within 108 MHz to [Upstream upper edge] (excluding assigned channel, adjacent channels).	See 7.3.4.12.7.1.2	Same as for Inband
Requirements for the emissions from 5 MHz to 108 MHz and 684 MHz and above CM Integrated Spurious Emissions Limits (all in 4 MHz, includes discretely) ¹		
5 MHz to 85 MHz	-45 dBmV	-50 dBmV
85 MHz to 108 MHz	-35 dBr	Same as Inband
Upstream/Downstream Transition [DS lower band edge] to 1794 MHz	-42 dBr -45 dBmV	Same as Inband -45 dBmV
CM Discrete Spurious Emissions Limits ¹	For all four bands:	5 MHz to 85 MHz
5 MHz to 85 MHz	Largest Discrete Spurious Emissions at least 5 dB lower power than the limit on Integrated Spurious Emissions in 4 MHz, in the same band (see table row above)	Largest Discrete Spurious Emissions at least 3 dB lower power than the limit on Integrated Spurious Emissions in 4 MHz, in the same band (see table row above)
85 MHz to 108 MHz		
Upstream/Downstream Transition band [DS lower band edge] to 1794 MHz		85 MHz to 108 MHz Upstream/Downstream Transition band [DS lower band edge to 1794 MHz] Largest Discrete Spurious Emissions at least 5 dB lower power than the limit on Integrated Spurious Emissions in 4 MHz, in the same band (see table row above)

Parameter	Transmitting Burst ^{1,5,10,11,12,14,16}	Between Bursts ^{5,10,11,12,15,16}
Table Notes:		
Note 1. Up to 5 discrete spurs in each of the following bands may be excluded: 85 MHz to 300 MHz; 300 MHz to 492 MHz; 492 MHz to 684 MHz; 684 MHz to 804 MHz; and 804 MHz to 1218 MHz, 1218 MHz to 1794 MHz while the CM is Transmitting Burst in the FDD band. These 5 spurs are the same spurs that may be excluded for spurious emissions and MER and not an additional or different set.		
Note 2. N/A.		
Note 3. N/A.		
Note 4. N/A.		
Note 5. This value is to be met when $P_{1,6load} = P_{1,6load_min_set}$. "0 dBr" is referenced to the top of the DRW_FDD.		
Note 6. Receive equalization is allowed if an MER test approach is used, to take ISI out of the measurement; measurements other than MER-based to find spurs or other unwanted power may be applied to this requirement.		
Note 7. N/A		
Note 8. Frequency-Dependent Relaxation as a function of the measurement center frequency, linearly scales in frequency from 5 dB at 108 MHz to 0 dB at 684 MHz.		
Note 9. 1 dB relaxation with 12 dB up tilt.		
Note 10. "dBr" values measured at Interface F', "dBmV" values measured at Interface F, and all measurements and averages computed over 4 MHz bandwidth unless noted otherwise.		
Note 11. Transmitting Burst is with FDD Band upstream bursting, and Between Burst is with FDD Band upstream between bursts entirely in 108 MHz to 684 MHz.		
Note 12. For all the requirements except for the 5 MHz to 85 MHz and 85 MHz to 108 MHz, both Transmitting Burst and Between Burst, the requirements need to be met with the legacy upstream (5 MHz to 85 MHz) bursting. With the requirements in 5 MHz to 85 MHz and 85 MHz to 108 MHz, the requirements need to be met with the legacy upstream (5 MHz to 85 MHz) between bursts.		
Note 13. N/A.		
Note 14. Allowance for 3 excluded discrete spurs up to -40 dBmV in the 5 MHz to 85 MHz while Transmitting Burst.		
Note 15. Allowance for 3 excluded discrete spurs in each of the bands (5 MHz to 85 MHz; 85 MHz to 300 MHz; 300 MHz to 492 MHz; 492 MHz to 684 MHz; 684 MHz to 804MHz, 804 MHz to 1218 MHz and 1218 MHz to 1794 MHz) up to -40 dBmV while Between Bursts.		
Note 16. For the discrete spur exclusions of Note 1, Note 14, and Note 15, a total of 15 different such exclusion frequencies are allowed to be applied for all the requirements, across the full 5 MHz to 1794 MHz range, while also accommodating the restrictions on the number of exclusions in any one band. The 15 exclusion frequencies are not allowed to change for application to different requirements, nor due to changes in mode in the CM under test.		

7.3.4.12.7.1.1 Spurious Emissions in the Upstream FDD Frequency Range

Table 34 lists the required spurious level in a measurement interval. The initial measurement interval at which to start measuring the spurious emissions (from the transmitted burst's modulation edge) is 400 kHz from the edge of the transmission's modulation spectrum. Measurements should start at the initial distance and be repeated at increasing distance from the carrier, until the upstream band edge or spectrum adjacent to another modulated spectrum is reached.

In addition to the spurious emissions level generated in Table 35, there is a frequency-dependent relaxation provided as a function of the center frequency of the measurement, which is given in Table Note 3 of Table 35 as:

$$\text{Frequency-Dependent_Spurious_Emissions_Relaxation} = 5 * (684 \text{ MHz} - \text{measurement_center_frequency}) / (684 \text{ MHz} - 108 \text{ MHz}) \text{ dB.}$$

For example, with 576 MHz FDD Upstream Allocated Spectrum and 96 MHz grant, the requirement is -61.8 dBc at 679.2 MHz and -56.8 dBc at 112.8 MHz.

For OFDMA transmissions with non-zero transmit windowing, the FDD CM MUST meet the required performance measured within the 2.0 MHz adjacent to the modulated spectrum using slicer values from an FDD CMTS burst receiver or equivalent, synchronized to the downstream transmission provided to the FDD CM.

In the rest of the spectrum, the FDD CM MUST meet the required performance measured with a bandpass filter (e.g., an unsynchronized measurement).

For OFDMA transmissions with zero transmit windowing, the FDD CM MUST meet the required performance using synchronized measurements across the complete upstream spectrum.

Spurious emissions allocation for far out spurious emissions =

$$\text{Round} \{ \text{SpurFloor} + 10 * \log_{10}(\text{Measurement bandwidth} / \text{Under-grant hold Bandwidth}), 0.1 \}.$$

For transmission bursts with modulation spectrum less than the Under-grant Hold Bandwidth, the spurious power requirement is calculated as above, but increased by $10 * \log_{10}(\text{Under-grant Hold Bandwidth} / \text{Grant Bandwidth})$.

Table 34 - FDD Spurious Emissions Requirements in the Upstream Frequency Range for Grants of Under-grant Hold Bandwidth and Larger

FDD Upstream Allocated Spectrum (MHz)	Minimum Grant Bandwidth (MHz)	SpurFloor (dBc)	Under-grant Hold #Users	Under-grant Hold Bandwidth (MHz)	Measurement Bandwidth (MHz) ¹	Specification in the Interval (dBc) ^{2,3}
192	10.4	- 51.8	6	32	9.6	-57.0
288	16.0	- 51.8	6	48	9.6	-58.8
384	21.2	- 51.8	6	64	9.6	-60.0
576	32.0	- 51.8	6	96	9.6	-61.8

Table Notes:

Note 1. The measurement bandwidth is a contiguous sliding measurement window.

Note 2. Frequency-Dependent Relaxation as a function of the measurement center frequency, linearly scales in frequency from 5 dB at 108 MHz to 0 dB at 684 MHz.

Note 3. 1 dB relaxation with 12 dB up tilt

The FDD CM MUST control transmissions such that within the measurement bandwidth of Table 34 - FDD Spurious Emissions Requirements in the Upstream Frequency Range for Grants of Under-grant Hold Bandwidth and Larger, spurious emissions measured for individual subcarriers contain no more than +3 dB power larger than the required average power of the spurious emissions in the full measurement bandwidth divided by the number of subcarriers in the measurement bandwidth. When non-synchronous measurements are made, only 25 kHz measurement bandwidth is used.

For OFDMA transmissions, bandpass measurements rather than synchronous measurements may be applied.

7.3.4.12.7.1.2 Adjacent Channel Spurious Emissions

Spurious emissions from a transmitted burst may occur in adjacent spectrum, which could be occupied by OFDMA subcarriers transmitted by another CM.

The spurious emissions requirements for adjacent spectrum to a transmitted burst are given in Table 34 but with an additional 0.2 dB allowance, where the measurement is over the 9.6 MHz spectrum adjacent to the modulated spectrum.

The measurement is performed starting on an adjacent subcarrier of the transmitted spectrum (both above and below), using the slicer values from a FDD CMTS burst receiver or equivalent synchronized to the downstream transmission provided to the FDD CM.

The FDD CM MUST control transmissions such that within the adjacent 400 kHz of modulated spectrum, spurious emissions measured for individual subcarriers contain no more than +5 dB power larger than the required average power of the spurious emissions in the full measurement bandwidth divided by the number of subcarriers in the measurement bandwidth.

For the 9.2 MHz measurement bandwidth which is outside the 400 kHz adjacent to the modulated spectrum, the FDD CM MUST control transmissions such that spurious emissions measured for individual subcarriers contain no more than +3 dB power larger than the required average power of the spurious emissions in the full measurement bandwidth divided by the number of subcarriers in the measurement bandwidth. For any portion of the 9.6 MHz measurement bandwidth where non-synchronous measurements are made, only 25 kHz measurement bandwidth is used.

Bandpass measurements rather than synchronous measurements may be applied where possible.

7.3.4.12.7.1.3 Spurious Emissions During FDD Burst On/Off Transients

The FDD CM MUST control spurious emissions prior to and during ramp-up, during and following ramp-down, and before and after a burst.

The FDD CM's on/off spurious emissions, such as the change in voltage at the upstream transmitter output, due to enabling or disabling transmission, MUST be no more than 50 mV.

The FDD CM's voltage step MUST be dissipated no faster than 4 μ s of constant slewing. This requirement applies when the FDD CM is transmitting at +55 dBmV or more per channel on any channel.

At backed-off transmit levels, the FDD CM's maximum change in voltage MUST decrease by a factor of 2 for each 6 dB decrease of power level in the highest power active channel, from +55 dBmV per channel, down to a maximum change of 3.5 mV at 31 dBmV per channel and below; this requirement does not apply to FDD CM power-on and power-off transients.

7.3.4.12.7.2 FDD OFDMA MER Requirements

Transmit modulation error ratio (TxMER or just MER) measures the cluster variance caused by the FDD CM during upstream transmission due to transmitter imperfections. The terms "equalized MER" and "unequalized MER" refer to a measurement with linear distortions equalized or not equalized, respectively, by the test equipment receive equalizer. The requirements in this section refer only to unequalized MER, as described for each requirement. MER is measured on each modulated data subcarrier and non-boosted pilot (MER is computed based on the unboosted pilot power) in a minislot of a granted burst and averaged for all the subcarriers in each minislot. MER includes the effects of Inter-Carrier Interference (ICI), spurious emissions, phase noise, noise, distortion, and all other undesired transmitter degradations with an exception for a select number of discrete spurs impacting a select number of subcarriers. MER requirements are measured with a calibrated test instrument that synchronizes to the OFDMA signal, applies a receive equalizer in the test instrument that removes MER contributions from nominal channel imperfections related to the measurement equipment, and calculates the value. The equalizer in the test instrument is calculated, applied and frozen for the FDD CM testing. Receiver equalization of FDD CM linear distortion is not provided; hence, this is considered to be a measurement of unequalized MER, even though the test equipment contains a fixed equalizer setting.

7.3.4.12.7.2.1 Definitions

MER is defined as follows for OFDMA. The transmitted RF waveform at the F connector of the FDD CM (after appropriate down conversion) is filtered, converted to baseband, sampled, and processed using standard OFDMA receiver methods, with the exception that receiver equalization is not provided. The processed values are used in the following formula. No external noise (AWGN) is added to the signal.

The carrier frequency offset, carrier amplitude, carrier phase offset, and timing will be adjusted during each burst to maximize MER as follows:

- One carrier amplitude adjustment common for all subcarriers and OFDM symbols in burst.
- One carrier frequency offset common for all subcarriers resulting in phase offset ramping across OFDM symbols in bursts.
- One timing adjustment resulting in phase ramp across subcarriers.
- One carrier phase offset common to all subcarriers per OFDM symbol in addition to the phase ramp.

MER_i is computed as an average of all the subcarriers in a minislot for the ith minislot in the OFDMA grant:

$$\text{MER}_i \text{ (dB)} = 10 \cdot \log_{10} \left(\frac{E_{avg}}{\frac{1}{N} \sum_{j=1}^N \left(\frac{1}{M} \sum_{k=1}^M |e_{j,k}|^2 \right)} \right)$$

where:

E_{avg} is the average constellation energy for equally likely symbols,

M is the number of symbols averaged,

N is the number of subcarriers in a minislot,

$e_{j,k}$ is the error vector from the j^{th} subcarrier in the minislot and k^{th} received symbol to the ideal transmitted QAM symbol of the appropriate modulation order.

A sufficient number of OFDMA symbols are to be included in the time average so that the measurement uncertainty from the number of symbols is less than other limitations of the test equipment.

MER with a 100% grant is defined as the condition when all OFDMA non-excluded subcarriers in the transmit channel set are granted to the FDD CM. For purposes of testing MER, a grant of all OFDMA minislots in the transmit channel set may be used; there may be non-excluded subcarriers that are not within minislots.

MER with a UGHB is defined as the condition when less than or equal to UGHB of the FDD OFDMA minislots have been granted to the FDD CM.

7.3.4.12.7.2.2 FDD Requirements

Unless otherwise stated, the FDD CM MUST meet or exceed the following MER limits over the full transmit power range, all modulation orders, all grant configurations and over the full upstream frequency range.

The following flat channel measurements (ideally flat channel except for downtilt specified between Interface F and F') with the transmitted specified uptilt (Table 35) are made after the pre-equalizer coefficients have been set to their optimum values. The receiver uses best effort synchronization to optimize the MER measurement.

Table 35 - Upstream MER Requirements (with Pre-Equalization)

Parameter	Value
MER (100% grant)	Each minislot MER \geq 42 dB (Notes 1, 2, 3, 4, 5) at 684 MHz with 8 dB and 10 dB uptilt
MER (UGHB % grant)	Each minislot MER \geq 47 dB (Notes 1, 2, 3, 4) at 684 MHz with 8 dB and 10 dB uptilt
Pre-equalizer constraints	Coefficients set to their optimum values
Table Notes:	
Note 1. Up to 5 subcarriers within the entire upstream bandwidth with discrete spurs may be excluded from the MER calculation if they fall within transmitted minislots. These 5 spurs are the same spurs that may be excluded for spurious emissions and not an additional or different set.	
Note 2. This value is to be met when $P_{1,6load} = P_{1,6load_min_set}$.	
Note 3. Frequency-Dependent Relaxation as a function of the measurement center frequency, linearly scales in frequency from 5 dB at 108 MHz to 0 dB at 684 MHz.	
Note 4. 1 dB relaxation with 12 dB uptilt	
Note 5. For testing 100% grant, a grant of all OFDMA minislots may be used.	

The following flat channel measurements (Table 36) are made with the pre-equalizer coefficients set to unity and with the transmitted specified uptilt and the receiver implementing best effort synchronization. For this measurement, the receiver may also apply partial equalization. The partial equalizer is not to correct for the portion of the FDD CM's time-domain impulse response greater than 200 ns or frequency-domain amplitude response greater than +1 dB or less than -3 dB from the average amplitude. An additional 1 dB attenuation in the amplitude response is allowed in the upper 10% of the specified passband frequency. It is not expected that the partial equalizer is implemented on the FDD CMTS receiver. A partial equalizer could be implemented offline via commercial receivers or simulation tools.

Table 36 - Upstream MER Requirements (no Pre-Equalization)

Parameter	Value
MER (100% grant)	Each minislot MER \geq 39 dB (Notes 1, 2, 3, 4) at 684 MHz with 8 dB and 10 dB uptilt
MER (UGHB% grant)	Each minislot MER \geq 39 dB (Notes 1, 2, 3, 4) at 684 MHz with 8 dB and 10 dB uptilt
Pre-equalizer constraints	Pre-equalization not used

Parameter	Value
Table Notes:	
Note 1. Up to 5 subcarriers within the entire upstream bandwidth with discrete spurs may be excluded from the MER calculation if they fall within transmitted minislots. These 5 spurs are the same spurs that may be excluded for spurious emissions and not an additional or different set.	
Note 2. This value is to be met when $P_{1,load} = P_{1,load_min_set}$.	
Note 3. Frequency-Dependent Relaxation as a function of the measurement center frequency, linearly scales in frequency from 5 dB at 108 MHz to 0 dB at 684 MHz.	
Note 4. 1 dB relaxation with 12 dB uptoilt	

7.3.4.13 Cable Modem Transmitter Output Requirements

The FDD CM MUST output an RF Modulated signal with characteristics delineated in Table 37 - FDD CM Transmitter Output Signal Characteristics.

Table 37 - FDD CM Transmitter Output Signal Characteristics

Parameter	Value																								
Frequency	Support and be configurable to a permitted subset (see Section 7.3.2.3 for allowed combinations) of the following list of frequency ranges: 5 MHz to 204 MHz 5 MHz to 85 MHz and 108 MHz to 300 MHz 5 MHz to 85 MHz and 108 MHz to 396 MHz 5 MHz to 85 MHz and 108 MHz to 492 MHz 5 MHz to 85 MHz and 108 MHz to 684 MHz NOT to cause harmful interference above these frequencies for any configured option.																								
Signal Type	OFDMA																								
Maximum OFDMA Channel Bandwidth	95 MHz																								
Minimum OFDMA Occupied Bandwidth	6.4 MHz for 25 kHz subcarrier spacing 10 MHz for 50 kHz subcarrier spacing																								
Number of Independently configurable OFDMA channels	Minimum of 7																								
Subcarrier Channel Spacing	25 kHz, 50 kHz																								
FFT Size	50 kHz: 2048 (2K FFT); 1900 Maximum active subcarriers 25 kHz: 4096 (4K FFT); 3800 Maximum active subcarriers																								
Sampling Rate	102.4 MHz																								
FFT Time Duration	40 μ s (25 kHz subcarriers) 20 μ s (50 kHz subcarriers)																								
Modulation Type	BPSK, QPSK, 8-QAM, 16-QAM, 32-QAM, 64-QAM, 128-QAM, 256-QAM, 512-QAM, 1024-QAM, 2048-QAM, 4096-QAM																								
Bit Loading	Variable from minislot to minislot Constant for subcarriers of the same type in the minislot Support zero valued subcarriers per profile and minislot																								
Pilot Tones	14 data patterns and 2 subslot patterns, minislot subcarrier size and length dependent - see Section 7.3.4.16.																								
Cyclic Prefix Options	<table> <thead> <tr> <th>Samples</th> <th>μs</th> </tr> </thead> <tbody> <tr><td>96</td><td>0.9375</td></tr> <tr><td>128</td><td>1.25</td></tr> <tr><td>160</td><td>1.5625</td></tr> <tr><td>192</td><td>1.875</td></tr> <tr><td>224</td><td>2.1875</td></tr> <tr><td>256</td><td>2.5</td></tr> <tr><td>288</td><td>2.8125</td></tr> <tr><td>320</td><td>3.125</td></tr> <tr><td>384</td><td>3.75</td></tr> <tr><td>512</td><td>5.0</td></tr> <tr><td>640</td><td>6.25</td></tr> </tbody> </table>	Samples	μ s	96	0.9375	128	1.25	160	1.5625	192	1.875	224	2.1875	256	2.5	288	2.8125	320	3.125	384	3.75	512	5.0	640	6.25
Samples	μ s																								
96	0.9375																								
128	1.25																								
160	1.5625																								
192	1.875																								
224	2.1875																								
256	2.5																								
288	2.8125																								
320	3.125																								
384	3.75																								
512	5.0																								
640	6.25																								

Parameter	Value
Windowing Size Options	Samples μ s 0 0 32 0.3125 64 0.625 96 0.9375 128 1.25 160 1.5625 192 1.875 224 2.1875 Raised cosine absorbed by CP
Level	Total average output power of 65 dBmV or greater
Output Impedance	75 ohms
Output Return Loss	> 6 dB in the selected frequency range in row 1
Connector	F connector per [ISO/IEC-61169-24] or [SCTE 02]

7.3.4.14 FDD RMD/RPD Receiver Capabilities

7.3.4.14.1.1 FDD RMD/RPD Receiver Input Power Requirements at Interface C

The FDD RMD/RPD MUST be settable according to Table 38 - FDD RMD/RPD Upstream Channel Demodulator Input Power Characteristics for intended received power normalized to 6.4 MHz of bandwidth. To clarify, an FDD RMD/RPD that implements a range of settable (chosen) set points (per US RF port) across a portion of the range in Table 38 complies with this requirement, and so is an FDD RMD/RPD that implements just a single fixed set point in this range.

The FDD RMD/RPD upstream demodulator MUST operate within its defined performance specifications at any set point it supports, with received bursts within the ranges defined in Table 38 - FDD RMD/RPD Upstream Channel Demodulator Input Power Characteristics of the set power.

Table 38 - FDD RMD/RPD Upstream Channel Demodulator Input Power Characteristics

Modulation	Minimum Set Point (dBmV/6.4 MHz)	Maximum Set Point (dBmV/6.4 MHz)	Range
QPSK	-4	25	-9 / +3
8-QAM	-4	25	-9 / +3
16-QAM	-4	25	-9 / +3
32-QAM	-4	25	-9 / +3
64-QAM	-4	25	-9 / +3
128-QAM	0	25	-9 / +3
256-QAM	0	25	-9 / +3
512-QAM	0	25	-3 / +3
1024-QAM	0	25	-3 / +3
2048-QAM	7	25	-3 / +3
4096-QAM	10	25	-3 / +3

BaseTargetRxPower TLV (98.3) in annex B of [R-PHY] is the reference power spectral density for all the upstream channels, in units of "dBmV/1.6 MHz"; note that this corresponds to the set point in this section, except that the latter has units of "dBmV/6.4 MHz." Each channel has its own TargetRxPowerAdjust TLV in annex B of [R-PHY], moving the target power spectral density for the indicated channel up or down from the set point (i.e., moved from the reference). However, the performance requirement admits no such adjustments (all channels are at the reference power spectral density, i.e., "the chosen set point"). This is the intention of the requirements and how they will be tested.

The FDD RMD/RPD MUST operate in the following conditions:

- The average upstream input total composite power, including ingress and noise, is up to 3 dB higher than the calculated total composite power based upon the chosen set point, as measured at interface C.
- and
- The average upstream input power, including ingress and noise, in any 6.4 MHz contiguous spectral region within the upstream frequency band is up to 8 dB higher than the set point, as measured at interface C.

7.3.4.14.2 FDD RMD/RPD Receiver Error Ratio Performance in AWGN Channel at Interface C

The required level for FDD RMD/RPD upstream post-FEC error ratio is defined for AWGN as less than or equal to 10^{-6} PER (packet error ratio) with 1500-byte Ethernet packets. This section describes the conditions at which the FDD RMD/RPD is required to meet this error ratio.

Implementation loss of the FDD RMD/RPD receiver MUST be such that the FDD RMD/RPD achieves the required error ratio when operating at a CNR as shown in Table 39 - FDD RMD/RPD Minimum CNR Performance in AWGN Channel, under input load and channel conditions as follows:

- A single transmitter, pre-equalized and ranged.
- An OFDMA channel with 95 MHz modulated spectrum (test channel).
- Ranging with same CNR and input level to FDD RMD/RPD measured at Interface C as with data bursts, and with 8-symbol probes.
- Input power level per constellation is at 0 dB offset from the minimum set point supported by the RMD/RPD, or the minimum set point defined in Table 38 - FDD RMD/RPD Upstream Channel Demodulator Input Power Characteristics, whichever is greater.
- Any remaining upstream spectrum is filled with DOCSIS 3.1 channels and/or DOCSIS 3.0 channels and/or R-OOB channels with the same PSD (except for minimal guard bands as required by the specifications).
- OFDMA phase noise and frequency offset are at the max limits as defined for the CM transmission specification.
- Ideal AWGN channel with no other artifacts (reflections, burst noise, tilt, etc.).
- Large grants consisting of several 1500 Bytes.
- The FDD CMTS is allowed to construct MAPs according to its own scheduler implementation.

Table 39 - FDD RMD/RPD Minimum CNR Performance in AWGN Channel

Constellation	CNR ^{1,2,3} (dB)	Set Point ⁴ (dBmV/6.4 MHz)	Offset
QPSK	11.0	-4	0 dB
8-QAM	14.0	-4	0 dB
16-QAM	17.0	-4	0 dB
32-QAM	20.0	-4	0 dB
64-QAM	23.0	-4	0 dB
128-QAM	26.0	0	0 dB
256-QAM	29.0	0	0 dB
512-QAM	32.5	0	0 dB
1024-QAM	35.5	0	0 dB
2048-QAM	39.0	7	0 dB
4096-QAM	43.0	10	0 dB

Constellation	CNR ^{1,2,3} (dB)	Set Point ⁴ (dBmV/6.4 MHz)	Offset
Table Notes: Note 1. CNR is defined here as the ratio of average signal power in occupied bandwidth to the average noise power in the occupied bandwidth given by the noise power spectral density integrated over the same occupied bandwidth. Note 2. Channel CNR is adjusted to the required level by measuring the source inband noise including phase noise component and adding the required delta noise from an external AWGN generator. Note 3. The channel CNR requirements are for OFDMA channels with non-boosted pilots. For operation with boosted pilots, which is optional at the FDD Node, the CNR requirements are increased by a) 1 dB for channels with 50 kHz subcarrier spacing, and b) 0.5 dB for channels with 25 kHz subcarrier spacing. For example, the CNR requirement for QPSK with boosted pilots is 12.0 dB with 50 kHz subcarrier spacing and 11.5 dB with 25 kHz subcarrier spacing. Note 4. The set point is as listed in this table, if supported by the RMD/RPD. Otherwise, it is the minimum set point supported by the RMD/RPD.			

7.3.4.15 Ranging

See [DOCSIS PHYv3.1], section 7.4.15.

7.3.4.16 Upstream Pilot Structure

See [DOCSIS PHYv3.1], section 7.4.16.

7.3.4.17 Upstream Pre-Equalization

See [DOCSIS PHYv3.1], section 7.4.17.

7.3.5 FDD Downstream Transmit and Receive

7.3.5.1 Overview

This section specifies the downstream electrical and signal processing requirements for the transmission of OFDM modulated RF signals from the FDD Node to the FDD CM.

7.3.5.2 Signal Processing

See [DOCSIS PHYv3.1], section 7.5.2.

7.3.5.3 Time and Frequency Synchronization

See [DOCSIS PHYv3.1], section 7.5.3.

7.3.5.4 Downstream Forward Error Correction

See [DOCSIS PHYv3.1], section 7.5.4.

7.3.5.5 Mapping Bits to QAM Constellations

See [DOCSIS PHYv3.1], section 7.5.5.

7.3.5.6 Interleaving and De-interleaving

See [DOCSIS PHYv3.1], section 7.5.6.

7.3.5.7 IDFT

See [DOCSIS PHYv3.1], section 7.5.7.

7.3.5.8 Cyclic Prefix and Windowing

See [DOCSIS PHYv3.1], section 7.5.8.

7.3.5.9 Downstream Fidelity Requirements

For the purposes of this specification, the number of occupied CTA channels of an OFDM channel is the occupied bandwidth of the OFDM channel divided by 6 MHz.

FDD RMD/RPDs capable of generating N -channels of legacy DOCSIS plus N_{OFDM} -channels of OFDM per RF port, for purposes of the DRFI output electrical requirements, the device is said to be capable of generating N_{eq} -channels per RF port, where $N_{\text{eq}} = N + 32 * N_{\text{OFDM}}$ "equivalent legacy DOCSIS channels."

An N_{eq} -channel per RF port FDD RMD/RPD MUST comply with all requirements operating with all N_{eq} channels on the RF port.

An N_{eq}' -channel per RF port device operating with N_{eq}' active channels on the RF port for all values of N_{eq}' less than N_{eq} .

For an OFDM channel there is a) the occupied bandwidth, b) the encompassed spectrum, c) the modulated spectrum, and d) the number of equivalent legacy DOCSIS channels.

The encompassed spectrum in MHz is 204.8 MHz minus the number of subcarriers in the Band edge Exclusion Sub-band for the upper and lower band edges (combined) times the subcarrier spacing in MHz. For example, with subcarrier spacing of 50 kHz and 150 lower band edge subcarriers and 152 upper band edge subcarriers for a total of 302 subcarriers in the two Band edge Exclusion Sub-bands, the encompassed spectrum = $204.8 - 302 * (0.05) = 189.7$ MHz. The encompassed spectrum is also equal to the center frequency of the highest frequency modulated subcarrier minus the center frequency of the lowest frequency modulated subcarrier in an OFDM channel, plus the subcarrier spacing.

The modulated spectrum of an OFDM channel is the encompassed spectrum minus the total spectrum in the Internal Excluded Sub-bands of the channel, where the total spectrum in the Internal Excluded Sub-bands is equal to the number of subcarriers in all of the Internal Excluded Sub-bands of the OFDM channel multiplied by the subcarrier spacing of the OFDM channel. In the previous example, if there are 188 subcarriers total in three Internal Exclusion Sub-bands, then the total spectrum in the Internal Excluded Sub-bands (in MHz) is $188 * 0.05 = 9.4$ MHz, and the modulated spectrum is $189.7 \text{ MHz} - 9.4 \text{ MHz} = 180.3 \text{ MHz}$.

The occupied bandwidth is a multiple of 6 MHz, with a minimum of 24 MHz, and consists of all CTA channels which include the modulated spectrum plus taper region shaped by the OFDM channels' transmit windowing; the out-of-band spurious emissions requirements apply outside the occupied bandwidth. With a 1 MHz taper region on each band edge of the OFDM channel, shaped by the transmit windowing function, encompassed spectrum of 189.7 MHz may provide 192 MHz of occupied bandwidth.

The number of equivalent active legacy DOCSIS channels in the OFDM channel N_{eq}' is the ceiling function applied to the modulated spectrum divided by 6 MHz. For the example, the number of equivalent legacy DOCSIS channels in the OFDM channel is $\text{ceiling}(180.3 \text{ MHz} / 6 \text{ MHz}) = 31$.

For an N_{eq} -channel per RF port device, the applicable maximum power per channel and spurious emissions requirements are defined using a value of $N^* = \text{minimum}(4N_{\text{eq}}', \text{ceiling}[N_{\text{eq}}'/4])$ for $N_{\text{eq}}' < N_{\text{eq}}/4$, and $N^* = N_{\text{eq}}$ otherwise.

These specifications assume that the FDD RMD/RPD entity will be terminated with a 75 Ohm load.

For the purpose of defining the downstream fidelity requirements in the next several sections, please refer to Figure 24; normative statements in this section apply to Interface C.

Figure 27 shows a reference waveform for the output of interface C.

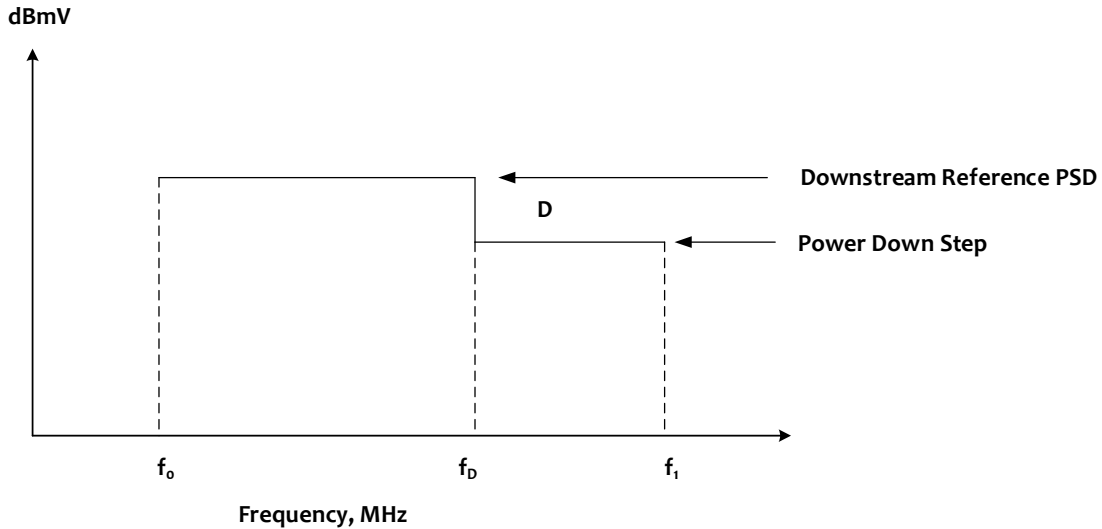

Figure 27 - Downstream Power RPD Step Down with D dB at F(D) MHz

7.3.5.9.1 RMD/RPD Output Electrical Requirements

For OFDM, all modulated subcarriers in an OFDM channel are set to the same average power (except pilots which are boosted by 6 dB). For purposes of spurious emissions requirements, the "commanded transmit power per channel" for an equivalent legacy DOCSIS channel is computed as follows:

- FDD RMP/RPD power is configured by power per CEA channel and number of occupied CEA channels for each OFDM channel.
- For each OFDM channel, the total power is Power per CEA channel + $10_{\log_{10}}$ (Number of occupied CEA channels) for that OFDM channel.
- The FDD RMD/RPD calculates power for data subcarrier and pilots (using total number of non-zero valued (non-excluded) subcarriers).
- The FDD RMD/RPD calculates power in 6 MHz containing PLC.
- For the spurious emissions requirements, power calculated for the 6 MHz containing the PLC is the commanded average power of an equivalent DOCSIS legacy channel for that OFDM channel.

An FDD RMD/RPD MUST output an OFDM RF modulated signal with the characteristics defined in Table 40 - FDD RMD/RPD RF Output Electrical Requirements, Table 41 - FDD RMD/RPD Output Power, and Table 42 - FDD RMD/RPD Output Out-of-Band Noise and Spurious Emissions Requirements. Legacy DOCSIS RF modulated signal characteristics are provided in Section 6.2.22.

The condition for these requirements is all N_{eq} ' combined channels, legacy DOCSIS channels and equivalent legacy DOCSIS channels, commanded to the same average power, except for the Single Channel Active Phase Noise, Diagnostic Carrier Suppression, OFDM Phase Noise, OFDM Diagnostic Suppression, and power difference requirements, and except as described for Out-of-Band Noise and Spurious Requirements.

Table 40 - FDD RMD/RPD RF Output Electrical Requirements

Parameter	Value
Downstream Lower Band Edge of an FDD RMD/RPD	DOCSIS 4.0 FDD Mode: 258 MHz Legacy Transition Mode: 54 MHz (See Notes 3, 12, and 13 following this table.)
Downstream Upper Band Edge of an FDD RMD/RPD	1794 MHz. (See Notes 3 and 12 following this table.)
Level	Adjustable. See Table 41.
Modulation Type	See Section 7.3.2.4.

Parameter	Value
OFDM channels' subcarrier spacing	25 kHz and 50 kHz
Inband Spurious, Distortion, and Noise 576 MHz total occupied bandwidth, 6 MHz gap (Internal Excluded subcarriers) 88 equivalent legacy DOCSIS channels. See Notes 4, 6	
For measurements below 600 MHz	≤ -50 dB Average over center 400 kHz subcarriers within gap
For measurements from 600 MHz to 1002 MHz	≤ -47 dB Average over center 400 kHz subcarriers within gap
For measurements 1002 MHz to 1794 MHz	≤ -45 dB Average over center 400 kHz subcarriers within gap
MER in any 192 MHz OFDM channel total occupied bandwidth See Notes 2, 4, 5, 6	≥ 48 dB Average over the complete OFDM channel. See Note 1
For measurements from 258 MHz to 1794 MHz	1.0 dB MER relaxation per 1.0 dB step-down value
MER in 24 MHz OFDM channel occupied bandwidth, single OFDM channel only, 24 MHz total occupied bandwidth: See Notes 1, 2, 4, 8	≥ 48 dB Average over the complete OFDM channel See Note 1.
For measurements from 258 MHz to 1794 MHz	
Phase noise, double sided maximum, Full power CW signal 1002 MHz or lower	1 kHz to 10 kHz: -48 dBc 10 kHz to 100 kHz: -56 dBc 100 kHz to 1 MHz: -60 dBc 1 MHz to 10 MHz: -54 dBc 10 MHz to 100 MHz: -58 dBc (Note 9)
Full power 192 MHz OFDM channel block with 6 MHz in center as Internal Exclusion sub-band + 0 dBc CW in center, with block not extending beyond 1002 MHz (CW not processed via FFT)	1 kHz to 10 kHz: -48 dBc 10 kHz to 100 kHz: -56 dBc
Full power 192 MHz OFDM channel block with 24 MHz in center as Internal Exclusion sub-band + 6 dBc CW in center, with block not extending beyond 1002 MHz (CW not processed via FFT)	100 kHz to 1 MHz: -59 dBc
Full power 192 MHz OFDM channel block with 30 MHz in center as Internal Exclusion sub-band + 7 dBc CW in center, with block not extending beyond 1002 MHz (CW not processed via FFT)	1 MHz to 10 MHz: -53 dBc
Output Impedance	75 ohms
Output Return Loss (Note 3)	> 14 dB within an active output channel from 108 MHz to 750 MHz > 13 dB within an active output channel from 750 MHz to 870 MHz > 12 dB within an active output channel from 870 MHz to 1218 MHz > 12 dB in every inactive channel from 54 MHz to 870 MHz > 10 dB in every inactive channel from 870 MHz to 1794 MHz

Parameter	Value
Table Notes:	
Note 1.	Receiver channel estimation is applied in the test receiver; test receiver does best estimation possible. Transmit windowing is applied to potentially interfering channel and selected to be sufficient to suppress cross channel interference.
Note 2.	MER (modulation error ratio) is determined by the cluster variance caused by the transmit waveform at the output of the ideal receive matched filter. MER includes all discrete spurious, noise, subcarrier leakage, clock lines, synthesizer products, distortion, and other undesired transmitter products. Phase noise up to ± 50 kHz of the subcarrier is excluded from inband specification, to separate the phase noise and inband spurious requirements as much as possible. In measuring MER, record length or carrier tracking loop bandwidth may be adjusted to exclude low frequency phase noise from the measurement. MER requirements assume measuring with a calibrated test instrument with its residual MER contribution removed.
Note 3.	Frequency ranges are edge-to-edge.
Note 4.	Phase noise up to 10 MHz offset is mitigated in test receiver processing or by test equipment (latter using hardline carrier from modulator, which requires special modulator test port and functionality).
Note 5.	Up to 5 subcarriers in one OFDM channel can be excluded from this requirement.
Note 6.	The measured OFDM channel is allocated 204.8 MHz of spectrum which is free from the other OFDM channel and 32 SC-QAM channels which together comprise 576 MHz of occupied bandwidth.
Note 7.	The estimated channel impulse response used by the test receiver is limited to half of length of smallest transmit cyclic prefix.
Note 8.	A single subcarrier in the OFDM channel can be excluded from this requirement, no windowing is applied, and minimum CP is selected.
Note 9.	Test limit includes 2 dB added to -60 dBc due to the contribution from the modulator noise floor which is allowed by spurious emissions.
Note 10.	CCAP spec approved and commonly used in CMTS/EQAM.
Note 11.	Commonly used in nodes.
Note 12.	When the Downstream Lower Band Edge is below 258 MHz, the occupied downstream spectrum is limited to 1,536 MHz. Therefore, the Downstream Upper Band Edge is not necessarily 1,794 MHz under these conditions.
Note 13.	Any frequencies transmitted by an FDD node below 258 MHz are intended for video SC-QAM and other non-DOCSIS signals.

7.3.5.9.1.1 Power per Channel for FDD RMD/RPD

Control over an FDD RMD/RPD's electrical output is required for many of the characteristics, such as RF channel power, number of RF channels, modulation characteristics of the channels, center frequency of channels, and so forth. Different mechanisms of control can exist for an FDD RMD/RPD and these mechanisms of control can be found in the DCA specifications. One possible mechanism of control is via commands carried in the downstream link into the FDD RMD/RPD, *Remote Node Control*. A second mechanism of control is *Local Node Control*, also referenced as "local-only", separate from the downstream link into the FDD RMD/RPD, such as an electrical interface operable at installation or even pluggable components set at installation. In an FDD RMD/RPD some adjustable characteristics can be controlled by one mechanism, and not the other, or by both; therefore, some "adjustable" characteristics can perhaps not be remotely changed. Local-only adjustments made at installation can be subsequently amended, but not remotely, and could incur service interruption.

An FDD RMD/RPD MUST be capable of generating 256 equivalent legacy DOCSIS channels, N_{eq} , onto the RF port at Interface C.

An FDD RMD/RPD has to be capable of generating a power per channel of at least 20 dBmV/6 MHz. The Channel Power Reference Setting (dBmV/6 MHz) of the FDD RMD/RPD could possibly be adjustable remotely, but is also permitted to be adjustable only locally, or even fixed (not adjustable), and serves as the reference power (0 dBc) for independently controlled individual channel power adjustment, and for spurious emissions.

The power per channel of the FDD RMD/RPD has to be adjustable for each channel independently, via remote adjustment, over a range of up to 10 dB below the Channel Power Reference Setting. An FDD RMD/RPD has to be adjustable to operate with fewer than $N_{eq} = 281$ channels on its RF port, for all N_{eq}' down to $N_{eq}' = 96$ channels. The FDD RMD/RPD has to comply with all requirements operating with all $N_{eq} = 281$ channels on the RF port, and has to comply with all requirements operating with N_{eq}' channels on the RF port for all values of N_{eq}' less than N_{eq} that it supports.

These specifications assume that the FDD RMD/RPD device will be terminated with a 75 ohm load.

An FDD RMD/RPD MUST generate an RF output with power capabilities as defined in Table 41 - FDD RMD/RPD Output Power.

The FDD RMD/RPD MUST be capable of adjusting channel RF power on a per channel basis as stated in Table 41 - FDD RMD/RPD Output Power.

The FDD RMD/RPD MUST be capable of adjusting power on a per channel basis for the legacy DOCSIS channels, with each channel independently meeting the power capabilities defined in Table 41 - FDD RMD/RPD Output Power.

Table 41 - FDD RMD/RPD Output Power

for N_{eq}' (number of active channels combined per RF port) in the range of 96 to 281	
Parameter	Value
Channel Power Reference Setting (Maximum required power, i.e., 0 dBc, per channel for N_{eq} ' channels combined onto a single RF port for an N_{eq} channel RPD):	Required power in dBmV per 6 MHz channel ≥ 20 dBmV (See item #1 in the requirements list immediately following this table) NOTES: No upper limit to the Channel Power Reference Setting which an RPD can provide No requirement for remote adjustability for Channel Power Reference Setting An RMD/RPD which has fixed Channel Power Reference Setting to meet full fidelity (Table 40, and Table 42 at that setting. (See item #2 in the requirements list immediately following this table) For FDD RMD/RPDs which have adjustable Channel Power Reference Setting, see the corresponding row in this table.
Range of Channel Power Reference Setting	may be adjustable locally An FDD RMD/RPD with adjustable Channel Power Reference Setting is to meet full fidelity (Table 40 and Table 42) whenever Channel Power Reference Setting is at or below 20 dBmV (See item #2 in the requirements list immediately following this table) For FDD RMD/RPD with Channel Power Reference Setting range which does not reach as low as 20 dBmV, the FDD RMD/RPD is to meet full fidelity with Channel Power Reference Setting at the lowest setting for the device. (See item #4 in the requirements list immediately following this table)
Range of commanded power per channel; adjusted on a per channel basis	CMTS 0 dBc to -2 dBc relative to Channel Power Reference Setting, via remote adjustment. larger variations than 2 dB below Channel Power Reference Setting, via remote adjustment are allowed. (See item #3 in the requirements list immediately following this table)
Commanded power per channel step size	≤ 0.2 dB Strictly monotonic
Power difference between any two adjacent channels in the 154 MHz to 1794 MHz downstream spectrum (with commanded power difference removed if channel power is independently adjustable and/or accounting for pilot density variation and subcarrier exclusions)	≤ 0.5 dB
Power difference between any two non-adjacent channels in a 48 MHz contiguous bandwidth block (with commanded power difference removed if channel power is independently adjustable)	≤ 1 dB

for N_{eq}' (number of active channels combined per RF port) in the range of 96 to 281	
Power difference (normalized for bandwidth) between any two channels OFDM channel blocks or legacy DOCSIS channels in the 258 MHz to 1794 MHz downstream spectrum (with commanded power difference removed if channel power is independently adjustable)	≤ 10 dB
Power per channel absolute accuracy	± 3 dB Table footnote: This specification contains a stability requirement which is much tighter than ± 3 dB.
Diagnostic carrier suppression (3 modes) Mode 1: One channel suppressed must be controlled remotely Mode 2: All channels suppressed except one must be controlled remotely Mode 3: All channels suppressed are to be controlled remotely	<p>1) ≥ 50 dB carrier suppression within the occupied bandwidth in any one active channel. When suppressing the carrier ≥ 50 dB within the occupied bandwidth in any one active channel the CMTS is to control transmissions such that no service impacting discontinuity or detriment to the unsuppressed channels occurs. (See item #5 in the requirements list immediately following this table)</p> <p>2) 50 dB carrier suppression within the occupied bandwidth in every active channel except one. The suppression is not required to be glitchless, and the remaining unsuppressed active channel is allowed to operate with increased power such as the total power of the N_{eq}' active channels combined.</p> <p>3) 50 dB carrier suppression within the occupied bandwidth in every active channel.</p> <p>The CMTS is to control transmissions such that in all three diagnostic carrier suppression modes the output return loss of the suppressed channel(s) complies with the Output Return Loss requirements for active channels given in Table 40 (See item #5 in the requirements list immediately following this table).</p> <p>The total noise and spur requirement is the combination of noise power from the 50 dBc suppressed channel and the normal noise and spur requirement for the CMTS output when operating with all channels unsuppressed.</p>
Table Note: Note 1. "Channel" in mode 1 or mode 2 carrier suppression refers to an OFDM channel with at least 22 MHz of contiguous modulated spectrum or an SC-QAM channel.	

The following is a list of FDD RMD/RPD RF Output Electrical Requirements based on Table 41 above.

1. An FDD RMD/RPD MUST support a Channel Power Reference Setting ≥ 20 dBmV.
 - An FDD RMD/RPD which has fixed Channel Power Reference Setting MUST meet full fidelity (Table 40 - FDD RMD/RPD RF Output Electrical Requirements and Table 42 - FDD RMD/RPD Output Out-of-Band Noise and Spurious Emissions Requirements) at that setting.
2. An FDD RMD/RPD MAY support a locally adjustable Range of Channel Power Reference Setting.
 - An FDD RMD/RPD with adjustable Channel Power Reference Setting MUST meet full fidelity (Table 40 - FDD RMD/RPD RF Output Electrical Requirements and Table 42 - FDD RMD/RPD Output Out-of-Band Noise and Spurious Emissions Requirements) whenever Channel Power Reference Setting is at or below: 20 dBmV.
 - For FDD RMD/RPD with Channel Power Reference Setting range which does not reach as low as 20 dBmV, the FDD RMD/RPD MUST meet full fidelity with Channel Power Reference Setting at the lowest setting for the device.
3. An FDD RMD/RPD MAY support a range of commanded power per channel, adjusted on a per channel basis, larger variations than 2 dB below Channel Power Reference Setting, via remote adjustment.

4. An FDD RMD/RPD MUST support a range of commanded power per channel, adjusted on a per channel basis, from 0 dBc to -2 dBc relative to Channel Power Reference Setting, via remote adjustment.
5. In an FDD RMD/RPD, Diagnostic carrier suppression (3 modes)
 - Mode 1: One channel suppressed to be controlled remotely - for this mode, the FDD CMTS MUST support ≥ 50 dB carrier suppression within the occupied bandwidth in any one active channel. When suppressing the carrier ≥ 50 dB within the occupied bandwidth in any one active channel, the FDD CMTS MUST control transmissions such that no service impacting discontinuity or detriment to the unsuppressed channels occurs.
 - Mode 2: All channels suppressed except one to be controlled remotely - for this mode, the FDD CMTS MUST support 50 dB carrier suppression within the occupied bandwidth in any one active channel except one. The suppression is not required to be glitchless, and the remaining unsuppressed active channel is allowed to operate with increased power such as the total power of the N_{eq} active channels combined.
 - Mode 3: All channels suppressed to be controlled remotely - for this mode, the FDD CMTS MUST support 50 dB carrier suppression within the occupied bandwidth in every active channel.
 - The FDD CMTS MUST control transmissions such that in all three diagnostic carrier suppression modes, the output return loss of the suppressed channel(s) complies with the Output Return Loss requirements for active channels given in Table 40 - FDD RMD/RPD RF Output Electrical Requirements.
6. When configured to mute an RF output port, the FDD RMD/RPD MUST control transmissions such that the output return loss of the output port of the muted device complies with the Output Return Loss requirements for inactive channels given in Table 40 - FDD RMD/RPD RF Output Electrical Requirements.

7.3.5.9.1.2 Out-of-Band Noise and Spurious Requirements for RMD/RPD

One of the goals of the [DOCSIS DRFI] specification is to provide the minimum intended analog channel CNR protection of 60 dB for systems deploying up to 119 DRFI-compliant QAM channels. A DOCSIS PHYv4.0 goal is to provide protection for legacy DOCSIS channels and for high density constellations of OFDM channel blocks if they are generated from another DRFI-compliant device.

The specification assumes that the transmitted power level of the digital channels will be 6 dB below the peak envelope power of the visual signal of analog channels, which is the typical condition for 256-QAM transmission. It is further assumed that the channel lineup will place analog channels at lower frequencies than digital channels, and in systems deploying DOCSIS 3.1 modulators, analog channels will be placed at center frequencies below 600 MHz. An adjustment of $10 \cdot \log_{10}(6 \text{ MHz} / 4 \text{ MHz})$ is used to account for the difference in a 6 MHz equivalent digital channel, versus an analog channel's noise power bandwidth. With the assumptions above, for a 119-6 MHz equivalent channel system, the specification in item 5 of Table 42 equates to an analog CNR protection of 60 dB.

With all digital channels at the same equivalent power per 6 MHz channel, the specification provides for 58 dB SNR protection for analog channels below 600 MHz (even with transmissions above 600 MHz) with 192 MHz occupied bandwidth (one full OFDM channel) and 51 dB SNR protection for digital channels below 600 MHz with transmission of 960 MHz modulated spectrum (160 equivalent legacy DOCSIS channels). The SNR protection between 600 MHz and 1002 MHz is 55 dB for analog channels operating above a 192 MHz occupied bandwidth generated by a DOCSIS 4.0 FDD compliant device, and is 48 dB between 600 MHz and 1002 MHz for digital channels operating above 960 MHz occupied bandwidth generated by a DOCSIS 4.0 FDD compliant device.

Table 42 lists the out-of-band spurious requirements. In cases where the N' combined channels are not commanded to the same power level, "dBc" denotes decibels relative to the strongest channel among the active channels. When commanded to the same power level, "dBc" should be interpreted as the average channel power, averaged over the active channels, to mitigate the variation in channel power across the active channels (see Table 42), which is allowed with all channels commanded to the same power.

The FDD RMD/RPD modulator MUST satisfy the out-of-band spurious emissions requirements of Table 42 - FDD RMD/RPD Output Out-of-Band Noise and Spurious Emissions Requirements, in measurements below 600 MHz

and outside the encompassed spectrum when the active channels are contiguous or when the ratio of modulated spectrum to gap spectrum within the encompassed spectrum is 4:1 or greater.

The FDD RMD/RPD modulator MUST satisfy the out-of-band spurious emissions requirements of Table 42 - FDD RMD/RPD Output Out-of-Band Noise and Spurious Emissions Requirements, with 1 dB relaxation, in measurements within gaps in modulated spectrum below 600 MHz and within the encompassed spectrum when the ratio of modulated spectrum to gap spectrum within the encompassed spectrum is 4:1 or greater.

The FDD RMD/RPD modulator MUST satisfy the out-of-band spurious emissions requirements of Table 42 - FDD RMD/RPD Output Out-of-Band Noise and Spurious Emissions Requirements, with 3 dB relaxation, when the ratio of modulated spectrum to gap spectrum within the encompassed spectrum is 4:1 or greater, in measurements with $603 \text{ MHz} \leq \text{center frequency} \leq 999 \text{ MHz}$, outside the encompassed spectrum or in gap channels within the encompassed spectrum.

The FDD RMD/RPD modulator MUST satisfy the out-of-band spurious emissions requirements of Table 42 - FDD RMD/RPD Output Out-of-Band Noise and Spurious Emissions Requirements, with 5 dB relaxation, when the ratio of modulated spectrum to gap spectrum within the encompassed spectrum is 4:1 or greater, in measurements with $999 \text{ MHz} < \text{center frequency} \leq 1215 \text{ MHz}$, outside the encompassed spectrum or in gap channels within the encompassed spectrum.

The FDD RMD/RPD modulator MUST satisfy the out-of-band spurious emissions requirements of Table 42 - FDD RMD/RPD Output Out-of-Band Noise and Spurious Emissions Requirements, with 5 dB relaxation, when the ratio of modulated spectrum to gap spectrum within the encompassed spectrum is 4:1 or greater, in measurements with $1215 \text{ MHz} < \text{center frequency} \leq 1791 \text{ MHz}$, outside the encompassed spectrum or in gap channels within the encompassed spectrum.

The FDD RMD/RPD modulator MUST satisfy the out-of-band spurious emissions requirements of Table 42 - FDD RMD/RPD Output Out-of-Band Noise and Spurious Emissions Requirements, in addition to contributions from theoretical transmit windowing, with permissible configurations of lower edge and upper edge sub-band exclusions of at least 1 MHz each, FFT Size, cyclic prefix length (N_{cp}) and windowing roll-off period (N_{rp}) values. Recommendations for configuration parameters are provided in Section 5.2.1.2. The test limit for determining compliance to the spurious emissions requirements is the power sum of the spurious emissions requirements taken in accordance with Table 42; and the contributions from the theoretical transmit windowing for the configured transmissions.

When the N_{eq} ' combined active channels are not contiguous, and the ratio of modulated spectrum to gap spectrum within the encompassed spectrum is 4:1 or greater, the spurious emissions requirements are determined by summing the spurious emissions power allowed in a given measurement bandwidth by each of the contiguous subblocks among the occupied bandwidth. In the gap channels within the encompassed spectrum and below 600 MHz there is a 1 dB relaxation in the spurious emissions requirements, so that within the encompassed spectrum the spurious emissions requirements (in absolute power) are 26% higher power in the measurement band determined by the summing of the contiguous subblocks' spurious emissions requirements. In all channels above 600 MHz there is a 3 dB relaxation in the spurious emissions requirements, so that the spurious emissions requirements (in absolute power) are double the power in the measurement band determined by the summing of the contiguous subblocks' spurious emissions requirements. The following three paragraphs provide the details of the spurious emissions requirements for non-contiguous channel operation outside the encompassed spectrum; within the encompassed spectrum the same details apply except there is an additional 1 dB allowance below 600 MHz; and 3 dB allowance is applied above 600 MHz for all channels.

The full set of N_{eq} channels is referred to throughout this specification as the modulated channels or the active channels. However, for purposes of determining the spurious emissions requirements for non-contiguous transmitted channels, each separate contiguous subblock of channels within the active channels is identified, and the number of channels in each contiguous subblock is denoted as $N_{eq,i}$, for $i = 1$ to K , where K is the number of contiguous subblocks. Therefore,

$$N'_{eq} = \sum_{i=1}^K N_{eq,i}$$

Note that $K = 1$ when and only when the entire set of active channels is contiguous. Also note that an isolated transmit channel, i.e., a transmit channel with empty adjacent channels, is described by $N_i = 1$ and constitutes a

subblock of one contiguous channel. Any number of the "contiguous subblocks" may have such an isolated transmit channel; if each active channel was an isolated channel, then $K = N'$.

When $N_{eq}' \geq N_{eq}/4$, Table 42 is used for determining the noise and spurious power requirements for each contiguous subblock, even if the subblock contains fewer than $N_{eq}/4$ active channels. When $N_{eq}' < N_{eq}/4$, Table 42 is used for determining the noise and spurious power requirements for each contiguous subblock. Thus, the noise and spurious power requirements for all contiguous subblocks of transmitted channels are determined from Table 42, where the applicable table is determined by N_{eq}' being greater than or equal to $N_{eq}/4$, or not. The noise and spurious power requirements for the i th contiguous subblock of transmitted channels is determined from Table 42 using the value N_i for the "number of active channels combined per RF port", and using "dBc" relative to the highest commanded power level of a 6 MHz equivalent channel among all the active channels, and not just the highest commanded power level in the i th contiguous subblock, in cases where the N_{eq}' combined channels are not commanded to the same power. The noise and spurious emissions power in each measurement band, including harmonics, from all K contiguous subblocks, is summed (absolute power, NOT in dB) to determine the composite noise floor for the non-contiguous channel transmission condition.

For the measurement channels adjacent to a contiguous subblock of channels, the spurious emissions requirements from the non-adjacent subblocks are divided on an equal "per Hz" basis for the narrow and wide adjacent measurement bands. For a measurement channel wedged between two contiguous subblocks, adjacent to each, the measurement channel is divided into three measurement bands, one wider in the middle and two narrower bands each abutting one of the adjacent transmit channels. The wideband spurious and noise requirement is split into two parts, on an equal "per Hz" basis, to generate the allowed contribution of power to the middle band and to the farthest narrowband. The ceiling function is applied to the resulting sum of noise and spurious emissions, per the first Note in Table 42 to produce a requirement of 1/2 dB resolution.

Items 1 through 4 list the requirements in channels adjacent to the commanded channels.

Item 5 lists the requirements in all other channels further from the commanded channels. Some of these "other" channels are allowed to be excluded from meeting the Item 5 specification. All the exclusions, such as 2nd and 3rd harmonics of the commanded channel, are fully identified in Table 42.

Item 6 lists the requirements on the $2N'$ 2nd harmonic channels and the $3N'$ 3rd harmonic channels.

Table 42 - FDD RMD/RPD Output Out-of-Band Noise and Spurious Emissions Requirements

For N_{eq}' (number of active channels combined per RF port) in the range of 96 to 281		
	Band	Requirement (in dBc)
1	Adjacent channel up to 750 kHz from channel block edge	For $N^* = 1, 2, 3, 4: \leq -58$; For $N^* \geq 5: \leq 10^* \log_{10} [10^{-58/10} + (0.75/6)^*(10^{-65/10} + (N^*-2)*10^{-73/10})]$
2	Adjacent channel (750 kHz from channel block edge to 6 MHz from channel block edge)	For $N^* = 1: \leq -62$; For $N^* \geq 2: \leq 10^* \log_{10} [10^{-62/10} + (5.25/6)^*(10^{-65/10} + (N^*-2)*10^{-73/10})]$
3	Next-adjacent channel (6 MHz from channel block edge to 12 MHz from channel block edge)	$\leq 10^* \log_{10} [10^{-65/10} + (N^*-1)*10^{-73/10}]$
4	Third-adjacent channel (12 MHz from channel block edge to 18 MHz from channel block edge)	For $N^* = 1: \leq -73$; For $N^* = 2: \leq -70$; For $N^* = 3: \leq -67$; For $N^* = 4: \leq -65$; For $N^* = 5: \leq -64.5$; For $N^* = 6, 7: \leq -64$; For $N^* \geq 8: \leq -73 + 10^* \log_{10} (N^*)$
5	Noise in other channels (47 MHz to 1794 MHz) Measured in each 6 MHz channel excluding the following: a) Desired channel(s) b) 1st, 2nd, and 3rd adjacent channels (see Items 1, 2, 3, 4 in this table) c) Channels coinciding with 2nd and 3rd harmonics (see Item 6 in this table)	For $N^* = 1: \leq -73$; For $N^* = 2: \leq -70$; For $N^* = 3: \leq -68$; For $N^* = 4: \leq -67$; For $N^* \geq 5: \leq -73 + 10^* \log_{10} (N^*)$

For N_{eq} ' (number of active channels combined per RF port) in the range of 96 to 281		
	Band	Requirement (in dBc)
6	In each of $2N_{eq}$ ' contiguous 6 MHz channels or in each of $3N'$ contiguous 6 MHz channels coinciding with 2nd harmonic and with 3rd harmonic components respectively (up to 1218 MHz)	$\leq -73 + 10 \cdot \log_{10}(N^*)$ dBc, or -63, whichever is greater
7	Lower out of band noise in the band of 5 MHz to 47 MHz Measured in 6 MHz channel bandwidth	$\leq -50 + 10 \cdot \log_{10}(N^*)$
8	Higher out of band noise in the band of 1794 MHz to 3000 MHz Measured in 6 MHz channel bandwidth	For $N^* \leq 8$: $\leq -55 + 10 \cdot \log_{10}(N^*)$ For $N^* > 8$: $\leq -60 + 10 \cdot \log_{10}(N^*)$
Table Notes: Note 1. All equations are Ceiling(Power, 0.5) dBc. Use "Ceiling(2*Power) / 2" to get 0.5 steps from ceiling functions that return only integer values. For example, Ceiling(-63.9, 0.5) = -63.5 dBc. Note 2. Add 3 dB relaxation to the values specified above for noise and spurious emissions requirements in all channels with $603 \text{ MHz} \leq \text{center frequency of the noise measurement} \leq 999 \text{ MHz}$. For example, -73 dBc becomes -70 dBc. Add 5 dB relaxation to the values specified above for noise and spurious emissions requirements in all channels with $999 \text{ MHz} < \text{center frequency of the noise measurement} \leq 1791 \text{ MHz}$. For example, -73 dBc becomes -68 dBc. Note 3. Add 1 dB relaxation to the values specified above for noise and spurious emissions requirements in gap channels with center frequency below 600 MHz. For example, -73 dBc becomes -72 dBc.		

7.3.5.10 Independence of Individual Channels Within Multiple Channels on a Single RF Port

See [DOCSIS PHYv3.1], section 7.5.10.

7.3.5.11 Cable Modem Receiver Input Requirements

For FDD devices operating in FDD mode, this section augments section 7.5.11 of [DOCSIS PHYv3.1] and corresponding subsections unless otherwise noted.

The FDD CM MUST be able to accept any range of OFDM subcarriers defined between Lower Frequency Boundary and Upper Frequency Boundary simultaneously.

Active subcarrier frequencies, loading, and other OFDM characteristics are described by OFDM configuration settings and CM exclusion bands and profile definition. The OFDM signals and CM interfaces will have the characteristics and limitations defined in Table 43.

The FDD CM MUST support the requirements in Table 43 - Electrical Input to FDD CM, which supersedes the corresponding requirements in [DOCSIS PHYv3.1], table 45 - Electrical Input to CM, unless otherwise noted.

Table 43 - Electrical Input to FDD CM

Parameter	Value
Lower Band Edge	As selected from Table 31
Upper Band Edge	1794 MHz
Frequency Boundary Assignment Granularity	25 kHz 8K FFT 50 kHz 4K FFT
Signal Type	OFDM, SC-QAM
Maximum Single OFDM Channel Bandwidth	192 MHz
Minimum Contiguous-Modulated OFDM Bandwidth	22 MHz
Number of Channels	Support minimum of 5 OFDM Channels AND 32 SC-QAM Channels
Subcarrier Spacing/FFT Duration	25 kHz / 40 μ s 50 kHz / 20 μ s
Modulation Type	QPSK, 16-QAM, 64-QAM, 128-QAM, 256-QAM, 512-QAM, 1024-QAM, 2048-QAM, 4096-QAM
Variable Bit Loading	Support with subcarrier granularity Support zero-bit-loaded subcarriers

Parameter	Value
Total Input Power	< 40 dBmV, 54 MHz to 1794 MHz * Assuming negligible power outside this range
Level Range (24 MHz min occupied BW) Equivalent PSD to SC-QAM of -30 dBmV to + 15 dBmV per 6 MHz	-24 dBmV/24 MHz to 21 dBmV/24 MHz
Maximum average power per MHz input to the CM from 258 MHz to 1794 MHz (dBmV/MHz)	Let X = Average power of lowest power 24 MHz of modulated spectrum for demodulation Additional Demodulated Bandwidth, Bdemod: $\leq \text{Min} [X - 10 \cdot \log_{10}(24) + 12; 21 - 10 \cdot \log_{10}(24)]$ Additional Non-Demodulated Bandwidth, Bno-demod : $\leq \text{Min} [X - 10 \cdot \log_{10}(24) + 12; 26 - 10 \cdot \log_{10}(24)]$ For up to 12 MHz of occupied bandwidth (analog, OOB, QAM, OFDM) $\leq \text{Min} [X - 10 \cdot \log_{10}(24) + 12; 21 - 10 \cdot \log_{10}(24)]$ for all remaining bandwidth NOTE: Level range does not imply anything about BER performance or capability vs. QAM. CM BER performance is separately described.
Input Impedance	75 ohms
Input Return Loss	> 6 dB within the selected downstream frequency range
Connector	F connector per [ISO/IEC-61169-24] or [SCTE 02]

7.3.5.12 FDD Cable Modem Receiver Capabilities

The required level for FDD CM downstream post-FEC error ratio is defined as less than or equal to 10^{-6} PER (packet error ratio) with 1500-byte Ethernet packets. This section describes the conditions at which the FDD CM is required to meet this error ratio.

7.3.5.12.1 CM Error Ratio Performance in AWGN Channel

For FDD operation the FDD CM is required to support a downstream upper band edge of 1794 MHz (see Section 7.3.2.1). The FDD CM CNR requirements are defined for two different cases of the input downstream signal upper limit: 1218 MHz and 1794 MHz. The downstream signal upper limit in this context means that there will be negligible energy above this frequency at the CM input. For example, in the case of 1218 MHz, there will be no channel or part of the channel above 1218 MHz either desired or undesired. This could occur if the FDD CM is operating in a cable plant that only supports downstream signals up to 1218 MHz or if the operator chooses not to provide downstream signals above 1218 MHz. The downstream lower band edge depends on the supported duplex filter option and can be one of the following: 258, 372, 492, 606, or 834 MHz.

The FDD CM MUST achieve the required error ratio when operating at a CNR as shown in Table 44 - CM Minimum CNR Performance¹ in AWGN Channel for 1218 MHz Input Signal Upper Frequency Limit and Table 45 - CM Minimum CNR Performance¹ in AWGN Channel for 1794 MHz Input Signal Upper Frequency Limit, under input load and channel conditions as follows:

- Any valid transmit combination (frequency, subcarrier clock frequency, transmit window, cyclic prefix, pilot, PLC, subcarrier exclusions, interleaving depth, multiple modulation profile configuration, etc.) as defined in this spec.
- P_{6AVG} (the measured channel power divided by number of occupied CTA channels) ≤ 15 dBmV.
- Up to fully loaded spectrum of 54 MHz to 1794 MHz, including up to 48 analog channels placed lower in the spectrum than the digital channels.
- Power in (both above and below) 4 adjacent 6 MHz channels $\leq P_{6AVG} + 3$ dB.
- 5 Power in any 6 MHz channel over the spectrum $\leq P_{6AVG} + 6$ dB.

- Peak envelope power in any analog channel over the spectrum $P_{6AVG}+6$ dB.
- Average power per channel across spectrum $P_{6AVG}+3$ dB.
- OFDM channel phase noise for the FDD Node (Table 40 - FDD RMD/RPD RF Output Electrical Requirements).
- No other artifacts (reflections, burst noise, tilt, etc.).
- The Upstream transmit power is within the allowable range and no Upstream channel in the TCS FDD exceeds the $P_{ref-FDD}$.

Table 44 - CM Minimum CNR Performance¹ in AWGN Channel for 1218 MHz Input Signal Upper Frequency Limit

Constellation	CNR ^{2,3,4} (dB) Up to 1002 MHz	CNR ^{2,3,4} (dB) 1002 MHz to 1218 MHz	Min P _{6AVG} dBmV
4096	41.0	41.5	-6
2048	37.0	37.5	-9
1024	34.0	34.0	-12
512	30.5	30.5	-12
256	27.0	27.0	-15
128	24.0	24.0	-15
64	21.0	21.0	-15
16	15.0	15.0	-15

Table Notes:
 Note 1. Applicable to an OFDM channel with 192 MHz of occupied bandwidth.
 Note 2. CNR is defined here as total signal power in occupied bandwidth divided by total noise in occupied bandwidth.
 Note 3. Channel CNR is adjusted to the required level by measuring the source inband noise including phase noise component along with transmitter noise and distortion and adding the required delta noise from an external AWGN generator to achieve the desired CNR at the CM F-connector.
 Note 4. The CNR defined in this table is applicable when the cable plant or operator configuration limits downstream signals to below 1218 MHz and is, therefore, applicable from its lower band edge to 1218 MHz.

Table 45 - CM Minimum CNR Performance¹ in AWGN Channel for 1794 MHz Input Signal Upper Frequency Limit

Constellation	CNR ^{2,3,4} (dB) Up to 1794 MHz	Min P _{6AVG} dBmV
4096	41	0
4096	44.0	-6
2048	37	-6
2048	40.0	-9
1024	36.0	-12
512	33	-15
256	30	-18
128	28	-21
64	26	-24
16	20	-27

Constellation	CNR ^{2,3,4} (dB) Up to 1794 MHz	Min P _{6AVG} dBmV
<p>Table Notes:</p> <p>Note 1. Applicable to an OFDM channel with 192 MHz of occupied bandwidth.</p> <p>Note 2. CNR is defined here as total signal power in occupied bandwidth divided by total noise in occupied bandwidth.</p> <p>Note 3. Channel CNR is adjusted to the required level by measuring the source inband noise including phase noise component along with transmitter noise and distortion and adding the required delta noise from an external AWGN generator to achieve the desired CNR at the CM F-connector.</p> <p>Note 4. The CNR defined in this table is applicable in the entire downstream band from its lower band edge to 1794 MHz.</p>		

7.3.5.13 Physical Layer Link Channel (PLC)

See [DOCSIS PHYv3.1], section 7.5.13.

7.3.5.14 Next Codeword Pointer

See [DOCSIS PHYv3.1], section 7.5.14.

7.3.5.15 Downstream Pilot Patterns

See [DOCSIS PHYv3.1], section 7.5.15.

8 PHY-MAC CONVERGENCE

See [DOCSIS PHYv3.1], section 8.

9 PROACTIVE NETWORK MAINTENANCE

See [DOCSIS PHYv3.1], section 9.

Appendix I ICI from CWT Sounding Signal (Informative)

I.1 ICI Caused by Sounding Signal on Adjacent US Subcarriers

Given that the sounding CW does not coincide exactly on OFDM subcarrier center frequency (FFT grid points), the sounding signal CW will cause inter-carrier interferences (ICI) to the adjacent subcarriers on US.

To minimize the impact of ICI caused by the sounding signal, one may need to adjust the profiles on the adjacent subcarriers, if they are active subcarriers, to ensure that their normal operations will not be affected. The actual ICI depends on the sounding power and the frequency offset value selected during the sounding procedure. As all noise is additive, the effective noise floor N_{eff} will be $10 \cdot \log_{10}(10^{(-N_{\text{ICI}}/10)} + 10^{(-N_0/10)})$; where N_{ICI} is the noise floor contributed by ICI and N_0 is the original noise floor without the sounding signal.

For example, in the case of 25 kHz subcarrier spacing, if the sounding CWs are transmitted with 10 dB power boost and a 150 Hz frequency (the worst case), then the ICI to the closest subcarrier and adjacent subcarriers will be 35 dB and 40 dB below their nominal US received signal (tone power), limiting their SNR to 35 dB and 40 dB, respectively. Once N_{eff} is calculated, the corresponding SNR and QAM orders can be derived.

As the power boosting and frequency offset values are field configurable, the QAM orders on the closest and adjacent subcarriers vary. To simplify the operation and be conservative, one could set their QAM orders always based on the worst case (ICI is 35 dB and 40 dB, respectively, for 25 kHz carrier spacing, and 40 dB and 45 dB, respectively, for 50 kHz carrier spacing).

The ICI on 3rd adjacent subcarrier is 55 dB and 60 dB for 25 kHz and 50 kHz carrier spacing, respectively. Even with the max 10 dB sounding power boosting, the noise contribution by the ICI will be 45 dB and 55 dB below the nominal US power. In addition, the marginal adverse ICI effects on 3rd subcarrier can be mitigated by the frequency interleaving. Thus, the effects of ICI on the 3rd adjacent subcarrier and beyond can be ignored.

The maximum number of sounding signals is 255 per US OFDMA channel. The ICI contributions from adjacent sounding signals, other than the closest one, can be ignored.

I.2 ICI Caused by Sounding Signal on Adjacent DS Subcarriers

The impact of ICI caused by the sounding signal on adjacent subcarriers on the DS can be evaluated in a similar way as US. As the CM is not able to send a sounding signal and receive the DS signal at the same time, the impacts of ICI caused by sounding signal are on the DS of neighboring CMs.

The sounding signal received by the neighboring CM could be as high as 7 dB above the nominal DS received signal level (tone power). With 10 dB sounding power boosting, the max sounding signal received by the neighboring CM will be 17 dB above the nominal DS received signal level.

To mitigate the impact of the ICI on DS caused by the sounding signal, one may need to adjust the profiles on the adjacent subcarriers to ensure that their normal operations will not be affected. The actual ICI depends on the sounding power and the frequency offset value selected during the sounding procedure.

Refer to Table 46, where the ICI is listed for 10 direct adjacent subcarriers with 25 kHz carrier spacing and 150 Hz sounding signal frequency offset (worst case). When the sounding signal level is 17 dB above the nominal DS signal level, the noise contribution from ICI on the first adjacent subcarrier will be 27 dB below the DS nominal signal level. Similar to US, one needs to add up all the noises to compute the effective noise floor from which the effect SNR and QAM order will be derived. The ICI is about 47 dB below the nominal DS signal level on 10th adjacent subcarrier for the worst case (10 dB sounding signal boosting, 25 kHz carrier spacing and 150 Hz sounding signal frequency offset), which is 6 dB below the noise floor for supporting the max 41 dB SNR required for DS. The impact of the ICI on 11th subcarrier and beyond can be ignored.

Table 46 - Inter-Carrier Interference

Inter-Carrier Interference (dB) (25 kHz carrier spacing, 150 Hz freq offset)		
Adjacent carrier index	Sounding signal equals DS signal of neighboring CM	Sounding signal 17 dB above DS signal of neighboring CM
0	0.0	17.0
1	-44.4	-27.4
2	-50.4	-33.4
3	-54.4	-37.0
4	-56.4	-39.5
5	-58.4	-41.4
6	-60.0	-43.0
7	-61.3	-44.3
8	-62.5	-45.5
9	-63.5	-46.5
10	-64.4	-47.4

The maximum number of sounding signals is 254 per US OFDMA channel. So, the minimum interval between sounding signal is 8 subcarriers. If one needs to consider the ICI up to 10 subcarriers, when 254 sounding signals are activated on each DS subcarrier, the ICI will be contributed by up to three adjacent sounding signals. Most likely, the adjacent sounding signals come from different CMs, and their ICI will be additive. In this case, the effective noise floor N_{eff} on the victim DS subcarrier will be $10 \cdot \log_{10}(10(-N_{ICI_a}/10) + 10(-N_{ICI_b}/10) + 10(-N_{ICI_c}/10) + 10(-N_0/10))$; where N_{ICI_a} , N_{ICI_b} and N_{ICI_c} are the noise floors contributed by the ICI of three sounding signals (signals a, b, and c) that are separate from the victim DS subcarrier by less than 10 subcarriers; and N_0 is the original noise floor without any sounding signals. Once N_{eff} is calculated, the corresponding SNR and QAM orders will be derived.

The ICI contributions from fourth sounding signal and beyond can be ignored.

For channel sounding purposes, multiple subcarriers are assigned to be sounding subcarriers where modems can transmit continuous wave (CW) signals and other modems receive and measure those CW signals. By knowing the transmit and receive levels of the sounding subcarriers, the RF isolation between CMs as a function of frequency can be calculated.

The sounding subcarriers cannot be PLC, NCP, continuous pilot, or exclusion subcarriers. The CMTS sets the modulation of DS data subcarriers with the same frequency as sounding CWs to "zero bit-loading" for the duration of the sounding test. In the sounding test, one or more CMs transmit the sounding CWs with a small frequency offset from the subcarrier center frequency of the DS channel. For any CM that is to receive and measure the sounding CWs, the direction of the channel that is being sounded is to be switched to DS direction from the view point of that CM.

CMs will only measure the SNR of a sounding CW when the sounding subcarrier coincides with the location of a scattered pilot. Note that FDX-L CMs can use FDX channels as DS channels only. Therefore, they participate in the sounding process in listen-only mode. FDX CMs can use FDX channels for either direction.

Appendix II Example Use of CWT Sounding to Form IGs (Informative)

The FDX CMTS can use the MER measurements collected from the modems operating in the FDX band to form IGs. An example of that procedure is provided below:

- The FDX CMTS asks CM to report MER twice during each sounding operation:
First, prior to introducing CW tones, MER_{pre_CW} ; then, after introducing CW tones and having allowed CM enough time to work out new MER values, MER_{CW} .
- The FDX CMTS then derives MER at CM due to CW power alone, $MER_{CMTSderived}$, combining the two MER measurements, MER_{pre_CW} and MER_{CW} , reported by CM.

$$MER_{CMTSderived} = -10 * \log_{10}(10^{-MER_{CW}/10} - 10^{-MER_{pre_CW}/10})$$

- The FDX CMTS compensates for the K_{is_boost} value by adjusting the CMTS calculated MER value, derived from the CM reported MERs, during sounding operation as follows:

$$MER_{adjusted} = MER_{CMTSderived} - K_{is_boost}$$

- The FDX CMTS compensates for the K_{ps_boost} value by adjusting the modem reported MER values collected during the periodic sounding operation as follows:

$$MER_{adjusted} = MER_{CMTSderived} - K_{ps_boost}$$

Appendix III CMTS Proposed Configuration Parameters (Informative)

Table 47 - CMTS Proposed Configuration Parameters

FFT	Roll-Off Period Samples (N _{rp})	Taper Region (MHz)
4K	64	3.575
	128	1.875
	192	1.325
	256	0.975
8K	64	3.3375
	128	1.7125
	192	1.1625
	256	0.9875 ¹
Table Note: Note 1. The taper region of 0.9875 MHz is in accordance with the requirement for a minimum taper region of 1 MHz minus half subcarrier spacing. Achieving up to approximately 0.5 dB impact to the noise power in the adjacent spurious emissions integration region would allow a taper region of 0.8625 MHz, if the specification did not mandate the minimum taper region to be larger than this.		

The taper region consists of the spectrum extending from a) the spectral edge of the encompassed spectrum, to b) the frequency above (or below) the edge of the encompassed spectrum by the amount (MHz) as given in the third column of Table 47.

The spectral edge of the taper region which is opposite the spectral edge adjacent to the encompassed spectrum, falls on the center frequency of an inactive subcarrier in the Bandedge Exclusion Sub-band. When the spectral edge of a taper region of an OFDM signal falls on a CEA channel boundary, the CEA channel containing the taper region is an occupied CEA channel (of that OFDM signal) and the other CEA channel, which abuts the taper region, is not an occupied channel of that OFDM signal.

Appendix IV FDD RPD/RMD RF Output Profiles at Interface C (Informative)

Please refer to Figure 24 which shows reference interfaces on an FDD node. Figure 27 shows an example of an Interface C output.

The Node RF launch amplifier shown in Figure 24 generally both applies tilt or slope to the signal at Interface C and raises the signal level as that signal is launched (Interface D) onto the hardline coaxial cable network. The total composite power (TCP) at Interface D is expected to be at least 70 dBmV.

Within the node at Interface C, the RMD/RPD generally outputs either a flat or a stepped signal. The output at interface C could also be tilted and these cases are not addressed in this Appendix. The Interface C output minimally is 20 dBmV. The output is referred to as the channel power reference setting. At Interface C, power can be adjusted per channel, and the largest required change from the channel power reference setting for any channel is -10 dBc.

Levels at Interface C can be adjustable both up and down on a channel by channel basis, within the boundaries of the Interface D total composite power setting, and the channel definition within this DOCSIS 4.0 specification.

Channel power adjustments result from at least three considerations.

1. Maintaining power levels for legacy CPE (e.g., digital video set-top boxes and early versions of DOCSIS modems), of which modern equipment operates to 1002 MHz but could be lower.
2. Providing as much power as possible for DOCSIS 4.0 modems out to 1794 MHz or as far as the operator chooses to operate the plant.
3. Optimizing total composite power out of the fiber node with a desired power tilt level at Interface D to overcome cable loss, such that the node launch amplifier is not overdriven.

With the above, and possibly other considerations, there are many possibilities of waveforms at both Interface C and D and the intent of this Appendix is to provide just a few examples.

Figure 28 shows an example transmission profile at interface C, and specifically a change in channel power at 1218 MHz, between OFDM channel 3 and OFDM channel 4. Changes in power level can only occur on channel boundaries. In this example, the channel power reference setting is 20 dBmV and a single step of -10 dBc is applied to channels above 1218 MHz.

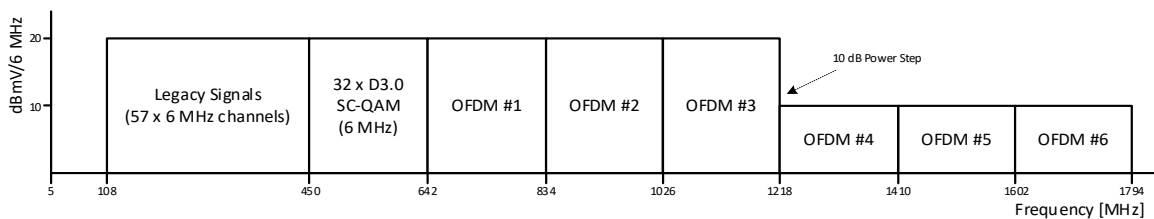

Figure 28 - Example Transmission Profile at Interface C (Single Step-down at 1218 MHz)

The step is to occur on channel boundaries. The frequency location in the spectrum a step occurs will be determined by product requirements provided by operators.

Figure 29 shows multiple steps applied at Interface C. Note that all steps occur on channel boundaries and that the lowest channel power is -10 dBc as compared to the channel power reference setting.

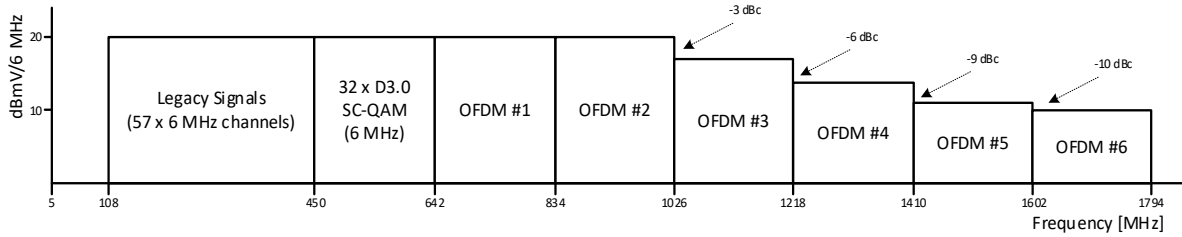

Figure 29 - Example Transmission Profile at Interface C (Multiple Step-down)

Figure 30 shows a step-up for a channel.

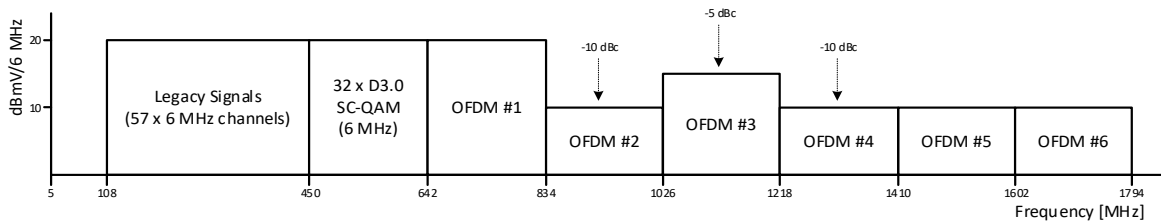

Figure 30 - Example Transmission Profile at Interface C (Step-up)

Figure 31 contains an example where the step is placed at 1002 MHz, and in this case the OFDM channels at higher frequencies will end at 1770 MHz (not 1794 MHz).

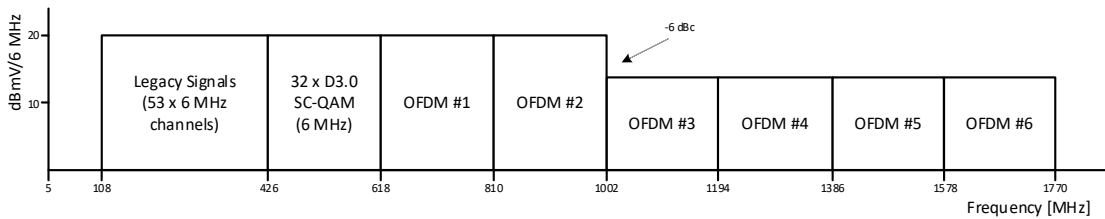

Figure 31 - Example Transmission Profile at Interface C (Single 6-dB Step-down at 1002 MHz)

Appendix V Acknowledgements (Informative)

On behalf of the cable industry and our member companies, CableLabs would like to thank the numerous individuals that contributed to the development of this specification. In particular, we want to extend our sincere appreciation and gratitude to the following team members for their contributions in developing the DOCSIS 4.0 Physical Layer specification:

Contributor	Company Affiliation
Kevin Schneider	Adtran
Andy Boyce	Analog Devices
Ayham Al-Banna, Tom Cloonan, Frank O'Keeffe	ARRIS/Commscope
Brad Nikkari	ATX
Roger Fish, Avi Kliger, Tom Kolze, Leo Montreuil, Niki Pantelias, Rich Prodan	Broadcom
Bernard Arambepola, Belal Hamzeh, Kevin Luehrs, Sheldon Webster, Tom Williams, Doug Jones, Curtis Knittle, Karthik Sundaresan	CableLabs
Ariel Yagil, Daniel Wajcer	Capacicom
Lee Andrews, Tao Yu	Casa Systems
David Claussen, Roger Stafford, Shlomo Ovadia, Philip Anderson	Charter Communications
John Chapman, Hang Jin, Tong Liu, John Ritchie, Jr., Mike Whitley, Ron Hranac, Richard Piper	Cisco Systems
Maurice Garcia, Rob Howald, Phil Miguelez, Saifur Rahman, Jorge Salinger, Joe Solomon, Rob Thompson, Rich Prodan	Comcast
Michael Cooper, Jeff Finkelstein, Bill Wall, David Job	Cox Communications
Adi Bonen	Harmonic
Jim Chen, Karl Moerder, Jack Moran, Marc Morrisette, Toy Ouyangtao, Syed Rahman,	Huawei
David Barr, Thushara Hewavithana, Boaz Kol, Satish Mudugere, Shaul Shulman	Intel
Shannon Horwitz, Ajay Kuckreja	Maxim Integrated
Steve Krapp, Sridhar Ramesh, Eitan Tsur, Scott Walley	MaxLinear
Werner Coomans, Bill Powell, Nathalie Tal, Rex Coldren	Nokia/Gainspeed
George Hart	Rogers Communications
Dean Stoneback, Nick Segura	SCTE
David Young	SED Systems
Craig Hrycoy, Nader Foroughi	Shaw
Sergey Egorov, Perttu Fagerlund	Teleste
Brian Berscheid, Colin Howlett	Vecima Networks

Appendix VI Revision History (Informative)

The following Engineering Change was incorporated into CM-SP-CM-PHYv4.0-I02-200429.

ECN Identifier	Accepted Date	Title of EC	Author
CM-PHYv4.0-N-20.2080-5	03/26/2020	Omnibus EC for adding FDD functionality to PHYv4.0	Webster

The following Engineering Changes were incorporated into CM-SP-CM-PHYv4.0-I03-201202.

ECN Identifier	Accepted Date	Title of EC	Author
PHYv4.0-N-20.2111-2	08/13/2020	Clarification of 7.3.5.12.1 - CM Error Ratio Performance in AWGN Channel	Froimovich
PHYv4.0-N-20.2112-2	08/27/2020	Downstream FDD Node Spectrum	Anderson
PHYv4.0-N-20.2129-3	11/05/2020	Clarification of Operation with 204 MHz Split	Froimovich
PHYv4.0-N-20.2130-1	11/05/2020	Boosted Reference PSD for Smaller FDD Bands	Froimovich
PHYv4.0-N-20.2134-2	11/18/2020	FDD RMD/RPD Receiver Capabilities - Interface C	Young

* * *