

Data-Over-Cable Service Interface Specifications DOCSIS® 3.1

Security Specification

CM-SP-SECv3.1-I04-150910

ISSUED

Notice

This DOCSIS specification is the result of a cooperative effort undertaken at the direction of Cable Television Laboratories, Inc. for the benefit of the cable industry and its customers. You may download, copy, distribute, and reference the documents herein only for the purpose of developing products or services in accordance with such documents, and educational use. Except as granted by CableLabs® in a separate written license agreement, no license is granted to modify the documents herein (except via the Engineering Change process), or to use, copy, modify or distribute the documents for any other purpose.

This document may contain references to other documents not owned or controlled by CableLabs. Use and understanding of this document may require access to such other documents. Designing, manufacturing, distributing, using, selling, or servicing products, or providing services, based on this document may require intellectual property licenses from third-parties for technology referenced in this document. To the extent this document contains or refers to documents of third parties, you agree to abide by the terms of any licenses associated with such third party documents, including open source licenses, if any.

© Cable Television Laboratories, Inc. 2014-2015

DISCLAIMER

This document is furnished on an "AS IS" basis and neither CableLabs nor its members provides any representation or warranty, express or implied, regarding the accuracy, completeness, noninfringement, or fitness for a particular purpose of this document, or any document referenced herein. Any use or reliance on the information or opinion in this document is at the risk of the user, and CableLabs and its members shall not be liable for any damage or injury incurred by any person arising out of the completeness, accuracy, or utility of any information or opinion contained in the document.

CableLabs reserves the right to revise this document for any reason including, but not limited to, changes in laws, regulations, or standards promulgated by various entities, technology advances, or changes in equipment design, manufacturing techniques, or operating procedures described, or referred to, herein.

This document is not to be construed to suggest that any company modify or change any of its products or procedures, nor does this document represent a commitment by CableLabs or any of its members to purchase any product whether or not it meets the characteristics described in the document. Unless granted in a separate written agreement from CableLabs, nothing contained herein shall be construed to confer any license or right to any intellectual property. This document is not to be construed as an endorsement of any product or company or as the adoption or promulgation of any guidelines, standards, or recommendations.

Document Status Sheet

Document Control Number	CM-SP-SECv3.1-I04-150910			
Document Title	Security Specification			
Revision History	I01 - Released 10/23/14 I02 - Released 03/26/15 I03 - Released 06/11/15 I04 - Released 09/10/15			
Date	September 10, 2015			
Status	Work in Progress	Draft	Issued	Closed
Distribution Restrictions	DOCSIS 3.0 Focus Teams	CL/Member	CL/Member/ Vendor	Public

Key to Document Status Codes

Work in Progress	An incomplete document, designed to guide discussion and generate feedback that may include several alternative requirements for consideration.
Draft	A document in specification format considered largely complete, but lacking review by Members and vendors. Drafts are susceptible to substantial change during the review process.
Issued	A generally public document that has undergone Member and Technology Supplier review, cross-vendor interoperability, and is for Certification testing if applicable. Issued Specifications are subject to the Engineering Change Process.
Closed	A static document, reviewed, tested, validated, and closed to further engineering change requests to the specification through CableLabs.

Trademarks

CableLabs® is a registered trademark of Cable Television Laboratories, Inc. Other CableLabs marks are listed at <http://www.cablelabs.com/certqual/trademarks>. All other marks are the property of their respective owners.

Contents

1	SCOPE	11
1.1	Introduction and Purpose	11
1.2	Background.....	11
1.2.1	<i>Broadband Access Network</i>	11
1.2.2	<i>Network and System Architecture</i>	11
1.2.3	<i>Service Goals</i>	13
1.2.4	<i>Statement of Compatibility</i>	13
1.2.5	<i>Reference Architecture</i>	14
1.2.6	<i>DOCSIS 3.1 Documents</i>	14
1.3	Requirements	15
1.4	Conventions	15
2	REFERENCES	16
2.1	Normative References.....	16
2.2	Informative References.....	18
2.3	Reference Acquisition.....	18
3	TERMS AND DEFINITIONS	19
4	ABBREVIATIONS AND ACRONYMS	20
5	OVERVIEW	23
5.1	New DOCSIS 3.1 Security Features	23
5.1.1	<i>BPI+ Architecture</i>	24
5.1.2	<i>Secure Provisioning</i>	26
5.2	Operation	26
5.2.1	<i>Cable Modem Initialization</i>	26
5.2.2	<i>Cable Modem Key Update Mechanism</i>	28
5.2.3	<i>Cable Modem Secure Software Download</i>	28
6	ENCRYPTED DOCSIS MAC FRAME FORMATS	29
6.1	CM Requirements	29
6.2	CMTS Requirements	29
6.3	Variable-Length PDU MAC Frame Format	29
6.3.1	<i>Baseline Privacy Extended Header Formats</i>	31
6.4	Fragmentation MAC Frame Format	32
6.5	Registration Request (REG-REQ-MP) MAC Management Messages.....	33
6.6	Use of the Baseline Privacy Extended Header in the MAC Header	35
7	BASELINE PRIVACY KEY MANAGEMENT (BPKM) PROTOCOL	36
7.1	State Models	36
7.1.1	<i>Introduction</i>	36
7.1.2	<i>Encrypted Multicast</i>	39
7.1.3	<i>Selecting Cryptographic Suites</i>	41
7.1.4	<i>Authorization State Machine</i>	41
7.1.5	<i>TEK State Machine</i>	48
7.2	Key Management Message Formats.....	54
7.2.1	<i>Packet Formats</i>	54
7.2.2	<i>BPKM Attributes</i>	60
8	EARLY AUTHENTICATION AND ENCRYPTION (EAE)	75
8.1	Introduction	75
8.2	EAE Signaling	75

8.3	EAE Encryption.....	76
8.4	EAE Enforcement.....	77
8.4.1	<i>CMTS and CM Behaviors when EAE is Enabled.....</i>	77
8.4.2	<i>EAE Enforcement Determination</i>	77
8.4.3	<i>EAE Enforcement of DHCP Traffic.....</i>	78
8.4.4	<i>CMTS and CM Behavior when EAE is Disabled.....</i>	78
8.4.5	<i>EAE Exclusion List</i>	78
8.4.6	<i>Interoperability Issues</i>	79
8.5	Authentication Reuse.....	79
8.6	BPI+ Control by Configuration File.....	79
8.6.1	<i>EAE Enabled.....</i>	79
8.6.2	<i>EAE Disabled.....</i>	79
9	SECURE PROVISIONING.....	81
9.1	Introduction	81
9.2	Encryption of Provisioning Messages	81
9.3	Securing DHCP	81
9.3.1	<i>Securing DHCP on the Cable Network Link</i>	81
9.3.2	<i>DHCPv6.....</i>	81
9.4	TFTP Configuration File Security	81
9.4.1	<i>Introduction</i>	81
9.4.2	<i>CMTS Security Features for Configuration File Download.....</i>	81
9.5	Securing REG-REQ-MP Messages	83
9.6	Source Address Verification.....	83
9.7	Address Resolution Security Considerations.....	84
10	USING CRYPTOGRAPHIC KEYS.....	86
10.1	CMTS	86
10.2	Cable Modem.....	88
10.3	Authentication of Dynamic Service Requests	89
10.3.1	<i>CM.....</i>	89
10.3.2	<i>CMTS.....</i>	89
11	CRYPTOGRAPHIC METHODS.....	90
11.1	Packet Data Encryption	90
11.2	Encryption of the TEK.....	91
11.3	HMAC-Digest Algorithm.....	91
11.4	TEKs, KEKs, and Message Authentication Keys.....	91
11.5	Public-Key Encryption of Authorization Key	92
11.6	Digital Signatures	92
11.7	The MMH-MIC	92
11.7.1	<i>The MMH Function</i>	92
11.7.2	<i>Definition of MMH-MAC.....</i>	95
11.7.3	<i>Calculating the DOCSIS MMH-MAC.....</i>	95
11.7.4	<i>MMH Key Derivation for CMTS Extended MIC.....</i>	97
11.7.5	<i>Shared Secret Recommendations.....</i>	97
11.7.6	<i>Key Generation Function.....</i>	97
12	PHYSICAL PROTECTION OF KEYS IN THE CM.....	99
13	BPI+ X.509 CERTIFICATE PROFILE AND MANAGEMENT.....	100
13.1	BPI+ Certificate Management Architecture Overview.....	100
13.2	Cable Modem Certificate Storage and Management in the CM	100
13.3	Certificate Processing and Management in the CMTS.....	101
13.3.1	<i>CMTS Certificate Management Model</i>	101
13.3.2	<i>Certificate Validation</i>	101

13.4 Certificate Revocation102

 13.4.1 Certificate Revocation Lists.....102

 13.4.2 Online Certificate Status Protocol.....103

14 SECURE SOFTWARE DOWNLOAD (SSD)105

 14.1 Introduction105

 14.2 Overview105

 14.3 Software Code Upgrade Requirements.....108

 14.3.1 Code File Processing Requirements.....108

 14.3.2 Code File Access Controls.....108

 14.3.3 Cable Modem Code Upgrade Initialization.....109

 14.3.4 Code Signing Guidelines111

 14.3.5 Code Verification Requirements.....111

 14.3.6 DOCSIS Interoperability113

 14.3.7 Error Codes113

 14.4 Security Considerations (Informative).....114

ANNEX A TFTP CONFIGURATION FILE EXTENSIONS (NORMATIVE).....116

 A.1 Encodings116

 A.1.1 Baseline Privacy Configuration Setting.....116

 A.2 Parameter Guidelines.....118

ANNEX B TFTP OPTIONS (NORMATIVE)119

ANNEX C DOCSIS 1.1/2.0 DYNAMIC SECURITY ASSOCIATIONS (NORMATIVE)127

 C.1 Introduction127

 C.2 Theory of Operation127

 C.3 SA Mapping State Model128

ANNEX D BPI/BPI+ INTEROPERABILITY (NORMATIVE)132

 D.1 DOCSIS BPI/BPI+ Interoperability Requirements.....132

 D.2 BPI 40-bit DES Export Mode Considerations133

 D.3 System Operation.....133

 D.3.1 CMTS with BPI Capability133

 D.3.2 CMTS with BPI+ Capability.....133

ANNEX E ADDITIONS AND MODIFICATIONS FOR CHINESE SPECIFICATION (NORMATIVE)135

 E.1 Security Requirement Differences for C-DOCSIS135

APPENDIX I EXAMPLE MESSAGES, CERTIFICATES, PDUS AND CODE FILE (INFORMATIVE)136

 I.1 Notation136

 I.2 Authentication Info136

 I.2.1 Device CA Certificate Details.....136

 I.3 Authorization Request139

 I.3.1 CM Device Certificate Details.....140

 I.4 Authorization Reply.....143

 I.4.1 Derivation of the Encryption Keys.....144

 I.4.2 Encryption of the Authorization Key.....144

 I.4.3 Hashing Details144

 I.5 Key Request.....146

 I.5.1 HMAC Digest Details147

 I.6 Key Reply148

 I.6.1 TEK Encryption Details.....149

 I.6.2 HMAC Details150

 I.7 Packet PDU Encryption (DES).....150

 I.7.1 CBC Only.....151

1.7.2	<i>CBC with Residual Block Processing</i>	152
1.7.3	<i>Runt Frame</i>	153
1.7.4	<i>40-bit Key</i>	154
1.8	Encryption of PDU with Payload Header Suppression (DES)	155
1.8.1	<i>Downstream</i>	155
1.8.2	<i>Upstream</i>	156
1.9	Fragmented Packet Encryption (DES)	157
1.10	Packet PDU Encryption (AES)	158
1.10.1	<i>CBC Only</i>	158
1.10.2	<i>CBC with Residual Block Processing</i>	159
1.10.3	<i>Runt Frame</i>	161
1.11	Encryption of PDU with Payload Header Suppression (AES)	161
1.11.1	<i>Downstream</i>	162
1.11.2	<i>Upstream</i>	163
1.12	Fragmented Packet Encryption (AES)	163
1.13	Secure Software Download CM Code File	165
APPENDIX II EXAMPLE OF MULTILINEAR MODULAR HASH (MMH) ALGORITHM IMPLEMENTATION (INFORMATIVE)		181
APPENDIX III CERTIFICATION AUTHORITY AND PROVISIONING GUIDELINES (INFORMATIVE)		191
III.1	Certificate Format and Extensions	191
III.2	CableLabs Root CA Certificate	192
III.3	CableLabs Device CACertificate	192
III.4	CM Device Certificate	193
III.5	CableLabs DOCSIS CVC CA Certificate	194
III.6	Code Verification Certificate	194
III.7	Certificate Installation	195
III.8	CM Code File Signing Policy and Format	195
III.8.1	<i>Manufacturer CM Code File Signing Policy</i>	195
III.8.2	<i>Operator CM Code File Signing Policy</i>	196
III.8.3	<i>CM Code File Format</i>	196
APPENDIX IV ACKNOWLEDGEMENTS (INFORMATIVE)		200
APPENDIX V REVISION HISTORY (INFORMATIVE)		201
V.1	Engineering Change for CM-SP-SECv3.1-I02-150326	201
V.2	Engineering Change for CM-SP-SECv3.1-I03-150611	201
V.3	Engineering Change for CM-SP-SECv3.1-I04-150910	201

Figures

Figure 1-1	- The DOCSIS Network	12
Figure 1-2	- Transparent IP Traffic Through the Data-Over-Cable System	13
Figure 1-3	- Data-over-Cable Reference Architecture	14
Figure 6-1	- Format of DOCSIS Variable-length PDU with Privacy EH Element	30
Figure 6-2	- Format of a DOCSIS MAC Fragmentation Frame with an Encrypted Payload	32
Figure 6-3	- Format of a DOCSIS MAC Management Message Frame with Encrypted Payload	34
Figure 7-1	- Relationship among Authorization and TEK State Machines	37
Figure 7-2	- Authorization State Machine Flow Diagram	41
Figure 7-3	- TEK State Machine Flow Diagram	49
Figure 8-1	- EAE Signaling Flow Chart for CM	76

Figure 10-1 - Authorization Key Management in CMTS and CM 87
 Figure 10-2 - TEK Management in CMTS and CM 88
 Figure 13-1 - CRL Framework 102
 Figure 13-2 - OCSP Framework 103
 Figure 14-1 - Typical Code Validation Hierarchy 107
 Figure C-1 - SA Mapping State Machine Flow Diagram 129
 Figure III-1 - Certificate PKI Hierarchy 191

Tables

Table 1-1 - DOCSIS 3.1 Series of Specifications 14
 Table 1-2 - DOCSIS 3.1 Related Specifications 14
 Table 6-1 - Summary of the Contents of Baseline Privacy Extended Headers 31
 Table 6-2 - Summary of the Contents of a DOCSIS Fragmentation MAC Frame's Baseline Privacy Extended Header 33
 Table 6-3 - Summary of the Contents of DOCSIS MAC Management Message Baseline Privacy Extended Headers 35
 Table 7-1 - Authorization FSM Transition Matrix 41
 Table 7-2 - TEK FSM State Transition Matrix 49
 Table 7-3 - Baseline Privacy Key Management MAC Messages 54
 Table 7-4 - Baseline Privacy Key Management Message Codes 54
 Table 7-5 - Authorization Request Attributes 56
 Table 7-6 - Authorization Reply Attributes 56
 Table 7-7 - Auth Reject Attributes 57
 Table 7-8 - Key Request Attributes 57
 Table 7-9 - Key Reply Attributes 57
 Table 7-10 - Key Reject Attributes 58
 Table 7-11 - Authorization Invalid Attributes 58
 Table 7-12 - TEK Invalid Attributes 59
 Table 7-13 - Authentication Information Attributes 59
 Table 7-14 - SA Map Request Attributes 59
 Table 7-15 - SA Map Reply Attributes 60
 Table 7-16 - SA MAP Reject Attributes 60
 Table 7-17 - BPKM Attribute Types 61
 Table 7-18 - Attribute Value Data Types 62
 Table 7-19 - TEK-Parameters Sub-Attributes 66
 Table 7-20 - Error-Code Attribute Code Values 67
 Table 7-21 - Security-Capabilities Sub-Attributes 69
 Table 7-22 - Data Encryption Algorithm Identifiers 69
 Table 7-23 - Data Authentication Algorithm Identifiers 69
 Table 7-24 - Cryptographic-Suite Attribute Values 69
 Table 7-25 - BPI-Version Attribute Values 70
 Table 7-26 - SA-Descriptor Sub-Attributes 71
 Table 7-27 - SA-Type Attribute Values 71

Table 7-28 - SA-Query Sub-Attributes.....	71
Table 7-29 - SA-Query-Type Attribute Values	72
Table A-1 - Recommended Operational Ranges for BPI Configuration Parameters.....	118
Table C-1 - Dynamic SAID State Transition Matrix	129
Table D-1 - BPI/BPI+ Interoperability Matrix.....	133
Table I-1 - New PKI Code File Example.....	165
Table I-2 - CVC Example	174
Table I-3 - CVC-CA Example	177
Table III-1 - CableLabs Root CA Certificate.....	192
Table III-2 - CableLabs Device CACertificate	192
Table III-3 - CM Device Certificate.....	193
Table III-4 - CableLabs DOCSIS CVC CA Certificate	194
Table III-5 - Code Verification Certificate	194
Table III-6 - CM Code File	197
Table III-7 - DOCSIS PKCS#7 Signed Data	197

This page has been left blank intentionally

1 SCOPE

1.1 Introduction and Purpose¹

This specification is part of the DOCSIS family of specifications developed by Cable Television Laboratories (CableLabs). In particular, this specification is part of a series of specifications that define the fifth generation of high-speed data-over-cable systems, commonly referred to as the DOCSIS 3.1 specifications. This specification was developed for the benefit of the cable industry, and includes contributions by operators and vendors from North and South America, Europe, and other regions.

1.2 Background

1.2.1 Broadband Access Network²

A coaxial-based broadband access network is assumed. This may take the form of either an all-coax or hybrid-fiber/coax network. The generic term "cable network" is used here to cover all cases.

A cable network uses a tree-and-branch architecture with analog transmission. The key functional characteristics assumed in this document are the following:

- Two-way transmission.
- A maximum optical/electrical spacing between the CMTS and the most distant CM of 50 miles in each direction, although typical maximum separation may be 15 miles.
- A maximum differential optical/electrical spacing between the CMTS and the closest and most distant modems of 50 miles (80 km) in each direction, although this would typically be limited to less than 15 miles (24 km).

At propagation velocity in fiber of approximately 1.5 ns/ft., 50 miles of fiber in each direction results in a round-trip delay of approximately 0.8 ms.

This is the maximum propagation delay assumed by this specification.

1.2.2 Network and System Architecture

1.2.2.1 The DOCSIS Network

The elements that participate in the provisioning of DOCSIS services are shown in Figure 1-1.

¹ Modified per SECv3.1-N-15.1342-1 on 8/25/15 by KB.

² Modified per SECv3.1-N-15.1342-1 on 8/25/15 by KB.

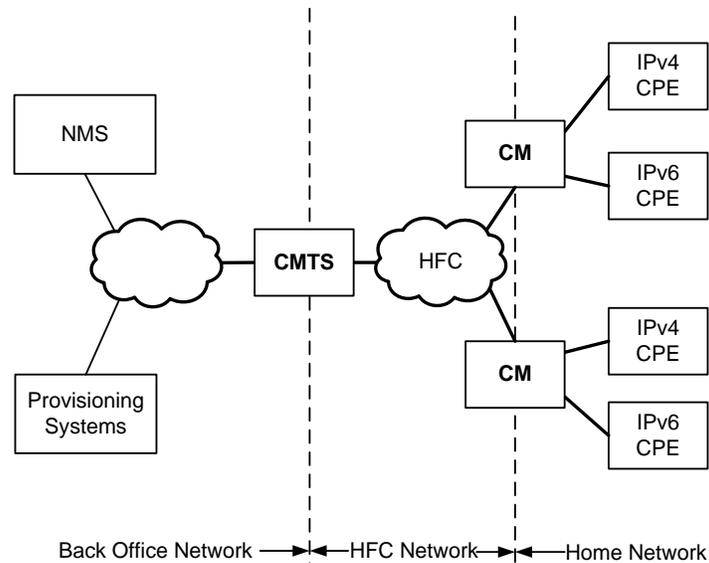

Figure 1-1 - The DOCSIS Network

The CM connects to the operator's cable network and to a home network, bridging packets between them. Many CPE devices can connect to the CM's LAN interfaces. CPE devices can be embedded with the CM in a single device, or they can be separate, standalone devices (as shown in Figure 1-1). CPE devices may use IPv4, IPv6, or both forms of IP addressing. Examples of typical CPE devices are home routers, set-top devices, personal computers, etc.

The CMTS connects the operator's back office and core network with the cable network. Its main function is to forward packets between these two domains, and between upstream and downstream channels on the cable network.

Various applications are used in the back office to provide configuration and other support to the devices on the DOCSIS network. These applications use IPv4 and/or IPv6, as appropriate to the particular operator's deployment. Applications include:

Provisioning Systems

- The DHCP servers provide the CM with initial configuration information, including IP address(es), when the CM boots.
- The Config File server is used to download configuration files to CMs when they boot. Configuration files are in binary format and permit the configuration of the CM's parameters.
- The Software Download server is used to download software upgrades to the CM.
- The Time Protocol server provides Time Protocol clients, typically CMs, with the current time of day.
- Certificate Revocation server provides certificate status.

Network Management System (NMS)

- The SNMP Manager allows the operator to configure and monitor SNMP Agents, typically the CM and the CMTS.
- The Syslog server collects messages pertaining to the operation of devices.
- The IPDR Collector server allows the operator to collect bulk statistics in an efficient manner.

1.2.3 Service Goals

As cable operators have widely deployed high-speed data services on cable television systems, the demand for bandwidth has increased. Additionally, networks have scaled to such a degree that IPv4 address space limitations have become a constraint on network operations. To this end, CableLabs' member companies have decided to add new features to the DOCSIS specification for the purpose of increasing channel capacity, enhancing network security, expanding addressability of network elements, and deploying new service offerings.

The DOCSIS system allows transparent bi-directional transfer of Internet Protocol (IP) traffic, between the cable system head-end and customer locations, over an all-coaxial or hybrid-fiber/coax (HFC) cable network. This is shown in simplified form in Figure 1-2.

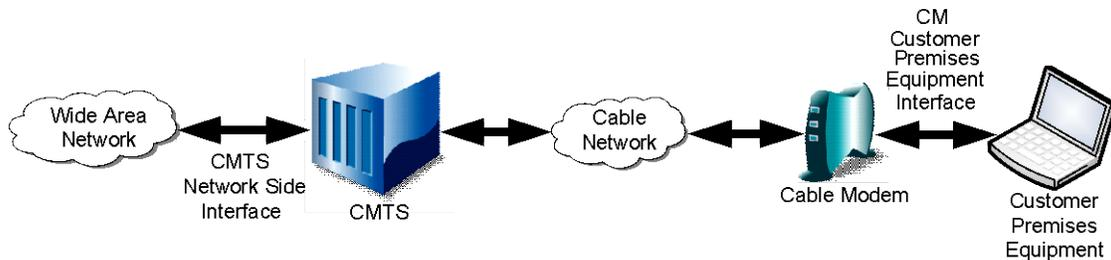

Figure 1-2 - Transparent IP Traffic Through the Data-Over-Cable System

1.2.4 Statement of Compatibility

This specification defines the DOCSIS 3.1 interface. Prior generations of DOCSIS were commonly referred to as DOCSIS 1.0, 1.1, 2.0 and 3.0. DOCSIS 3.1 is backward-compatible with equipment built to the previous specifications with the optional exception for handling DOCSIS 1.0 CMs. DOCSIS 3.1-compliant CMs interoperate seamlessly with DOCSIS 3.0, DOCSIS 2.0, DOCSIS 1.1, and may optionally support DOCSIS 1.0 CMTSs. DOCSIS 3.1-compliant CMTSs seamlessly support DOCSIS 3.0, DOCSIS 2.0, DOCSIS 1.1, and DOCSIS 1.0 CMs. Refer to Annex G of [DOCSIS MULPIv3.1] for general DOCSIS interoperability requirements.

Refer to Annex D for BPI/BPI+ compatibility requirements.

1.2.5 Reference Architecture

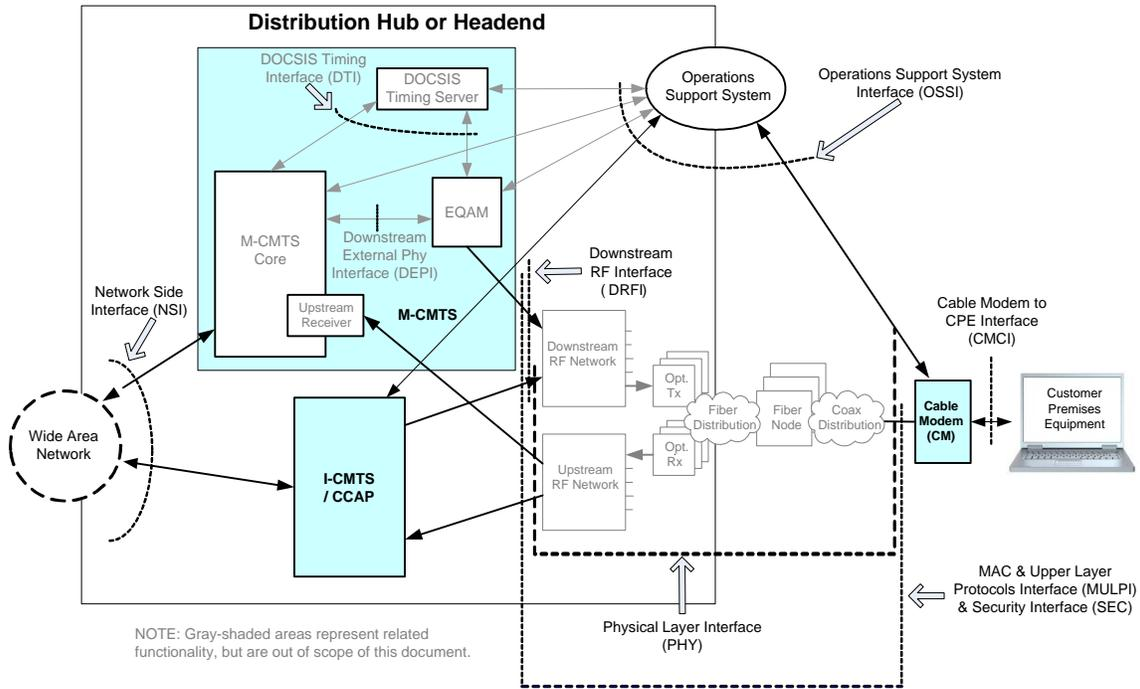

Figure 1-3 - Data-over-Cable Reference Architecture

The reference architecture for data-over-cable services and interfaces is shown in Figure 1-3. The lighter shaded areas are related functionality, but are out of the scope of DOCSIS specifications. Boxes represent functional components and arrows represent interfaces.

1.2.6 DOCSIS 3.1 Documents

A list of the specifications in the DOCSIS 3.1 series is provided in Table 1-1. For further information, please refer to <http://www.cablemodem.com>.

Table 1-1 - DOCSIS 3.1 Series of Specifications

Designation	Title
CM-SP-PHYv3.1	Physical Layer Specification
CM-SP-MULPIv3.1	Media Access Control and Upper Layer Protocols Interface Specification
CM-SP-CM-OSSv3.1	Cable Modem Operations Support System Interface Specification
CM-SP-CCAP-OSSv3.1	Converged Cable Access Platform Operations Support System Interface Specification
CM-SP-SECv3.1	Security Specification
CM-SP-CMCIv3.0	Cable Modem CPE Interface Specification

This specification defines security requirements.

Related DOCSIS specifications are listed in Table 1-2.

Table 1-2 - DOCSIS 3.1 Related Specifications

Designation	Title
CM-SP-eDOCSIS	eDOCSIS™ Specification
CM-SP-DRFI	Downstream Radio Frequency Interface Specification

CM-SP-DTI	DOCSIS Timing Interface Specification
CM-SP-DEPI	Downstream External PHY Interface Specification
CM-SP-DSG	DOCSIS Set-Top Gateway Interface Specification
CM-SP-ERMI	Edge Resource Manager Interface Specification
CM-SP-M-OSSI	M-CMTS Operations Support System Interface Specification
CM-SP-L2VPN	Layer 2 Virtual Private Networks Specification
CM-SP-TEI	TDM Emulation Interfaces Specification

1.3 Requirements

Throughout this document, the words that are used to define the significance of particular requirements are capitalized. These words are:

"MUST"	This word means that the item is an absolute requirement of this specification.
"MUST NOT"	This phrase means that the item is an absolute prohibition of this specification.
"SHOULD"	This word means that there may exist valid reasons in particular circumstances to ignore this item, but the full implications should be understood and the case carefully weighed before choosing a different course.
"SHOULD NOT"	This phrase means that there may exist valid reasons in particular circumstances when the listed behavior is acceptable or even useful, but the full implications should be understood and the case carefully weighed before implementing any behavior described with this label.
"MAY"	This word or the adjective "OPTIONAL" means that this item is truly optional. One vendor may choose to include the item because a particular marketplace requires it or because it enhances the product, for example; another vendor may omit the same item.

This document defines many features and parameters, and a valid range for each parameter is usually specified. Equipment (CM and CMTS) requirements are always explicitly stated. Equipment is to comply with all mandatory (MUST and MUST NOT) requirements to be considered compliant with this specification. Support of non-mandatory features and parameter values is optional.

1.4 Conventions

In this specification the following convention applies any time a bit field is displayed in a figure. The bit field should be interpreted by reading the figure from left to right, then from top to bottom, with the MSB being the first bit so read and the LSB being the last bit so read.

MIB syntax and XML Schema syntax is represented by this code sample font.

NOTE: Notices and/or Warnings are identified by this style font and label.

2 REFERENCES

2.1 Normative References

In order to claim compliance with this specification, it is necessary to conform to the following standards and other works as indicated, in addition to the other requirements of this specification. Intellectual property rights may be required to implement these references.

- [CCAP-OSSIV3.1] DOCSIS 3.1 CCAP OSSI Specification, CM-SP-CCAP-OSSIV3.1-I05-150910, September 10, 2015, Cable Television Laboratories, Inc.
- [C-DOCSIS] Data-Over-Cable Interface Specifications, C-DOCSIS System Specification, CM-SP-CDOCSIS-I02-150305, March 5, 2015, Cable Television Laboratories, Inc.
- [DOCSIS BPI+] Data-Over-Cable Service Interface Specifications, Baseline Privacy Interface Specification, CM-SP-BPI+-C01-081104, November 4, 2008, Cable Television Laboratories, Inc.
- [DOCSIS CM-OSSIV3.1] DOCSIS 3.1 Cable Modem OSSI Specification, CM-SP-CM-OSSIV3.1-I05-150910, September 10, 2015, Cable Television Laboratories, Inc.
- [DOCSIS MULPIV3.1] DOCSIS 3.1 MAC and Upper Layer Protocols Interface Specification, CM-SP-MULPIV3.1-I07-150910, September 10, 2015, Cable Television Laboratories, Inc.
- [DOCSIS RFIv2.0] Data-Over-Cable Service Interface Specifications, Radio Frequency Interface Specification, CM-SP-RFIv2.0-C02-090422, April 22, 2009, Cable Television Laboratories, Inc.
- [DOCSIS SECv3.0] Data-Over-Cable Service Interface Specifications, DOCSIS 3.0, Security Specification, CM-SP-SECv3.0-I15-130808, August 8, 2013, Cable Television Laboratories, Inc.
- [FIPS 140-2] Federal Information Processing Standards Publication (FIPS PUB) 140-2, Security Requirements for Cryptographic Modules, June 2001.
- [FIPS 180-4] Federal Information Processing Standards Publication (FIPS PUB) 180-2, Secure Hash Standard, May 2014.
- [FIPS 197] Federal Information Processing Standards Publication (FIPS PUB) 197, Advanced Encryption Standard, November, 2001.
- [FIPS 46-3] Federal Information Processing Standards Publication (FIPS PUB) 46-3, Data Encryption Standard, October 1999.
- [ISO 8859-1] ISO/IEC 8859-1:1998, 8-bit single-byte coded graphic character sets -- Part 1: Latin alphabet No.1.
- [MMH] S. Halevi and H. Krawczyk, MMH: Software Message Authentication in Gbit/sec Rates, Proceedings of the 4th Workshop on Fast Software Encryption, (1997) vol. 1267 Springer-Verlag, pp. 172-189.
- [NIST-800-38A] NIST-800-38A, Recommendation for Block Cipher Modes of Operation, Methods and Techniques, Morris Dworkin, 2001 Edition.
- [PKCS#7] RSA Laboratories, PKCS #7: Cryptographic Message Syntax Standard, An RSA Laboratories Technical Note, Version 1.5, Revised November 1, 1993.
- [PKT-SEC] PacketCable™ Security Specification, PKT-SP-SEC-C01-071129, November 29, 2007, Cable Television Laboratories, Inc.

- [RFC 826] IETF RFC 826/STD0037, D.C. Plummer, Ethernet Address Resolution Protocol: Or converting network protocol addresses to 48.bit Ethernet address for transmission on Ethernet hardware, November 1, 1982.
- [RFC 1350] IETF RFC 1350/STD0033, K. Sollins, The TFTP Protocol, Revision 2, July 1992.
- [RFC 2104] IETF RFC 2104, HMAC: Keyed-Hashing for Message Authentication, H. Krawczyk et al., February, 1997.
- [RFC 2347] IETF RFC 2347, G. Malkin, A. Harkin; TFTP Option Extension, May 1998.
- [RFC 2348] IETF RFC 2348, G. Malkin, A. Harkin; TFTP Blocksize Option, May 1998.
- [RFC 2349] IETF RFC 2349, G. Malkin, A. Harkin; TFTP Timeout Interval and Transfer Size Options, May 1998.
- [RFC 2616] IETF RFC 2616, R. Fielding, et al., Hypertext Transfer Protocol -- HTTP/1.1, June 1999
- [RFC 3376] IETF RFC 3376 B. Cain, et al. Internet Group Management Protocol, Version 3, October 2002.
- [RFC 4131] IETF RFC 4131, S. Green et al., Management Information Base for Data Over Cable Service Interface Specification (DOCSIS) Cable Modems and Cable Modem Termination Systems for Baseline Privacy Plus, September, 2005.
- [RFC 4861] IETF RFC 4861 Neighbor Discovery for IP version 6 (IPv6). T. Narten, E. Nordmark, W. Simpson, H. Soliman, September 2007
- [RFC 5280] IETF RFC 5280, D. Cooper, S. Santesson, S. Farrell, S. Boeyen, R. Housley, W. Polk, Internet X.509 Public Key Infrastructure Certificate and Certificate Revocation List (CRL) Profile, May 2008.
- [RFC 6960] IETF RFC 6960, X.509 Internet Public Key Infrastructure Online Certificate Status Protocol - OCSP. S. Santesson, M. Myers, R. Ankney, A. Malpani, S. Galperin, C. Adams, June 2013
- [RSA1] RSA Laboratories, PKCS #1: RSA Encryption Standard. Version 1.5, RSA Security, Inc., Bedford, MA, November 1993.
- [RSA3] RSA Laboratories, PKCS #1 v2.0: RSA Cryptography Standard, October 1, 1999.
- [SCTE 22-2] ANSI/SCTE 22-2 2012, DOCSIS 1.0 Baseline Privacy Interface.
- [SCTE 52] ANSI/SCTE 52 2013, Data Encryption Standard Cipher Block Chaining Pocket Encryption.
- [X.509] ITU-T Recommendation X.509 (10/12): Information Technology - Open Systems Interconnection - The Directory: Authentication Framework 2008.
- [X.690] ITU-T Recommendation X.690 (11/08) | ISO/IEC 8825-1:2002, Information Technology - ASN.1 Encoding Rules: Specification of Basic Encoding Rules (BER), Canonical Encoding Rules (CER) and Distinguished Encoding Rules (DER).

2.2 Informative References

This specification uses the following informative references.

- [DOCSIS CMCIv3.0] Data-Over-Cable Service Interface Specifications Cable Modem to Customer Premise Equipment Interface Specification CM-SP-CMCIv3.0-I02-140729, July 29, 2014, Cable Television Laboratories, Inc.
- [ISO 3166] ISO 3166-1, Codes for the representation of names of countries and their subdivisions -- Part 1: Country codes.
- [RFC 2202] IETF RFC 2202, P. Cheng, R. Glenn, Test cases for HMAC-MD5 and HMAC-SHA-1, September 1997.
- [RFC 3550] IETF RFC 3550/STD0064, H. Schulzrinne, S. Casner, R. Frederick, V. Jacobson, RTP: A Transport Protocol for Real-Time Applications, July 2003.
- [RFC 4086] IETF RFC 4086, D. Eastlake, J. Schiller, S. Crocker, Randomness Requirements for Security, June 2005.
- [RSA2] RSA Laboratories, Some Examples of the PKCS Standards, RSA Data Security, Inc., Bedford, MA, November 1, 1993.
- [SET Book 2] SET, Secure Electronic Transaction Specification Book 2: Programmer's Guide, Version 1.0, May 31, 1997.

2.3 Reference Acquisition

- Cable Television Laboratories, Inc., 858 Coal Creek Circle, Louisville, CO 80027; Phone +1-303-661-9100; Fax +1-303-661-9199. <http://www.cablemodem.com>.
- Federal Information Processing Standards: 100 Bureau Drive, Mail Stop 3200, Gaithersburg, MD 20899-3200. Phone +1-301-975-4054; Fax +1-301-926-8091. <http://csrc.nist.gov/publications/fips/>.
- IETF Secretariat, c/o Corporation for National Research Initiatives, 1895 Preston White Drive, Suite 100, Reston, VA 20191-5434 Phone +1-703-620-8990; Fax +1-703-620-9071. <http://www.ietf.org>.
- ITU Recommendations: Place des Nations, CH-1211, Geneva 20, Switzerland. Phone +41-22-730-51-11; Fax +41-22-733-7256. <http://www.itu.int>.
- Public Key Cryptography Standards: RSA Security Inc. 174 Middlesex Turnpike, Bedford, MA 01730. Phone +1-781-515-5000; Fax 781-515-5010. <http://www.rsasecurity.com/rsalabs/>.
- SCTE, Society of Cable Telecommunications Engineers, 140 Philips Road, Exton, PA 19341-1318, Phone +1-800-542-5040; Fax+1-610-363-5898, <http://www.scte.org/default.aspx/>.

3 TERMS AND DEFINITIONS

This specification uses the following terms:

Bridging CMTS	A CMTS that makes traffic forwarding decisions between its Network System Interfaces and MAC Domain Interfaces based upon the Layer 2 Ethernet MAC address of a data frame.
DER Encoded	A value which is encoded using the ASN.1 Distinguished Encoding Rules [X.690].
Downstream	Flow of signals from the cable system control center through the distribution network to the customer. For communication purposes, associated with transmission (down) to the end-user.
Dynamically-joined Multicast Sessions	Multicast sessions joined after cable modem registration.
Key transition period	The time period in which an Authentication Key that is near its expiration is replaced by a new Authentication Key through a negotiated update process between the CMTS and the CM.
Legacy PKI	The legacy PKI is defined by the DOCSIS 3.0 Security specification [DOCSIS SECv3.0] and supports backward compatibility with devices implementing older versions of DOCSIS Security; the term legacy can refer to aspects of the legacy PKI such as legacy certificates and legacy keys.
MAC domain	A logical link layer network consisting of a common address scheme (such as IEEE 802.3 Ethernet) in which elements may send and receive OSI layer 2 messages between and among one another. MAC domain boundaries may be established through both physical and logical means; separate channels or subchannels utilizing differing frequency and/or encoding methods, or assigning separate bundles/bridge groups or subinterfaces to common frequency-domain channels or subchannels.
Routing CMTS	A CMTS that makes traffic forwarding decisions between its Network System Interfaces and MAC Domain Interfaces based upon the Layer 3 (network) address of a packet.
Static Multicast Sessions	Multicast sessions joined during cable modem registration.
Trust anchor	An authoritative entity for which trust is assumed and not derived. In DOCSIS 3.1, the root certificate acts as the trust anchor from which the chain of trust is derived.
Upstream	Traffic and paths that go from the subscriber to the headend.

4 ABBREVIATIONS AND ACRONYMS

This specification uses the following abbreviations and acronyms:

3DES	Triple encryption with the Data Encryption Standard
AES	Advanced Encryption Standard
AK	Authorization Key
ARP	Address Resolution Protocol
ASN.1	Abstract Syntax Notation 1
BCP	Best Current Practice
BPI+	Baseline Privacy Interface Plus
BPKM	Baseline Privacy Key Management
CA	Certificate Authority
CBC	Cipher Block Chaining
CFB	Cipher Feedback
CM	Cable Modem
CMCI	Cable Modem to Customer Premises Equipment Interface
CMTS	Cable Modem Termination System
CPE	Consumer Premises Equipment
CRC	Cyclic Redundancy Check
CRL	Certificate Revocation List
CTR	Counter: the counter mode of a block cipher
CVC	Code Verification Certificate
CVS	Code Verification Signature
DA	Destination Address
DER	Distinguished Encoding Rules
DES	Data Encryption Standard
DHCP	Dynamic Host Configuration Protocol
DHCPv4	Version of DHCP for IPv4
DHCPv6	Version of DHCP for IPv6
DOCSIS	Data-Over-Cable Service Interface Specifications
DoS	Denial of Service
DSID	Downstream Service Identifier
EAE	Early Authentication and Encryption
ECB	Electronic Code Book
EDE	Encrypt-Decrypt-Encrypt
EH	Extended Header
EHDR	Extended MAC Header
Fn	The nth Fermat number
FC	Frame Control
FCRC	Fragment Cyclic Redundancy Check
FIPS	Federal Information Processing Standards

FSM	Finite State Machine
HCS	Header Check Sequence
HFC	Hybrid Fiber/Coax
HMAC	Keyed-Hash Message Authentication Code
IEEE	Institute of Electrical and Electronics Engineers
IGMP	Internet Group Management Protocol
IP	Internet Protocol
IPR	Intellectual Property Rights
IPv4	Version 4 of the Internet Protocol
IPv6	Version 6 of the Internet Protocol
ISO	International Organization for Standards
ITU-T	Telecommunication Standardization Sector of the International Telecommunications Union
IV	Initialization Vector
KEK	Key Encryption Key
LAN	Local Area Network
LSB	Least Significant Bit
MAC	Media Access Control
MDD	MAC Domain Descriptor
MGF	Mask Generation Function
MIB	Management Information Base
MIC	Message Integrity Check
MLD	Multicast Listener Discovery
MMH	Multilinear Modular Hash
MSB	Most Significant Bit
MSO	Multiple Systems Operator
NMS	Network Management System
OCSP	Online Certificate Status Protocol
OID	Object Identifier
OSS	Operations Support System
OUI	Organizationally Unique Identifier
PDU	Protocol Data Unit
PHS	Payload Header Suppression
PKI	Public Key Infrastructure
QoS	Quality of Service
RF	Radio Frequency
RFC	Request For Comments
RSA	Rivest, Shamir, Adleman (a public key cryptographic algorithm)
RTP	Real-time Transport Protocol
SA	Security Association
SA	Source Address
SAID	Security Association Identifier

SAV	Source Address Verification
SET	Secure Electronic Transaction
SHA-1	Secure Hash Algorithm 1
SID	Service Identifier
SNMP	Simple Network Management Protocol
SSD	Secure Software Download
TEK	Traffic Encryption Key
TFTP	Trivial File Transfer Protocol
TLV	Type/Length/Value
ToD	Time of Day
UTC	Coordinated Universal Time
XOR	Exclusive Or

5 OVERVIEW

The intent of this specification is to describe security services for DOCSIS communications. It has two main goals:

1. To provide cable modem (CM) users with data privacy across the cable network;
2. To prevent unauthorized users from gaining access to the network's RF MAC services.

This specification provides operators with tools to secure the provisioning process of Cable Modems (CM) and protect Cable Modem users by encrypting traffic flows between the CM and the Cable Modem Termination System (CMTS).

The protected RF MAC data communications services fall into three categories:

1. Best-effort high-speed IP data services;
2. Data services with guaranteed QoS;
3. IP multicast group services.

The CMTS protects against unauthorized access to these data transport services by enforcing encryption of the associated traffic flows across the cable network. DOCSIS employs an authenticated client/server key management protocol in which the CMTS (the server) controls distribution of keying material to CMs (the clients).

The system defined by this specification is used to protect packets on the cable network and is based on DOCSIS Baseline Privacy Plus [DOCSIS BPI+], which in turn was based on the original DOCSIS Baseline Privacy scheme [SCTE 22-2].

This specification explicitly assumes the following to be true:

- It is acceptable that DOCSIS 3.1 security features are designed to provide a reasonable level of security for a 10 year time frame.
- The operational life of a CM will not exceed 20 years.
- The interface between the CMTS and provisioning servers is secure.
- CM provisioning servers are trusted.
- At the beginning of the provisioning process, the CM is not trusted. The CM increases its level of trust as it successfully completes different provisioning steps. These steps include device authentication, registration request validation, and service authorization. Once the CM successfully completes the provisioning process with DOCSIS 3.1 security features enabled, it is considered trusted enough to provide data services to subscribers.
- Threat to integrity of encrypted data on the cable network link is low.
- To be backward compatible with existing devices, it is acceptable to continue the support of features that are considered to have low level security characteristics. MSOs can enable/disable these features as needed.

5.1 New DOCSIS 3.1 Security Features

DOCSIS 3.1 defines a new certificate public key infrastructure (PKI) that strengthens the security of CM authentication and secures software download features.

This specification defines the Base Line Privacy Plus (BPI+) architecture which covers CM authentication, key exchange, and establishing encrypted traffic sessions between the CM and CMTS. Early Authentication and Encryption (EAE) applies BPI+, earlier in the provisioning process (see Section 8). This specification also defines security features for the CM provisioning process, which includes Secure Software Download (SSD).

5.1.1 BPI+ Architecture

BPI+ has two component protocols:

- An encapsulation protocol for encrypting packet data across the cable network. This protocol defines:
 1. The frame format for carrying encrypted packet data within DOCSIS MAC frames;
 2. A set of supported cryptographic suites, i.e., pairings of data encryption and authentication algorithms;
 3. The rules for applying those algorithms to a DOCSIS MAC frame's packet data.
- A key management protocol (Baseline Privacy Key Management, BPKM) to provide secure distribution of keying data from CMTSs to CMs. Through BPKM, the CM and CMTS synchronize keying data; in addition, the CMTS uses the protocol to implement conditional access to network services.

5.1.1.1 Packet Data Encryption

DOCSIS encryption services are defined as a set of extended services within the DOCSIS MAC sublayer. Packet Header information specific to security is placed in a Baseline Privacy Extended Header element within the MAC Extended Header (see [DOCSIS MULPIv3.1]).

DOCSIS encrypts only the MAC Frame's packet data; the header of the DOCSIS MAC Frame is never encrypted. DOCSIS MAC management messages, except REG-REQ-MP messages, are always unencrypted. REG-REQ-MP messages are encrypted when EAE is enabled. Section 6 specifies the format of DOCSIS MAC Frames carrying encrypted packet data payloads.

5.1.1.2 Key Management Protocol

CMs use the Baseline Privacy Key Management (BPKM) protocol (see Section 7) to obtain authorization and traffic encryption keying material from the CMTS, and to support periodic reauthorization and key refresh. The BPKM protocol uses digital certificates, a public-key encryption algorithm, and two-key 3DES to secure key exchanges between the CM and the CMTS.

The BPKM protocol adheres to a client/server model, where the CM, a BPKM client, requests keying material, and the CMTS, a BPKM server, responds to those requests, ensuring that individual CM clients receive only keying material for which they are authorized. The BPKM protocol is transported over DOCSIS MAC management messages.

DOCSIS uses public-key cryptography to establish a shared secret (an Authorization Key) between the CM and its CMTS. The shared secret is then used to derive secondary keys which are in turn used to secure subsequent BPKM exchanges of traffic encryption keys. This two-tiered mechanism for key distribution permits traffic encryption keys to be updated without incurring the overhead of computationally-intensive public-key operations.

A CMTS authenticates a client CM during the initial authorization exchange, which occurs when Early Authentication and Encryption (EAE) is enabled, or when post registration BPI+ is enabled (see Section 8). Each CM carries a unique digital certificate issued by the CM's manufacturer. The digital certificate contains the CM's public key, along with the CM MAC address, the identity of the manufacturer, and the CM serial number. When requesting an Authorization Key, a CM presents its digital certificate to a CMTS. The CMTS verifies the digital certificate, then uses the CM's public key to encrypt an Authorization Key, which the CMTS sends to the requesting CM.

5.1.1.3 DOCSIS Security Associations

A DOCSIS Security Association (SA) is the set of security information a CMTS, and one or more of its client CMs share, in order to support secure communications across the cable network.

There are three types of DOCSIS Security Associations: Primary, Static, and Dynamic. A Primary Security Association is tied to a single CM, and is established when that CM completes authentication. Static Security Associations can be shared by multiple CMs and are established, based on a CMTS configuration, when a CM completes authentication. Dynamic Security Associations can be shared by multiple CMs and are normally established dynamically, in response to the request of initiation of specific downstream traffic flows.

- A Security Association's shared information comprises the cryptographic suite, traffic encryption keys and CBC initialization vectors, and the lifetime of the keying information. Each Security Association is identified with a 14-bit handle, known as a Security Association Identifier (SAID).
- Each CM on which security is enabled establishes a Primary SA with its CMTS. When the CM encrypts upstream traffic, including the REG-REQ-MP MAC management message, it **MUST** use the CM's Primary SA. The value of the Primary SAID is established during the initial authorization exchange.
- Downstream traffic may be encrypted under any of the three types of SAs. A downstream IP multicast data packet, for example, is typically intended for multiple CMs, and hence, is usually encrypted under a Static or Dynamic SA. Downstream unicast traffic directed at CPE devices behind the CM are typically encrypted under the CM's Primary SA.

A CM **MUST** support:

- A Primary SA;
- A minimum of 15 SAs each of which can be used as either a Dynamic SA or Static SA.

A CMTS **MUST** support:

- A Primary SA for every CM;
- At least one Dynamic SA (per CMTS).

A CMTS **MAY** support Static SAs.

Using the BPKM protocol, a CM requests from its CMTS and SA's keying material. The CMTS ensures that each client CM accesses only those Security Associations that it is entitled to access.

An SA's keying material (e.g., key and CBC Initialization Vector) has a limited lifetime. When the CMTS delivers SA keying material to a CM, it also provides the CM with that material's remaining lifetime. It is the responsibility of the CM to request new keying material before the current keying material expires. The BPKM protocol specifies how CM and CMTS maintain key synchronization.

5.1.1.4 QoS SIDs and DOCSIS SAIDs

The BPI+ Extended Header Element in downstream DOCSIS MAC frames (see [DOCSIS MULPIv3.1]) contains the DOCSIS SAID under which the downstream frame is encrypted. If the downstream frame is a unicast packet addressed to a CPE device behind a particular CM, the frame will typically be encrypted under the CM's Primary SA. If the downstream frame is a multicast packet intended for receipt by multiple CMs, the extended header element will contain the Static or Dynamic SAID mapped to that multicast group. The SAID (Primary, Static or Dynamic), in combination with other data fields in the downstream extended header element, identifies to a receiving modem, the particular set of keying material required to decrypt the DOCSIS MAC frame's encrypted Packet Data field. See Section 6 for details of the MAC frame format.

Because all upstream traffic is encrypted under the CM's Primary SA, upstream DOCSIS MAC frames do not carry a SAID in their extended headers; instead, the Baseline Privacy EH element may contain a valid QoS SID assigned to the CM (see Section 6.3 for details).

The Baseline Privacy Extended Header element serves multiple purposes in upstream DOCSIS PDU MAC frames. As an alternative to identifying the particular set of keying material used to encrypt a frame's packet data, certain Baseline Privacy Extended Header elements provide a mechanism for issuing piggybacked bandwidth requests (see Section 6.3.1); in some cases it can also carry fragmentation control data (see Section 6.4). These two functions are tied to a particular QoS SID; for this reason, the relevant upstream Baseline Privacy Extended Header Elements contain a QoS SID rather than a Primary SAID. The SAID can be deduced by the CMTS from the QoS SID and the logical upstream on which the MAC frame was received.

The SAID associated with a Primary, Static or Dynamic SA can be any 14-bit value. A CMTS **MUST NOT** assign the same SAID to more than one type of SA within a MAC Domain Downstream Service Group (MD-DS-SG). In other words, if a SAID is being used as a Primary SA, the CMTS cannot use the same SAID for a Static or Dynamic SA within the same MD-DS-SG. Likewise, if a CMTS has assigned a SAID to a Static or Dynamic SA,

that value cannot be used as the Primary SAID for any modem within that MD-DS-SG. Additionally, a CMTS MUST NOT assign the same SAID to more than one non-Primary (Static or Dynamic) SA within a MD-DS-SG.

5.1.1.5 BPI+ Enforce

BPI+ authentication includes digital certificate CM MAC address validation which helps prevent CM MAC address cloning and theft of service. Hackers could modify a CM's behavior in order to bypass BPI+ authentication and steal service using MAC address cloning. Enforcing BPI+ on the CMTS will help prevent this type of attack. The CMTS MUST support the following configurable BPI+ Enforce policies per-MAC domain:

Policy 0: Disable. The CMTS does not enforce BPI+.

Policy 1: 1.1 Style Config File Parameters and Capability. The CMTS enforces BPI+ on CMs that register with a DOCSIS 1.1 style configuration file with parameters indicating BPI+ is enabled (missing TLV 29 or containing TLV 29 set to enable) and with a Modem Capabilities Privacy Support TLV (5.6) set to BPI+ support.

Policy 2: 1.1 Style Config File Parameters. The CMTS enforces BPI+ on CMs that register with a DOCSIS 1.1 style configuration file with parameters indicating BPI+ is enabled (missing TLV 29 or containing TLV 29 set to enable).

Policy 3: 1.1 Style Config File. The CMTS enforces BPI+ on CMs that register with a DOCSIS 1.1 style configuration file.

Policy 4: Total. The CMTS enforces BPI+ on all CMs.

Policies 1, 2, and 3 support a mixed network of DOCSIS 1.0 (including DSG) and DOCSIS 1.1 and higher CMs. Policy 4 is the most effective configuration for preventing CM MAC address cloning, but it blocks DOCSIS 1.0 CMs since they do not support BPI+. Therefore, if Policy 4 is used, authorized DOCSIS 1.0 CMs would need to be removed from the network or upgraded.

When a CMTS enforces BPI+ on a CM, it MUST NOT forward post-registration traffic in either direction for that CM until it has successfully established a Primary SA using EAE or post-registration BPI+ provisioning. BPI+ Enforce does not conflict with EAE. A DOCSIS 3.0 or higher CM that successfully performs EAE before registration will meet the BPI+ Enforce requirements that are applied after registration.

The CMTS MUST support the capability to exclude individual CMs (including DOCSIS 1.0 if the CMTS supports DOCSIS 1.0 CMs) from BPI+ Enforce based on their MAC addresses on a per-MAC domain basis. If a CM is on the exclusion list, the CMTS MUST NOT enforce BPI+ on that CM. This means the CMTS will support BPI+ if initiated by that CM, but it will not enforce it.

5.1.2 Secure Provisioning

The processes used to provision a CM are: DHCP, ToD, and TFTP at the IP layer; and registration at the MAC layer. Securing these provisioning processes play a critical role in protecting the CMs and the network from attacks, and in preventing service theft. The CMTS can help secure these processes by assuring that traffic is only forwarded to/from CMs and CPEs, with source IP addresses that have been assigned by the MSO. The CMTS can also verify that a CM is registering with the correct service parameters by learning CM provisioning information in DHCP and TFTP messaging flows.

Securing the CM software image download process helps assure that the CM is running the correct/authorized version of code. Authenticating the source and verifying the integrity of downloaded code is vital to the overall operation and security of DOCSIS-based networks. When properly triggered, the CM downloads a software image from a Software Download server and validates the new software image's digital signature before installation.

5.2 Operation

5.2.1 Cable Modem Initialization

The [DOCSIS MULPIv3.1] specification divides CM initialization into the following sequence of tasks:

- Scan for downstream channel and establish synchronization with the CMTS;

- Obtain transmit parameters;
- Perform ranging;
- Establish IP connectivity;
- Establish time of day;
- Transfer operational parameters (download configuration file);
- CMTS Registration.

BPI+ security may be established between the CM and the CMTS following CM ranging (Early Authentication and Encryption (EAE)), or following registration. Ordinarily, BPI+ is established using EAE immediately following ranging, and remains in effect at least until registration is complete. Parameters within the configuration file instruct the CM whether to maintain BPI+ security with the CMTS or to operate in an unsecured mode from that point onward. The CM runs with BPI+ security enabled, unless BPI+ is explicitly disabled in the DOCSIS configuration file.

BPI+ security initialization begins with the CM sending the CMTS an Authentication Information message containing the CM's Device CA Certificate (see Section 13) and an Authorization Request message. The Authorization Request contains the following information:

- Data identifying the CM (e.g., MAC address and other information unique to the device);
- The CM's RSA public key;
- A digital certificate to bind the CM's identifying data to the CM's public key;³
- A list of the cryptographic suites supported by the CM;
- The Initialization SAID (value 0).

If the CMTS successfully authenticates the requesting CM, it responds with an Authorization Reply containing the Primary SAID for the CM and an Authorization Key encrypted by the public key of the CM's certificate. The CM decrypts the encrypted Authorization Key using the private key of its certificate. From the Authorization Key, the CM and the CMTS derive the keys needed to secure a CM's subsequent requests for traffic encryption keys, and the CMTS's responses to these requests.

The Authorization Reply also contains a list of SA descriptors, which identify the Primary and Static SAs that the requesting CM is authorized to access. Each SA descriptor consists of a collection of SA parameters, including the SA's SAID, type and cryptographic suite. The list contains at least one entry: a descriptor describing the CM's primary SA. Additional entries are optional, and describe any Static SAs that the CM is permitted to access.

After successfully completing authentication and authorization with the CMTS, the CM sends key requests to the CMTS, requesting traffic encryption keys for each of the SA descriptors it received in the Authorization Reply. The CM's traffic key requests are authenticated using a keyed hash (the HMAC algorithm [RFC 2104]); the Message Authentication Key is derived from the Authorization Key, obtained during the authorization exchange. The CMTS responds to each key request with a Key Reply message containing Traffic Encryption Keys (TEKs); TEKs are 3DES encrypted, with a Key Encryption Key (KEK) derived from the Authorization Key. Like the Key Requests, Key Replies are authenticated with a keyed hash where the Message Authentication Key is derived from the Authorization Key.

BPI+ security Initialization ends when the CM has received the Key Reply messages associated with all the SAIDs identified in the Authorization Reply message, except those with cryptographic suites not supported by the CM.

5.2.1.1 Network Admission Control

Restricting network access to only authorized devices is an important part of maintaining security. One of the methods used to provide this function is CM authentication using [X.509] certificates. Certificates are issued to trusted vendor companies for installation in their CMs. When EAE or post registration BPI+ is enabled, each CM is

³ This means that the public key appears twice in the message, once as a standalone entity and once as part of the certificate.

authenticated by the CMTS, using these certificates before completing the provisioning process. If the CMTS is not able to validate the CM, it does not allow it to access the network.

Forcing all CMs to successfully complete EAE, or post registration BPI+ before allowing them access to the network can help prevent hackers from using older CMs to bypass authentication. This capability for EAE BPI+ is defined in this specification (see Section 8), and for post registration, BPI+ is defined in the [DOCSIS MULPIv3.1] specification.

5.2.1.2 EAE and Authentication Reuse

When EAE is enabled, CM authentication normally occurs following ranging completion, followed by key exchanges and encrypted session establishment (see Section 8). Because of this, the subsequent provisioning messages (DHCP, ToD, and TFTP) are secured between the CM and CMTS. This allows these provisioning applications to reuse the authentication and encryption functions of the CM for secure communication and avoids having to set up a separate secure session for each application, which would result in longer provisioning times and restrict other security features such as configuration file learning (see Section 9.4.2.4).

5.2.1.3 Configuration Registration Enforcement

To help prevent theft-of-service attacks caused by alterations to the configuration file, CMTS TFTP proxy requirements are specified herein. These requirements enable the CMTS to hide the true address of the TFTP server from the CM and other devices on the cable network and for them to learn the contents of the configuration file independently of the configuration information that is sent to it by the CM. When this feature is enabled, the CMTS proxies TFTP messages between the CM and TFTP server. The CM is provisioned with the CMTS IP address instead of the actual address of the configuration file server. This helps hide the TFTP server address from exposure on the cable network where it might be captured and used for a DoS attack.

The CMTS may also learn the contents of the configuration file as it relays DHCP messages and proxies the information between the configuration file server and the CM. With this information the CMTS can verify that the CM is downloading the correct configuration file and that the registration request contains the correct CM configuration settings.

5.2.2 Cable Modem Key Update Mechanism

The Traffic Encryption Keys (TEKs) that the CMTS provides to client CMs have limited lifetimes. The CMTS delivers a key's remaining lifetime, along with the key value, in the Key Reply messages that it sends to its client CMs. The CMTS controls which keys are current by flushing expired keys and generating new keys as required. It is the responsibility of individual CMs to ensure that the keys that they are using match those that the CMTS is using. CMs do this by tracking when a particular SAID's key is scheduled to expire and issuing a new Key Request prior to that time.

In addition, CMs are required to periodically reauthorize with the CMTS (see Section 7.1.4). As for TEKs, an Authorization Key has a finite lifetime that the CMTS provides to the CM along with the key value. It is the responsibility of each CM to reauthorize and obtain a fresh Authorization Key (and an up-to-date list of SA descriptors) before the CM's current Authorization Key expires. This intermediate period just before the expiration of the Authorization Key is called the key transition period.

5.2.3 Cable Modem Secure Software Download

To download a CM software image securely, the CM vendor and/or MSO will digitally sign the image using the appropriate code verification certificate (CVC) and place the image on a Software Download server. A CM is enabled to download a software image when it receives a valid CVC in its configuration file. Triggering the download of the software image can be done using parameters in the CM configuration file, or SNMP commands.

After a CM downloads a software image, it validates the image by verifying that the included CVC chains to the Root CA Certificate trust anchor, and by checking the image's digital signature. If this validation is successful, it installs the software image for operation.

6 ENCRYPTED DOCSIS MAC FRAME FORMATS

6.1 CM Requirements

When operating with BPI+ security enabled, the CM MUST encrypt the Protocol Data Unit (PDU) regions of all of the following types of DOCSIS MAC frames transmitted on to the cable network:

- Variable-length PDU MAC Frames;
- Fragmentation MAC Frames;
- Registration Request (REG-REQ-MP) MAC Management Message Frames.

In each of these cases, a Baseline Privacy Extended Header Element in the DOCSIS MAC Header identifies the Security Association and accompanying keying material that is used to encrypt the PDU. The CM MUST NOT encrypt (see Section 6.5) MAC Management messages, except REG-REQ-MP messages, unless they are part of a fragment.

6.2 CMTS Requirements

When communicating with a CM for which DOCSIS security is enabled, the CMTS MUST encrypt the Protocol Data Unit (PDU) regions of variable-length PDU MAC Frames and variable-length Isolation PDU MAC Frames [DOCSIS MULPIv3.1].

A Baseline Privacy Extended Header Element in the DOCSIS MAC Header identifies the Security Association and accompanying keying material that is used to encrypt the PDU. The CMTS MUST NOT encrypt (see Section 6.5) MAC Management messages.

6.3 Variable-Length PDU MAC Frame Format

Figure 6-1 depicts the format of a DOCSIS variable-length PDU MAC Frame or variable-length Isolation PDU MAC Frame, with a Privacy Extended Header (EH) Element and encrypted PDU payload.

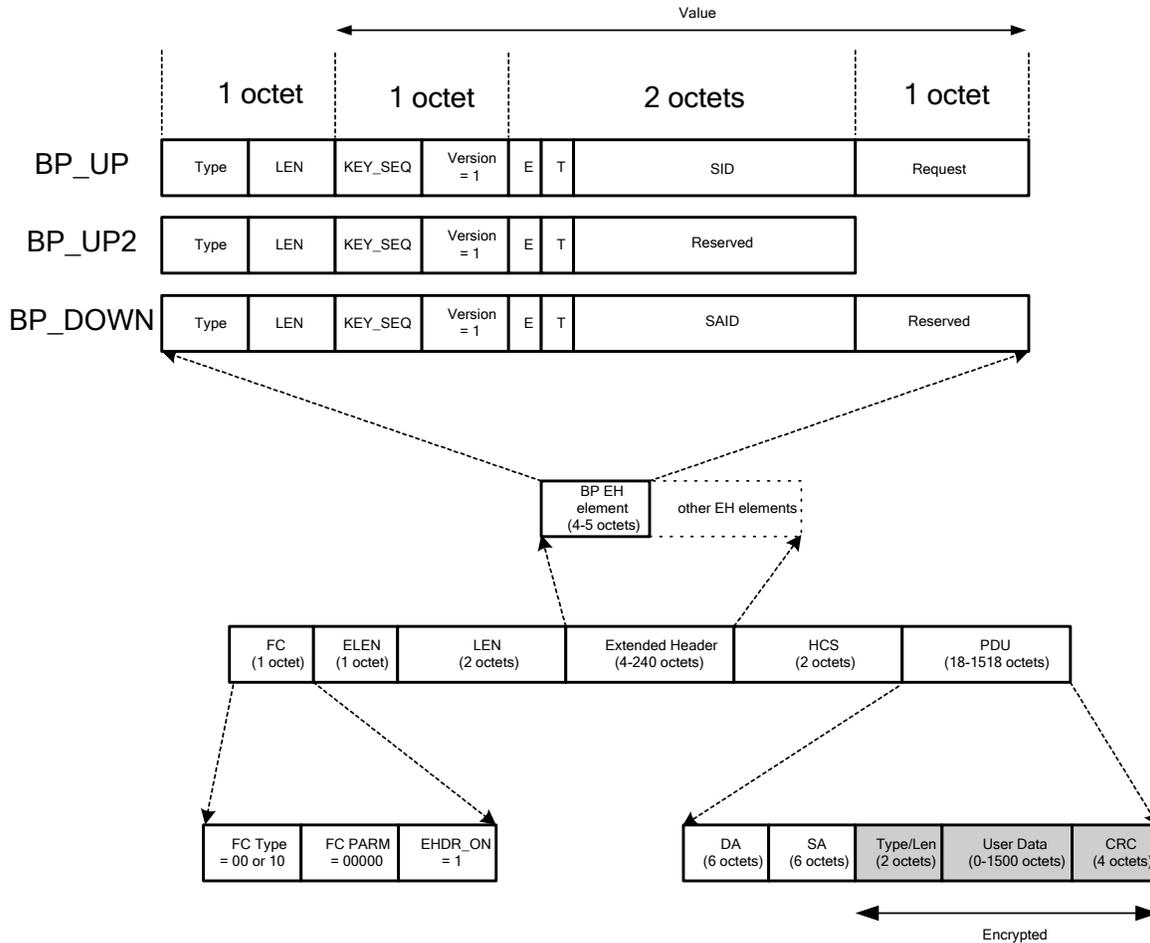

Figure 6-1 - Format of DOCSIS Variable-length PDU with Privacy EH Element

The CMTS MUST NOT encrypt the first twelve (12) octets of the PDU containing the Ethernet/802.3 destination and source addresses (DA/SA). The CM MUST NOT encrypt the first twelve (12) octets of the PDU containing the Ethernet/802.3 destination and source addresses (DA/SA). The CMTS MUST encrypt the PDU's Ethernet/802.3 CRC. The CM MUST encrypt the PDU's Ethernet/802.3 CRC .

The CM MUST include a Baseline Privacy Extended Header in all frames containing encrypted PDUs. The CM MUST make the Baseline Privacy Extended Header element the first Extended Header in an upstream frame. Upstream frames sent by the CM MUST contain the Type value BP_UP or BP_UP2 in the Baseline Privacy EH.

The CMTS MUST include a Baseline Privacy Extended Header in all frames containing encrypted PDUs. The Baseline Privacy Extended Header element MUST be the first Extended Header sent by the CMTS in a downstream frame. Downstream frames sent by the CMTS MUST contain the Type value BP_DOWN [DOCSIS MULPIv3.1] in the Baseline Privacy EH. The high-order bits of a Baseline Privacy Extended Header Value field contain a key sequence number, KEY_SEQ. The CMTS manages a key sequence number independently for each SAID and distributes this key sequence number along with the SAID's keying material to client CMs. For each SAID, the CMTS MUST increment KEY_SEQ by one each time that it generates new keying material for that SAID. The Baseline Privacy EH element includes this sequence number, along with the SAID, to identify the keying material that was used to encrypt the frame's PDU.

The four (4) bits following KEY_SEQ contain a protocol version number. The CMTS MUST set the protocol version number to the value one (1). The CM MUST set the protocol version number to the value one (1).

The next two octets contain two (2) bits of encryption status (ENABLE and TOGGLE) and the fourteen (14)-bit Reserved/SID/SAID (Reserved for upstream frames with the BP_UP2 EHDR, SID for upstream frames with the BP_UP EHDR, SAID for downstream frames).

The ENABLE encryption status bit indicates whether encryption is enabled for that PDU. If the PDU is unencrypted, the CMTS MUST set the ENABLE bit to zero (0). If the PDU is encrypted, the CM MUST set the ENABLE bit to zero (0). If the PDU is encrypted, the CMTS MUST set the ENABLE bit to one (1). If the PDU is encrypted, the CM MUST set the ENABLE bit to one (1).

The CMTS MUST make the TOGGLE bit match the value of the Least Significant Bit (LSB) of KEY_SEQ. The CM MUST make the TOGGLE bit match the value of the Least Significant Bit (LSB) of KEY_SEQ.

6.3.1 Baseline Privacy Extended Header Formats

The DOCSIS MAC protocol [DOCSIS MULPIv3.1] defines a Request EH element that is used to piggyback a bandwidth request on an upstream data transmission. The last octet of the upstream Baseline Privacy EH (BP_UP) carries an optional piggybacked bandwidth allocation request.

In downstream packets, the last octet is reserved [DOCSIS MULPIv3.1] and the CMTS MUST set its value to zero.

Table 6-1 - Summary of the Contents of Baseline Privacy Extended Headers

Type	Length	Value
BP_UP See [DOCSIS MULPIv3.1]	4	KEY_SEQ (4 bits), Version (4 bits), SID (2 octets), Request [piggyback] (1 octet) [CM → CMTS] KEY_SEQ field (4 bits): Key sequence number Version field (4 bits) is defined as: 0x1 SID field is defined as: Bit[15]: ENABLE: 1⇒Encryption enabled; 0⇒Encryption Disabled Bit[14]: TOGGLE: 1⇒Odd Key; 0⇒Even Key Bit[13:0]: Service ID. Request field contains the number of mini-slots requested for upstream bandwidth.
BP_UP2 See [DOCSIS MULPIv3.1]	3	KEY_SEQ (4 bits), Version (4 bits), ETR (2 octets) [CM → CMTS] KEY_SEQ field (4 bits): Key sequence number Version field (4 bits) is defined as: 0x1 ETR field is defined as: Bit[15]: ENABLE: 1⇒Encryption enabled; 0⇒Encryption Disabled Bit[14]: TOGGLE: 1⇒Odd Key; 0⇒Even Key Bit[13:0]: Reserved (set to 0)
BP_DOWN See [DOCSIS MULPIv3.1]	4	KEY_SEQ (4 bits), Version (4 bits), SAID (2 octets), Reserved (1 octet) [CMTS → CM] KEY_SEQ field (4 bits): Key sequence number Version field (4 bits) is defined as: 0x1 SAID field is defined as: Bit[15]: ENABLE: 1⇒Encryption enabled; 0⇒Encryption Disabled Bit[14]: TOGGLE: 1⇒Odd Key; 0⇒Even Key Bit[13:0]: Security Association ID. Reserved field is set to 0.

6.4 Fragmentation MAC Frame Format

In order to support fragmentation of upstream DOCSIS MAC frames, the Baseline Privacy EH element may carry both encryption and fragmentation control fields [DOCSIS MULPIv3.1]. When functioning in this role, the upstream Baseline Privacy Extended Header is extended by one octet, the additional octet serving as a fragmentation control field. Figure 6-2 depicts the format of a DOCSIS Fragmentation MAC Frame with an encrypted fragmentation payload.

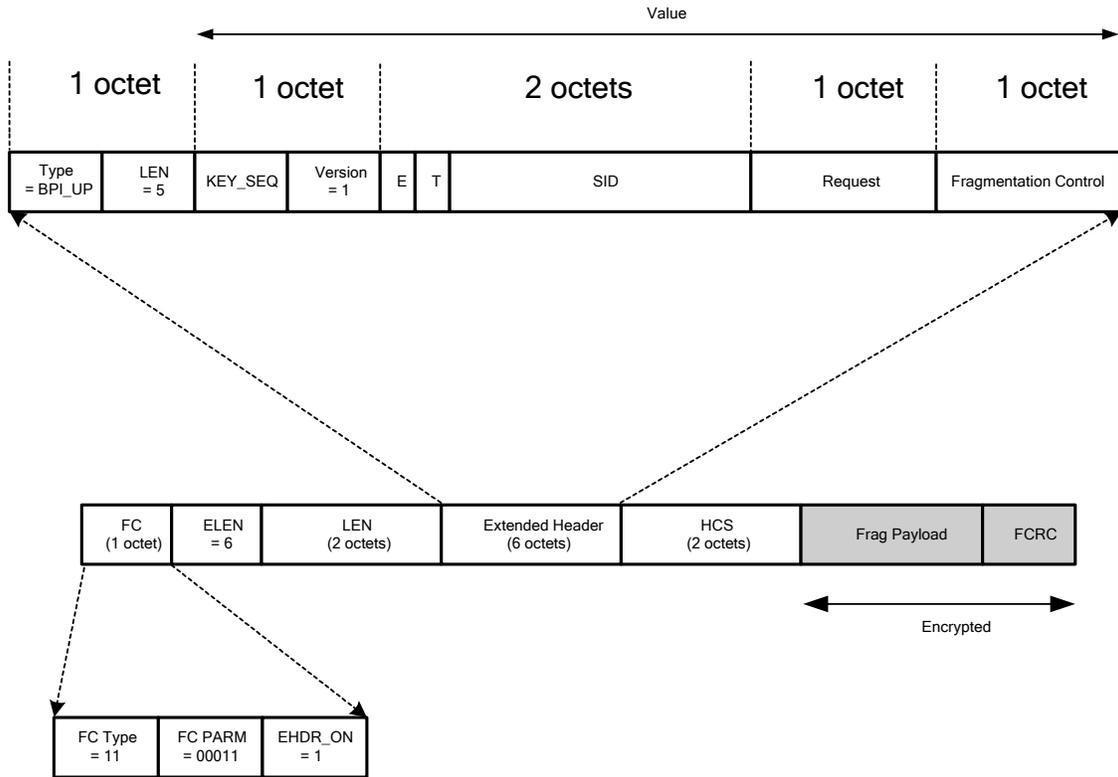

Figure 6-2 - Format of a DOCSIS MAC Fragmentation Frame with an Encrypted Payload

Frames with the frame control (FC) Type, set to 0b11 and FC PARM set to 0b00011, identify a DOCSIS MAC frame as a Fragmentation frame.⁴ The Fragmentation MAC header is followed by a Fragment Payload and a Fragment CRC. When encrypting a Fragmentation MAC frame, the CM MUST encrypt the Fragment Payload and the Fragment CRC (FCRC).

The LEN field of the Baseline Privacy EH element in Fragmentation MAC Frames is five (5), rather than four (4), accounting for the additional one (1)-octet fragmentation control field. The definitions and requirements for the KEY_SEQ field, VERSION field, ENABLE and TOGGLE flags, and SID field are unchanged from those for an upstream PDU MAC Frame.

⁴ Modified per SECv3.1-N-15.1342-1 on 8/25/15 by KB.

Table 6-2 - Summary of the Contents of a DOCSIS Fragmentation MAC Frame's Baseline Privacy Extended Header

TYPE	LENGTH	VALUE
BP_UP See [DOCSIS MULPIv3.1]	5	KEY_SEQ (4 bits), Version (4 bits), SID (2 octets), Request [piggyback] (1 octet), Fragmentation Control (1 octet) [CM → CMTS] KEY_SEQ field (4 bits): Key sequence number Version field (4 bits) is defined as: 0x1 SID field is defined as: Bit[15]: ENABLE: 1⇒Encryption enabled; 0⇒Encryption Disabled Bit[14]: TOGGLE: 1⇒Odd Key; 0⇒Even Key Bit[13:0]: Service ID. Request field contains the number of mini-slots requested for upstream bandwidth. Fragmentation Control field contains fragmentation-specific control information; see [DOCSIS MULPIv3.1] for details.

The CM determines whether a packet will be fragmented based on its knowledge of the grant size (i.e., the number of mini-slots a CMTS grants to a CM in an Upstream Bandwidth Allocation MAP [DOCSIS MULPIv3.1]). If an encrypted packet is to be fragmented, the CM MUST perform encryption on a fragment-by-fragment basis, not over the PDU as a whole; each fragment will, therefore, have its own fragmentation header and be encrypted separately.

6.5 Registration Request (REG-REQ-MP) MAC Management Messages

When EAE is enabled, the CM MUST encrypt REG-REQ-MP MAC management messages (see Section 9.5). Figure 6-1 depicts the format of a DOCSIS MAC management message frame with a Privacy Extended Header (EH) Element and encrypted payload.

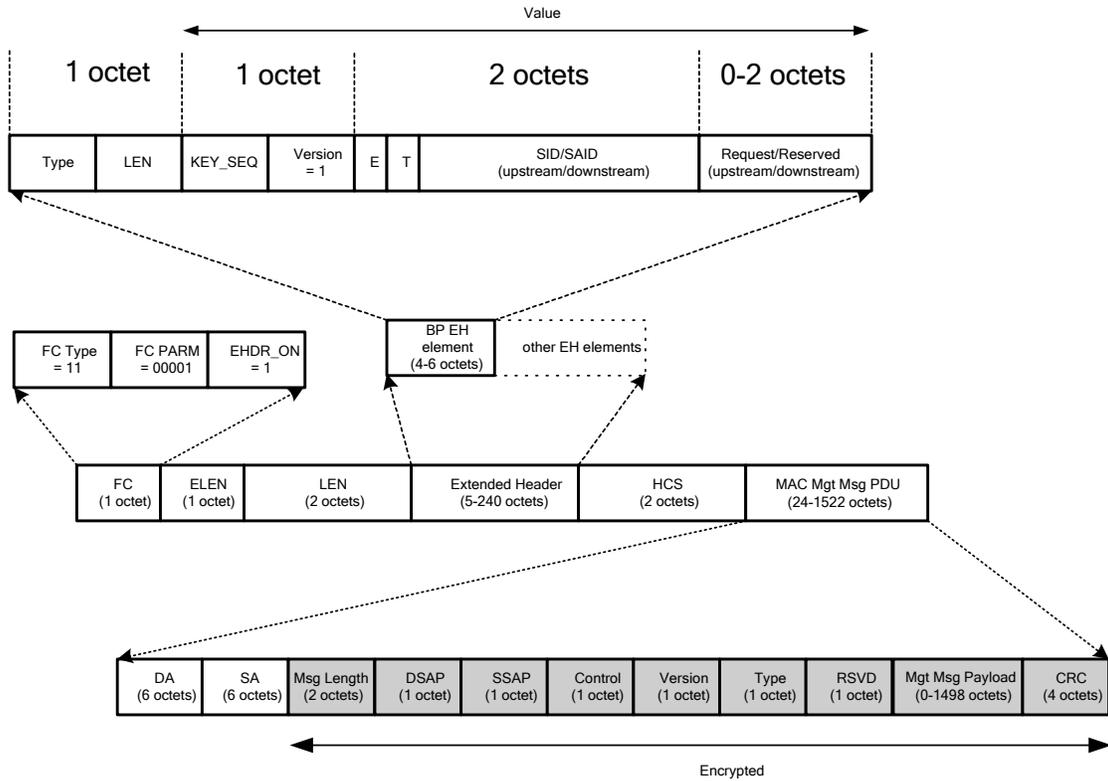

Figure 6-3 - Format of a DOCSIS MAC Management Message Frame with Encrypted Payload

The CM MUST encrypt REG-REQ-MP MAC management message frames according to the following rules:

- The first twelve (12) octets of the PDU, containing the Ethernet/802.3 destination and source addresses (DA/SA) MUST NOT be encrypted;
- The CM MUST encrypt the PDU's Ethernet/802.3 CRC;
- A Baseline Privacy Extended Header MUST be included in the frame;
- The Baseline Privacy Extended Header element MUST be the first Extended Header in the upstream frame;
- The Upstream frames MUST contain the Type value BP_UP in the Baseline Privacy EH;
- The four (4) bits following KEY_SEQ contain a protocol version number, which MUST have the value one (1);
- The next two octets contain two (2) bits of encryption status (ENABLE and TOGGLE) and the fourteen (14) bit SID. The ENABLE bit MUST have the value one (1);
- The TOGGLE bit MUST match the value of the Least Significant Bit (LSB) of KEY_SEQ.

Table 6-3 - Summary of the Contents of DOCSIS MAC Management Message Baseline Privacy Extended Headers

TYPE	LENGTH	VALUE
BP_UP See [DOCSIS MULPiv3.1]	4	KEY_SEQ (4 bits), Version (4 bits), SID (2 octets), Request [piggyback] (1 octet) [CM → CMTS] KEY_SEQ field (4 bits): Key sequence number Version field (4 bits) is defined as: 0x1 SID field is defined as: Bit[15]: ENABLE: 1⇒Encryption enabled; 0⇒Encryption Disabled Bit[14]: TOGGLE: 1⇒Odd Key; 0⇒Even Key Bit[13:0]: Service ID. Request field contains the number of mini-slots requested for upstream bandwidth.
BP_UP2 See [DOCSIS MULPiv3.1]	3	KEY_SEQ (4 bits), Version (4 bits), SID (2 octets) [CM → CMTS] KEY_SEQ field (4 bits): Key sequence number Version field (4 bits) is defined as: 0x1 SID field is defined as: Bit[15]: ENABLE: 1⇒Encryption enabled; 0⇒Encryption Disabled Bit[14]: TOGGLE: 1⇒Odd Key; 0⇒Even Key Bit[13:0]: Service ID.
BP_UP2 See [DOCSIS MULPiv3.1]	5	KEY_SEQ (4 bits), Version (4 bits), SID (2 octets), Request [piggyback] (2 octets) [CM → CMTS] KEY_SEQ field (4 bits): Key sequence number Version field (4 bits) is defined as: 0x1 SID field is defined as: Bit[15]: ENABLE: 1⇒Encryption enabled; 0⇒Encryption Disabled Bit[14]: TOGGLE: 1⇒Odd Key; 0⇒Even Key Bit[13:0]: Service ID. Request field contains the number of octets requested for upstream bandwidth.

6.6 Use of the Baseline Privacy Extended Header in the MAC Header

If encryption is not enabled on a particular downstream traffic flow (e.g., a CM's unicast traffic, or a particular IP multicast group), the CMTS SHOULD NOT place a BP Extended Header element in the frame.

If encryption is not enabled for a CM's unicast traffic, the CM MUST include the Baseline Privacy Extended Header element with the ENABLE bit set to 0 in fragmented upstream frames.

If a CM sends a MAC frame consisting of only a MAC header and, optionally, an EHDR, the CM MUST disable encryption on that frame. If Baseline Privacy EHDR is present on such a frame, the CM MUST set the ENABLE bit to zero (0).

If a CMTS sends a MAC frame consisting of only a MAC header and, optionally, an EHDR, the CMTS MUST disable encryption on that frame. If a Baseline Privacy EHDR is present on such a frame, the CMTS MUST set the ENABLE bit to zero (0).

7 BASELINE PRIVACY KEY MANAGEMENT (BPKM) PROTOCOL

7.1 State Models

7.1.1 Introduction

The BPKM protocol is controlled by two separate but interdependent state machines: an Authorization state machine and a TEK state machine. This section describes these two state machines. The state machines are presented here for explanatory purposes only, and are not to be construed as constraining an actual implementation. However, the external behavior of CMTS implementations **MUST** be identical to the state machines described in this section. The external behavior of CM implementations **MUST** be identical to the state machines described in this section.

CM authorization, controlled by the Authorization state machine, is the process of:

- the CMTS authenticating a client CM's identity;
- the CMTS providing the authenticated CM with an Authorization Key, from which a Key Encryption Key (KEK) and message authentication keys are derived;
- the CMTS providing the authenticated CM with the identities (i.e., the SAIDs) and properties of primary and static security associations for which the CM is authorized to obtain keying information.

The KEK is a two-key, 3DES encryption key that the CMTS uses to encrypt Traffic Encryption Keys (TEKs) that it sends to the CM. TEKs are used to encrypt and decrypt user data traffic, and REG-REQ-MP MAC management messages. The CM and CMTS use message authentication keys to authenticate, via a keyed message digest, the key requests and responses that they exchange.

After achieving initial authorization, a CM periodically seeks reauthorization with the CMTS; reauthorization is managed by the CM's Authorization state machine. A CM maintains its authorization status with the CMTS in order to be able to refresh TEKs. TEK state machines manage the refreshing of Traffic Encryption Keys.

7.1.1.1 Authorization State Machine Overview

A CM begins the authorization process by sending an Authentication Information message to its CMTS. The Authentication Information message contains the Device CA Certificate, issued by the Root CA. The Authentication Information message is usually informative, (i.e., the CMTS may ignore it under some circumstances); however, it does provide a mechanism for a CMTS to learn these CA certificates from its client CMs (see Section 7.1.4.2.5 for more details).

Immediately after sending the Authentication Information message, the CM sends an Authorization Request message to the CMTS. This is a request for an Authorization Key and for the SAIDs that identify any Static Security Associations in which the CM is authorized to participate. The Authorization Request contains:

- The CM's manufacturer ID and serial number;
- The CM's MAC address;
- The CM's public key;
- A CM Device Certificate binding the CM's public key to its other identifying information;⁵
- A description of the cryptographic algorithms supported by the CM. A CM's cryptographic capabilities are presented to the CMTS as a list of cryptographic suite identifiers, each indicating a particular pairing of packet data encryption and packet data authentication algorithms, supported by the CM;
- The Initialization SAID (see Section 7.2.1.1). To support backward compatibility with Pre-3.0 DOCSIS CMTSs, the CM will use different values for its Initialization SAID. Since Pre-3.0 DOCSIS CMTSs do not send an MDD MAC message, it is used to determine what value the CM uses for the Initialization SAID. The CM **MUST** use a value of zero for the Initialization SAID when it has received an MDD MAC message from

⁵ This means that the public key appears twice in the message, once as a standalone entity and once as part of the certificate.

the CMTS. The CM MUST use a value equal to the Primary SID for the Initialization SAID when it has not received an MDD MAC message from the CMTS. The CMTS MUST interpret a SAID value of zero as an Initialization SAID.

In response to an Authorization Request message, the CMTS:

- Verifies the CM Device Certificate;
- Checks that the CMTS and the CM share at least one cryptographic suite;
- Assigns the CM's Primary SAID.

In addition, the CMTS MUST verify that the MAC-address attribute of the Auth Request, the MAC address in the CM's Device certificate, and the source MAC address of the Auth Request MAC message, all match.

Furthermore, the CMTS SHOULD, by means that are outside the scope of this specification, determine whether the CM is authorized to receive service and, if so, whether it is entitled to access services that are served by any Static SAs.

If these conditions are met, the CMTS MUST:

1. Create an Authorization Key for the CM;
2. Encrypt the Authorization Key with the CM's public key; and
3. Send the encrypted Authorization Key to the CM in an Authorization Reply message.

The Authorization Reply contains:

- An Authorization Key encrypted with the CM's public key;
- A four (4) bit key sequence number;
- A key lifetime;
- The identities (i.e., the SAIDs) and properties of the Primary and zero or more Static Security Associations for which the CM is authorized to obtain keying information.

If the CMTS supports Static SAs, the CMTS MUST include in the Authorization Reply the identities of all Static SAs associated with the CM, in addition to the Primary SA. The CMTS MUST NOT identify any Dynamic SAs (see Section 7.1.2) in the Authorization Reply. Upon receiving an Authorization Reply, the CM MUST start a separate TEK state machine for each of the SAIDs identified in the Authorization Reply message (see Section 7.2.1.2). Dynamic SAs are not included in the Authorization Reply and, therefore, are not shown in Figure 7-1.

7.1.1.2 TEK State Machine Overview

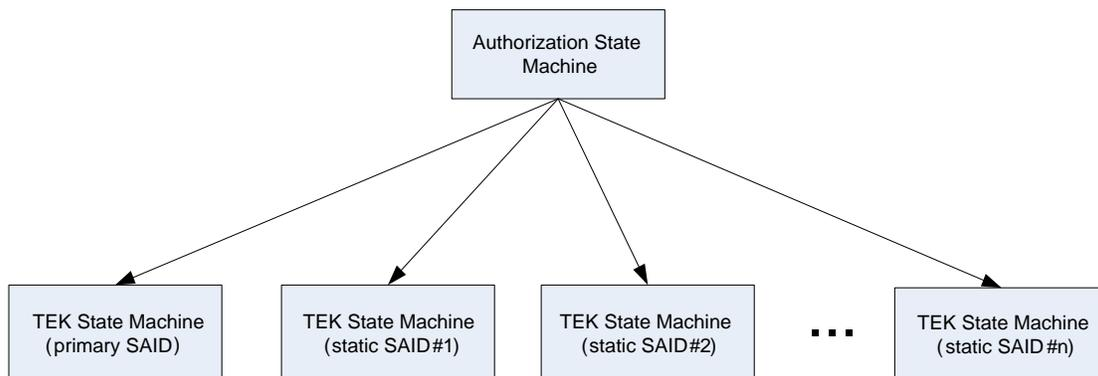

Figure 7-1 - Relationship among Authorization and TEK State Machines

Each TEK state machine is responsible for managing the keying material associated with its respective SAID. TEK state machines send Key Request messages to the CMTS, requesting initial and subsequent keying material for their respective SAIDs. A Key Request contains:

- Identifying information unique to the CM, consisting of the manufacturer ID, serial number, MAC address and RSA Public Key;
- The SAID whose keying material is being requested;
- An HMAC keyed message digest, authenticating the Key Request.

The CMTS checks the HMAC digest of the Key Request message (see Sections 11 and 12). If the CMTS verifies the HMAC, the CMTS MUST respond with a Key Reply message containing the CMTS's active keying material for the specific SAID. This keying material includes:

- The 3DES-encrypted Traffic Encryption Key (TEK);
- A Cipher Block Chaining (CBC) initialization vector;
- The key sequence number;
- The key's remaining lifetime; and
- An HMAC keyed message digest.

The TEK in the Key Reply is 3DES (EDE mode) encrypted, using a two-key, 3DES Key Encryption Key (KEK), derived from the Authorization Key (see Section 11.2).

At all times, the CMTS maintains two active sets (called "generations") of keying material for each SAID. A CMTS includes in its Key Replies, both of a SAID's currently-valid generations of keying material.

In addition to the TEK and CBC initialization vector, the Key Reply contains the remaining lifetime of each of the two sets of keying material. The CM uses these remaining lifetimes to estimate when to schedule Key Requests, such that the CM requests and receives new keying material before the CMTS invalidates the keying material currently held by the CM.

The operation of the TEK state machine's Key Request scheduling algorithm, combined with the CMTS's process for updating and using a SAID's keying material, ensures that the CM will be able at all times to exchange encrypted traffic with the CMTS.

Before the current Authorization Key expires, the CM obtains a new Authorization Key, by issuing an Authorization Request to the CMTS. This "reauthorization" is identical to authorization, with the exception that the CM does not send an Authentication Information message. The specification of the authorization state machine defines when Authentication Information messages are sent (see Section 7.1.4).

To avoid service interruptions during reauthorization, successive generations of the CM's Authorization Keys have overlapping lifetimes. The CM MUST be able to support at least two simultaneously active Authorization Keys. The CMTS MUST be able to support at least two simultaneously active Authorization Keys for each registered CM. The operation of the Authorization state machine's Authorization Request scheduling algorithm, combined with the CMTS's process for updating and using a CM's Authorization Keys, ensures that CMs will be able to refresh TEK keying information without interruption over the course of the CM's reauthorization periods.

A TEK state machine remains active as long as:

- The CM has a valid Authorization Key; and
- The CMTS continues to provide fresh keying material during TEK re-key cycles.

The parent Authorization state machine stops all its child TEK state machines (see Figure 7-1), when the CM receives an Authorization Reject during a reauthorization cycle. Individual TEK state machines can be started or stopped during a reauthorization cycle if a CM's Static SAID authorizations change between successive reauthorizations.

Communication between Authorization and TEK state machines occurs through the passing of events (directly or indirectly) between the two state machines. The Authorization state machine generates events ({Stop},

{Authorized}, {Authorization Pending}, and {Authorization Complete}) that are sent directly to all its child TEK state machines. TEK state machines, however, cannot directly send events to their parent Authorization state machine.

A TEK state machine affects its parent Authorization state machine indirectly through the messaging a CMTS sends in response to a CM's requests: a CMTS may respond to a TEK machine's Key Requests with a failure response (i.e., an Authorization Invalid message) that will be handled by the Authorization state machine. In other words, the TEK state machine might transmit a Key Request to the CMTS, which may respond with an Authentication Invalid message. This message is handled not by the TEK state machine responsible for transmitting the Key Request but by its parent Authorization state machine.

7.1.2 Encrypted Multicast

The message exchange between the CMTS and the CM for the signaling and initialization of multicast traffic encryption is dependent on the type of multicast session, on the capabilities of the modem, and on the multicast forwarding mode selected by the CMTS. The CMTS selects a multicast forwarding mode within the multicast forwarding capabilities reported by the CM.

Multicast sessions can be established dynamically when a Multicast Client sends a join request (IGMP for IPv4 and MLD for IPv6) message. Such multicast sessions are called Dynamically-joined Multicast Sessions. The cable operator can configure the cable modem to join multicast sessions during registration. Such multicast sessions are called Static Multicast Sessions [DOCSIS MULPIv3.1].

A CM indicates support for DSID Multicast Forwarding in the Registration Request message with a Multicast DSID Forwarding capability encoding. A CM that reports in this encoding the value of either 1 (GMAC-Explicit) or 2 (GMAC-Promiscuous) is said to support Multicast DSID forwarding. A CM that omits this encoding or that reports in it a value of 0 (No Support for Multicast DSID Forwarding) is said not to support MDF. The CMTS enables MDF at a CM that supports MDF by setting the MDF capability encoding to the value 1 or 2 in the Registration Response it sends to the modem; such a CM is said to be an MDF enabled CM. The CMTS may disable MDF at a CM that supports MDF by setting the MDF capability encoding to the value 0 in the Registration Response it sends to the modem [DOCSIS MULPIv3.1]; such a CM is said to be an MDF disabled CM.

Security Associations are used to support encrypted multicast sessions. SA descriptors containing the SAID, the SA type, and cryptographic suite for encrypted Multicast sessions are included in Auth Reply, REG-RSP(-MP) and DBC-REQ MAC messages and are used by the CM to create or delete the corresponding TEK state machines (see [DOCSIS MULPIv3.1]). The CMTS typically communicates in REG-RSP Dynamic SAs associated with static multicast sessions. The CMTS typically communicates in DBC-REQ Dynamic SAs associated with multicast sessions that are explicitly joined via multicast management protocols such as IGMP/MLD. Note that a REG-RSP may both enable DSID Multicast forwarding and include added Security Associations.

7.1.2.1 Signaling of Dynamic and Static Multicast Session SAs when MDF is Disabled

If a CM does not support Multicast DSID Forwarding, the CMTS MUST NOT signal Dynamic SAs to the CM in a REG-RSP or DBC-REQ message. For CMs that do not support MDF, the CMTS MUST signal SAs using the DOCSIS 1.1/2.0 Dynamic Security Association mechanism described in Annex C. For backwards compatibility, the CM MUST support dynamic SA-MAP messaging as described in Annex C.

If the CMTS disables MDF for a CM that supports MDF, the CMTS MUST NOT signal SAs used for encrypted multicast sessions using DBC-REQ to this CM. The CMTS may signal SAs for other purposes to MDF-disabled CMs using DBC-REQ or REG-RSP(-MP). The CM MUST accept SA Descriptor Encodings in REG-RSP (-MP), even if this message disables MDF. If the CMTS disables MDF on a CM that supports MDF, the CMTS MUST signal SAs for encrypting IP multicast traffic to this CM using the DOCSIS 1.1/2.0 Dynamic Security Association mechanism described in Annex C. If the CMTS disables MDF, the CM MUST signal SAs using the DOCSIS 1.1/2.0 Dynamic Security Association mechanism described in Annex C.

Note that a CMTS may communicate static SAs to an MDF-disabled CM in the BPI+ Auth Reply. Such SAs may be used for encrypting Static Multicast sessions. The CM accepts static SAs in BPI+ Auth Reply messages, even when it operates in MDF disabled mode.

7.1.2.2 Signaling of Dynamic and Static Multicast Session SAs when MDF is Enabled

When the CMTS enables Multicast DSID Forwarding for a CM in the REG-RSP(-MP) [DOCSIS MULPIv3.1], the CM MUST NOT transmit Dynamic SA MAP Requests to the CMTS. The CMTS MUST respond with an SA Map Reject message containing error code 7 if it receives an SA Map Request from an MDF enabled CM.

A CMTS MAY signal in a DBC-REQ the deletion of Dynamic SAs known to the CM. When the MDF enabled CM receives a DBC-REQ that deletes a Dynamic SA, the CM MUST terminate the corresponding TEK state machine prior to sending the DBC-RSP, and remove the Dynamic SA's keying material from the CM's key table. This CM MUST discontinue decryption on an SA deleted through a DBC-REQ message. A CM MUST indicate an error response to an attempt to delete an unknown SA.

For encrypting multicast sessions (static or dynamic) forwarded through the MDF-enabled CM, the CMTS MUST use SAs ONLY of type 'Dynamic.' The CMTS MUST NOT signal SAs for multicast sessions in BPI Auth Reply messages to an MDF-enabled CM.

The CMTS is allowed to signal SAs in BPI Auth Reply messages for purposes other than multicast encryption to an MDF-enabled CM. The CM accepts static SAs in BPI+ Auth Reply messages, even when it operates in MDF enabled mode.

7.1.2.2.1 Requirements Specific to the Signaling of Dynamic SAs for Dynamic Multicast Sessions

SA descriptors for encrypted multicast sessions joined dynamically are communicated to the MDF enabled CM in a DBC-REQ message. If a dynamic multicast session is encrypted, the CMTS MUST communicate in a DBC-REQ message the session SA Descriptor to an MDF enabled CM. The CMTS MUST set the SA Type in the DBC-REQ message to 'Dynamic' for a dynamic multicast session. A CM for which the CMTS has enabled DSID Multicast Forwarding MUST accept in a DBC-REQ one or more Security Association Encodings that add a new SA of type dynamic.

The CMTS MUST NOT send a Dynamic SA in DBC-REQ messages if BPI+ is disabled for a CM.

When an authorized CM receives a DBC-REQ that contains a Dynamic SA, the CM MUST start a TEK state machine for the Dynamic SA prior to sending a DBC-RSP message. The CMTS MUST NOT send a DBC-REQ with a Dynamic SA to a CM that is not in the "Authorized" State. If an unauthorized CM receives a DBC-REQ message that adds a Dynamic SA, the CM MUST reject the DBC-REQ message. The CMTS is allowed to send a DBC-REQ with an SA that employs a cryptographic suite unsupported by the CM. If an authorized CM receives a DBC-REQ message that adds a Dynamic SA having an unsupported cryptographic suite, the CM MUST reject the DBC-REQ message. If a CM receives a DBC-REQ message adding a Dynamic SA, in which the TEK state machine for that Dynamic SA is already active, the CM MUST reject the DBC-REQ message.

7.1.2.2.2 Requirements Specific to the Signaling of Dynamic SAs for Static Multicast Sessions

SA descriptors for encrypted multicast sessions joined statically are communicated to the MDF enabled CM in the REG-RSP(-MP) message. If the Static Multicast Session is encrypted, the CMTS MUST communicate in REG-RSP(-MP) the session SA Descriptor to an MDF enabled CM. The CMTS MUST set the SA Type in the REG-RSP(-MP) message to 'Dynamic' for a static multicast session. A CM for which the CMTS has enabled DSID Multicast Forwarding MUST accept in a REG-RSP(-MP) one or more Security Association Encodings that add a new SA of type dynamic.

The CMTS MUST NOT send a Dynamic SA in REG-RSP(-MP) if BPI+ is disabled for a CM.

When an authorized CM receives a REG-RSP(-MP) that adds a Dynamic SA, the CM MUST start a TEK state machine for that Dynamic SA. When an unauthorized CM receives a REG-RSP(-MP) that adds a Dynamic SA, the CM MUST wait until it reaches its Authorized state before starting a TEK state machine for that Dynamic SA. The CMTS is allowed to send a REG-RSP(-MP) with an SA that employs a cryptographic suite unsupported by the CM. If the CM receives a REG-RSP(-MP) message that adds a Dynamic SA having an unsupported cryptographic suite, the CM MUST reject the REG-RSP(-MP) message.

7.1.3 Selecting Cryptographic Suites

As part of their authorization exchange, the CM provides the CMTS with a list of supported cryptographic suites. The CMTS selects from this list a single suite to use with the CM's Primary SA. In the Authorization Reply, the CMTS includes a Primary SA descriptor that identifies the cryptographic suite selected by the CMTS. A CMTS MUST reject the Authorization Request if none of the offered cryptographic suites is permitted by local policy.

The Authorization Reply may contain a list of Static SA descriptors; each Static SA descriptor identifies the cryptographic suite employed by that SA. The selection of a static SA's cryptographic suite is independent of the requesting CM's cryptographic capabilities. A CMTS MAY include in its Authorization Reply Static SA descriptors identifying cryptographic suites unsupported by the CM. The CM MUST NOT start TEK state machines for SAs whose cryptographic suites the CM does not support.

7.1.4 Authorization State Machine

The Authorization Finite State Machine (FSM) contains six states and ten events. The Authorization FSM is presented below as a state flow diagram (Figure 7-2) and as a state transition matrix (Table 7-1).

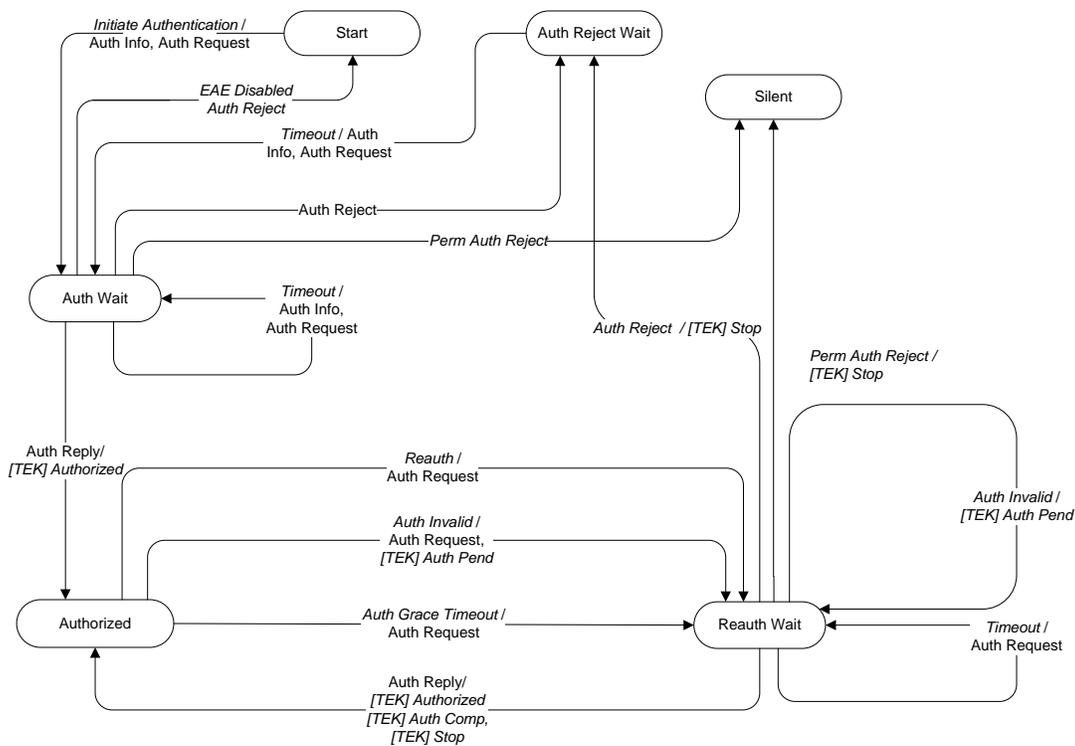

Figure 7-2 - Authorization State Machine Flow Diagram

Table 7-1 - Authorization FSM Transition Matrix

State Event or Received Message	[Start]	[Auth Wait]	[Authorized]	[Reauth Wait]	[Auth Reject Wait]	[Silent]
{Initiate Authentication}	[Auth Wait]					
{Auth Reject}		[Auth Reject Wait]		[Auth Reject Wait]		
{Perm Auth Reject}		[Silent]		[Silent]		
{EAE Disabled Auth Reject}		[Start]				

State Event or Received Message	[Start]	[Auth Wait]	[Authorized]	[Reauth Wait]	[Auth Reject Wait]	[Silent]
{Auth Reply}		[Authorized]		[Authorized]		
{Timeout}		[Auth Wait]		[Reauth Wait]	[Auth Wait]	
{Auth Grace Timeout}			[Reauth Wait]			
{Auth Invalid}			[Reauth Wait]	[Reauth Wait]		
{Reauth}			[Reauth Wait]			

The state flow diagram depicts the protocol messages transmitted and internal events generated for each of the machine's state transitions; however, the diagram does not indicate additional internal actions, such as the clearing or starting of timers that accompany the specific state transitions. Accompanying the state transition matrix is a detailed description of the specific actions accompanying each state transition. The CM MUST use the text associated with the state transition matrix as the definitive specification of protocol actions associated with each state transition.

The following legend applies to Figure 7-3:

- States are represented by ovals;
- Events appear in italics;
- Messages appear in normal font;
- State transitions (i.e., the lines between states) are labeled in the manner of "<what causes the transition>/<messages and events triggered by the transition>." So "timeout/Auth Request" means that the state received a "timeout" event and sent an Auth Request message. If there are multiple comma-separated events or messages before the slash "/", any of them can cause the transition. If there are multiple events or messages listed after the slash, all the identified actions accompany the transition.

The Authorization state transition matrix, presented in Table 7-1, lists the states in the topmost row and the events in the left-most column. Cells within the matrix represent a specific combination of state and event, with the next state (the state to which the machine transitioned) displayed within the cell. For example, one cell represents the receipt of an Authorization Reply message when in the [Auth Wait] state. Within this cell is the name of the next state, [Authorized]. Thus, when a CM's Authorization state machine is in the [Auth Wait] state and an Authorization Reply message is received, the Authorization state machine will transition to the [Authorized] state. In conjunction with this state transition, several protocol actions are taken; these are described in Section 7.1.4.7.

A shaded cell within the state transition matrix (Table 7-1), implies that the specific event should not occur within that state. If the event does occur, the CM MUST NOT transition to another state. For example, if an Authorization Reply message arrives when in the [Authorized] state, that message will not cause any state transition to occur. The CM MAY, in response to such an improper event, log the event's occurrence, generate an SNMP event, or take some other vendor-defined action.

7.1.4.1 Brief Description of States

7.1.4.1.1 [Start]

This is the initial state of the FSM. No resources are assigned to or used by the FSM, all timers are off, and no processing is scheduled.

7.1.4.1.2 [Auth Wait]

The CM has received the {Initiate Authentication} event. In response to receiving the event, the CM has sent both an Authentication Information and an Authorize Request message and is waiting for the reply.

7.1.4.1.3 *[Authorized]*

The CM has received an Authorization Reply message that contains a list of valid SAIDs for this CM. The CM has a valid Authorization Key and the list of SAIDs. Transition into this state triggers the creation of one TEK FSM for each of the CM's privacy-enabled SAIDs.

7.1.4.1.4 *[Reauth Wait]*

The CM has an outstanding reauthorization request. The CM's current authorization is about to time-out, or the CM has received an indication (an Authorization Invalid message) that its authorization is no longer valid. The CM has sent an Authorization Request message to the CMTS and is waiting for a response.

7.1.4.1.5 *[Auth Reject Wait]*

The CM received an Authorization Reject message in response to its last Authorization Request. The error code in the Authorization Reject indicated that the error was not permanent or that EAE is not disabled. In response to receiving this reject message, the CM sets a timer and transitioned to the [Auth Reject Wait] state. The CM remains in this state until the timer expires.

7.1.4.1.6 *[Silent]*

The CM received an Authorization Reject message in response to its last Authorization Request. The Authorization Reject's error code indicated that the error was permanent. This triggers a transition to the [Silent] state.

In the [Silent] state, the CM

- MUST NOT pass CPE traffic; and
- If the CM has a valid IP address, it MUST respond to SNMP management requests arriving from the cable network.

The CMTS may send unencrypted data traffic to a CM on a SAID for which it has sent an Authorization Reject message, or the CMTS may block such traffic.

7.1.4.2 **Brief Description of Messages**

The corresponding message formats are specified in Section 7.2.

7.1.4.2.1 *Authorization Request (Auth Request)*

Request an Authorization Key and a list of authorized SAIDs. The Authorization Request is sent from the CM to CMTS.

7.1.4.2.2 *Authorization Reply (Auth Reply)*

Receive an Authorization Key and list containing the primary SAID and static SAIDs. The Authorization Reply is sent from CMTS to CM. The Authorization Key is encrypted with the CM's public key.

7.1.4.2.3 *Authorization Reject (Auth Reject)*

The attempt to authorize was rejected. The Authorization Reject is sent from the CMTS to CM.

7.1.4.2.4 *Authorization Invalid (Auth Invalid)*

The CMTS can send an Authorization Invalid message to a client CM as:

- An unsolicited indication; or
- A response to a message received from that CM.

In either case, the Authorization Invalid message instructs the receiving CM to re-authorize with its CMTS.

The CMTS MUST respond to a Key Request with an Authorization Invalid message if:

1. There is no valid Authorization Key associated with the CM; or
2. Verification of the Key Request's keyed message digest (in the HMAC-Digest Attribute) failed.

7.1.4.2.5 Authentication Information (Auth Info)

The Authentication Information message contains the intermediate CA Certificate, issued by the Root CA (see Section 13). The Auth Info message is a message sent by the CM to the CMTS. The CMTS MUST first use the out-of-band configuration information to obtain the intermediate CA certificate (see Section 13.3.2). If the CMTS does not learn the intermediate CA certificate from the out-of-band configuration information, then the CMTS MUST use the intermediate CA certificate from the Auth Info message sent by the CM.

7.1.4.3 Brief Description of Events

7.1.4.3.1 {Initiate Authentication}

The CM sends an {Initiate Authentication} event to the Authorization FSM upon completing CMTS registration or when it completes ranging if EAE is enabled. If the configuration file contains a BPI+ enable setting (see Annex A.1.1) and the CM has not yet enabled BPI+, the {Initiate Authentication} event causes the CM to begin the process of obtaining its Authorization Key and transitions to the [Auth Wait] state.

7.1.4.3.2 {Timeout}

This event indicates that a retransmission or wait timer timed out. Generally, a request is resent.

7.1.4.3.3 {Auth Grace Timeout}

This event indicates that the Authorization Grace timer fired. This timer fires a configurable duration (the Authorization Grace Time) before the current authorization expires, signaling the CM to re-authorize before its authorization actually expires. Once the configuration file has been received by the CM, the Authorization Grace Time is obtained from a value in that file; prior to that time, the value of the Authorization Grace Time MUST be the default defined in Annex A.

7.1.4.3.4 {Reauth}

This event is generated in response to an SNMP SET [DOCSIS CM-OSSIV3.1] that is intended to trigger a reauthorization cycle because the CM's set of authorized static SAIDs may have changed.

7.1.4.3.5 {Auth Invalid}

This event is generated when there is a failure authenticating a Key Reply, Key Reject or TEK Invalid message, or when the CM receives an Authorization Invalid message. A CMTS responds to a Key Request with an Authorization Invalid message if verification of the request's message authentication code fails. Generation of an {Auth Invalid} event indicates that the CMTS and the CM have lost Authorization Key synchronization.

A CMTS MAY send an unsolicited Authorization Invalid message to a CM, forcing an {Auth Invalid} event.

7.1.4.3.6 {Perm Auth Reject}

This event indicates receipt of an Authorization Reject message containing error code 6. When a CM receives an Authorization Reject containing error code 6, the Authorization State machine moves to the [Silent] state.

7.1.4.3.7 {Auth Reject}

This event indicates that the CM has received an Authorization Reject in response to an Authorization Request, and that the error code in the Authorization Reject had some value other than 6 or 10. The CM's Authorization state

machine will set a wait timer and transition into the [Auth Reject Wait] state. The CM remains in this state until the timer expires, at which time it will re-attempt authorization.

7.1.4.3.8 {EAE Disabled Auth Reject}

This event indicates that the CM has received an Authorization Reject message containing error code 10 in response to an Authorization Request that was sent to the CMTS as part of EAE. Authorization Reject error code 10 messages are sent to CMs that have been specifically configured in the CMTS to have EAE disabled. When receiving this message, the CM's Authorization state machine will transition to the [Start] state.

7.1.4.4 Events Sent to TEK State Machine

The following events are sent by the Authorization state machine to a TEK state machine.

7.1.4.4.1 {TEK Stop}

Sent by the Authorization FSM to a TEK FSM that is not in the [Start] state, to terminate the TEK FSM and remove the corresponding SAID's keying material.

7.1.4.4.2 {TEK Authorized}

Sent by the Authorization FSM to a TEK FSM that is in the [Start] state.

7.1.4.4.3 {Auth Pend}

This message is sent by the Authorization FSM to a TEK FSM to place that TEK FSM into a wait state until the Authorization FSM can complete a reauthorization operation.

7.1.4.4.4 {Auth Comp}

Sent by the Authorization FSM to a TEK FSM in the [Op Reauth Wait] or [Rekey Reauth Wait] states, to clear the wait state begun by a {Auth Pend} event.

7.1.4.5 Brief Description of Timing Parameters

All configuration parameter values are contained in the configuration file (see Annex A).

7.1.4.5.1 Authorize Wait Timeout (Auth Wait Timeout)

This is the timeout period between sending Authorization Request when in message the [Auth Wait] state.

7.1.4.5.2 Reauthorize Wait Timeout (Reauth Wait Timeout)

This is the timeout period between sending Authorization Request messages when in the [Reauth Wait] state.

7.1.4.5.3 Authorization Grace Time (Auth Grace Timeout)

Amount of time before authorization is scheduled to expire that the CM starts the process of reauthorization.

7.1.4.5.4 Authorize Reject Wait Timeout (Auth Reject Wait Timeout)

Amount of time that a CM's Authorization FSM remains in the [Auth Reject Wait] state before re-attempting authorization.

7.1.4.6 Timers

7.1.4.6.1 Authorization Request

Used when awaiting a response to Authorization Requests.

7.1.4.6.2 Authorization Reject

Used after receipt of an Authorization Reject.

7.1.4.6.3 Authorization Grace

Used when determining when to reauthorize.

7.1.4.7 Actions

The CM MUST take the following actions in association with state transitions:

[Start] + {Initiate Authentication} --> [Auth Wait]:

- Send Authentication Information message to CMTS;
- Send Authorization Request message to CMTS;
- Set Authorization Request timer to Authorize Wait Timeout.

[Auth Wait] + {Auth Reject} --> [Auth Reject Wait]:

- Clear Authorization Request timer;
- Set Authorization Reject timer to Authorize Reject Wait Timeout.

[Reauth Wait] + {Auth Reject} --> [Auth Reject Wait]:

- Clear Authorization Request timer;
- Generate TEK FSM {Stop} events for all active TEK state machines;
- Set Authorization Reject timer to Authorize Reject Wait Timeout.

[Auth Wait] + {Perm Auth Reject} --> [Silent]:

- Clear Authorization Request timer;
- Disable all forwarding of CPE traffic.

[Auth Wait] + {EAE Disabled Auth Reject} --> [Start]:

- Clear Authorization Request timer.

[Reauth Wait] + {Perm Auth Reject} --> [Silent]:

- Clear Authorization Request timer;
- Generate TEK FSM {Stop} events for all active TEK state machines;
- Disable all forwarding of CPE traffic.

[Auth Wait] + {Auth Reply} --> [Authorized]:

- Clear Authorization Request timer;
- Decrypt and record Authorization Key delivered with Authorization Reply;
- Start TEK FSMs for all SAIDs listed in Authorization Reply and any pending Dynamic SAIDs received in Registration Response, (provided that the CM supports the cryptographic suite that is associated with a SAID) and issue a TEK FSM {Authorized} event for each of the new TEK FSMs;
- Set the Authorization Grace timer to fire "Authorization Grace Time" seconds prior to the supplied Authorization Key's scheduled expiration.

[Reauth Wait] + {Auth Reply} --> [Authorized]:

- Clear Authorization Request timer;

- Decrypt and record Authorization Key delivered with Authorization Reply;
- Start TEK FSMs for any newly authorized SAIDs listed in Authorization Reply (provided that the CM supports the cryptographic suite that is associated with the new SAID) and issue TEK FSM {Authorized} events for each of the new TEK FSMs;
- Generate TEK FSM {Authorization Complete} events for any currently active TEK FSMs whose corresponding SAIDs were listed in Authorization Reply;
- Generate TEK FSM {Stop} events for any currently active TEK FSMs whose corresponding primary or Static SAIDs were not listed in Authorization Reply;
- Set the Authorization Grace timer to fire "Authorization Grace Time" seconds prior to the supplied Authorization Key's scheduled expiration.

[Auth Wait] + {Timeout} --> [Auth Wait]:

- Send Authentication Information message to CMTS;
- Send Authorization Request message to CMTS;
- Set Authorization Request timer to Authorize Wait Timeout.

[Reauth Wait] + {Timeout} --> [Reauth Wait]:

- Send Authorization Request message to CMTS;
- Set Authorization Request timer to Reauthorize Wait Timeout.

[Auth Reject Wait] + {Timeout} --> [Auth Wait]:

- Send Authentication Information message to CMTS;
- Send Authorization Request message to CMTS;
- Set Authorization Request timer to Authorize Wait Timeout.

[Authorized] + {Auth Grace Timeout} --> [Reauth Wait]:

- Send Authorization Request message to CMTS;
- Set Authorization Request timer to Reauthorize Wait Timeout.

[Authorized] + {Auth Invalid} --> [Reauth Wait]:

- Clear Authorization Grace timer;
- Send Authorization Request message to CMTS;
- Set Authorization Request timer to Reauthorize Wait Timeout;
- If the Authorization Invalid event is associated with a particular TEK FSM, generate a TEK FSM {Authorization Pending} event for the TEK state machine responsible for the Authorization Invalid event (i.e., the TEK FSM that either generated the event, or sent the Key Request message to which the CMTS responded with an Authorization Invalid message).

[Reauth Wait] + {Auth Invalid} --> [Reauth Wait]:

- If the Authorization Invalid event is associated with a particular TEK FSM, generate a TEK FSM {Authorization Pending} event for the TEK state machine responsible for the Authorization Invalid event (i.e., the TEK FSM that either generated the event, or sent the Key Request message to which the CMTS responded with an Authorization Invalid message).

[Authorized] + {Reauth} --> [Reauth Wait]:

- Clear Authorization Grace timer;
- Send Authorization Request message to CMTS;

- Set Authorization Request timer to Reauthorize Wait Timeout.

7.1.5 TEK State Machine

The TEK state machine contains six states and nine events. The TEK state machine is presented below as both a state flow diagram and a state transition matrix. The CM MUST use the state transition matrix, together with the required actions in Section 7.1.5.6, as the definitive specification of protocol actions associated with each state transition.

Shaded states in Figure 7-3 ({Operational}, {Rekey Wait}, and {Rekey Reauthorize Wait}), indicate that the CM holds valid keying material, so encrypted traffic can be passed.

The Authorization state machine starts an independent TEK state machine for each of its authorized SAIDs.

The CMTS maintains two active TEKs per SAID. The CMTS includes in its Key Replies both of these TEKs, along with their remaining lifetimes. The CMTS encrypts downstream traffic with the older of its two TEKs and decrypts upstream traffic with either the older or newer TEK, depending upon which of the two keys the CM used. The CM encrypts upstream traffic with the newer of its two TEKs and decrypts downstream traffic with either the older or newer key, depending upon which of the two keys the CMTS used. See Sections 10.1 and 10.2 for details on CMTS and CM key usage requirements respectively.

Through operation of a TEK state machine, the CM attempts to keep its copies of a SAID's TEKs, synchronized with those of its CMTS. A TEK state machine issues Key Requests to refresh copies of its SAID's keying material after the scheduled expiration time of the older of its two TEKs and before the expiration of its newer TEK. To accommodate CM/CMTS clock skew and other system processing and transmission delays, the CM schedules its Key Requests a configurable number of seconds (the TEK Grace Time) before the newer TEK expires.

When it receives a Key Reply, the CM MUST immediately begin to use the TEK Parameters from the TEKs contained in the Key Reply Message. Figure 7-3 illustrates the CM's scheduling of key refreshes in conjunction with its management of an SA's active TEKs.

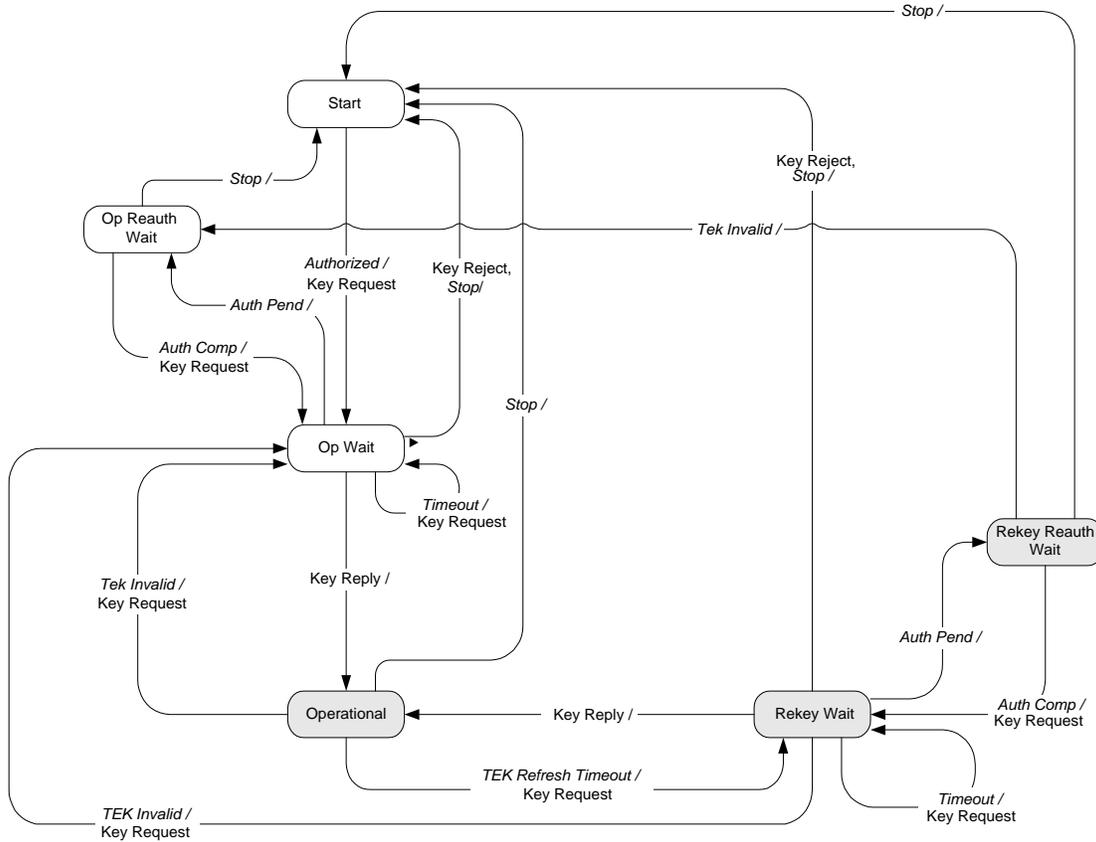

Figure 7-3 - TEK State Machine Flow Diagram

Table 7-2 - TEK FSM State Transition Matrix

State Event or Rcvd Message	[Start]	[Op Wait]	[Op Reauth Wait]	[Op]	[Rekey Wait]	[Rekey Reauth Wait]
{Stop}		[Start]	[Start]	[Start]	[Start]	[Start]
{Authorized}	[Op Wait]					
{Auth Pend}		[Op Reauth Wait]			[Rekey Reauth Wait]	
{Auth Comp}			[Op Wait]			[Rekey Wait]
{TEK Invalid}				[Op Wait]	[Op Wait]	[Op Reauth Wait]
{Timeout}		[Op Wait]			[Rekey Wait]	
{TEK Refresh Timeout}				[Rekey Wait]		
{Key Reply}		[Op]			[Op]	
{Key Reject}		[Start]			[Start]	

7.1.5.1 Brief Description of States

7.1.5.1.1 [Start]

This is the initial state of the FSM. No resources are assigned to or used by the FSM, all timers are off, and no processing is scheduled.

7.1.5.1.2 [Op Wait]

The TEK state machine has sent its initial Key Request for its SAID's keying material (TEK and CBC IV), and is waiting for a reply from the CMTS.

7.1.5.1.3 [Op Reauth Wait]

The Authorization state machine is in a reauthorization cycle and the CM does not have valid keying material for this SAID.

7.1.5.1.4 [Op]

The CM has valid keying material for the associated SAID.

7.1.5.1.5 [Rekey Wait]

The TEK Refresh Timer has expired and the CM has requested a key update for this SAID to replace the older of the two TEKs.

7.1.5.1.6 [Rekey Reauth Wait]

The CM has valid traffic keying material for this SAID; has an outstanding request for the latest keying material; and the Authorization state machine has initiated a reauthorization cycle.

7.1.5.2 Brief Description of Messages

The message formats are defined in detail in Section 7.2. All messages contain a keyed message digest for which the key is derived from the Authorization Key (see Section 11.4).

7.1.5.2.1 Key Request

Request a TEK for this SAID. The Key Request is sent by the CM to the CMTS.

7.1.5.2.2 Key Reply

Response from the CMTS carrying the two active sets of traffic keying material for this SAID. It includes the SAID's TEKs, 3DES encrypted with a Key Encryption Key (KEK) derived from the Authorization Key (see Section 11.4).

7.1.5.2.3 Key Reject

If the SAID in a Key Request message is invalid, the CMTS MUST respond with a Key Reject message.

7.1.5.2.4 TEK Invalid

If the TEK used to encrypt an upstream PDU is invalid, the CMTS MUST respond with a TEK Invalid message.

7.1.5.3 Brief Description of Events

7.1.5.3.1 {Stop}

This event is sent by the Authorization FSM to a TEK FSM not in the [Start] state to terminate the TEK FSM and remove the corresponding SAID's keying material (see Section 7.1.4.4.1).

7.1.5.3.2 {Authorized}

This event is sent by the Authorization FSM to a TEK FSM in the [Start] state to notify the TEK FSM of successful authorization (see Section 7.1.4.4.2).

7.1.5.3.3 {Auth Pend}

This event is sent by the Authorization FSM to a TEK FSM in order to place the TEK FSM in a wait state while the Authorization FSM completes reauthorization (see Section 7.1.4.4.3).

7.1.5.3.4 {Auth Comp}

This event is sent by the Authorization FSM to a TEK FSM in the [Op Reauth Wait] or [Rekey Reauth Wait] states to clear the wait state begun by a prior {Auth Pend} event (see Section 7.1.4.4.4).

7.1.5.3.5 {TEK Invalid}

This event can be triggered either by a CM's data packet decryption logic or by the receipt of a TEK Invalid message from the CMTS.

A CM triggers a {TEK Invalid} event when it recognizes loss of TEK key synchronization between itself and the encrypting CMTS; i.e., a SAID's TEK key sequence number, contained within the received downstream packet's Baseline Privacy Extended Header element, is out of the CM's range of known sequence numbers for that SAID.

A CMTS sends the CM a TEK Invalid message, triggering a {TEK Invalid} event if the CMTS recognizes a loss of TEK key synchronization between itself and the CM.

7.1.5.3.6 {Timeout}

This specifies the period of the Retry Timer timeout. Generally, the original request is retransmitted.

7.1.5.3.7 {TEK Refresh Timeout}

This is the period defined for the TEK Refresh Timer. This event instructs the TEK state machine to issue a new Key Request in order to refresh its keying material. The refresh timer can be configured for a specific length of time (the TEK Grace Time) before the expiration of the newer TEK currently held by the CM elapses.

7.1.5.4 Brief Description of Timing Parameters

All configuration parameter values are contained in the configuration file (see Annex A).

7.1.5.4.1 Operational Wait Timeout

This value specifies the time period between consecutive Key Request messages whenever the state machine is in the [Op Wait] state.

7.1.5.4.2 Rekey Wait Timeout

The timeout period between the sending of Key Request messages when in the [Rekey Wait] state.

7.1.5.4.3 TEK Grace Time

The time interval, in seconds, prior to the expiration of a TEK at which the CM starts re-keying for a new TEK.

7.1.5.5 Timers

7.1.5.5.1 Key Request Retry

Used when the response to a Key Request was not received by the CM.

7.1.5.5.2 TEK Refresh

Used to initiate a request for keys.

7.1.5.6 Actions

The CM MUST take the following actions in association with state transitions:

[Op Wait] + {Stop} --> [Start]:

- Clear Key Request Retry timer;
- Terminate TEK FSM.

[Op Reauth Wait] + {Stop} --> [Start]:

- Terminate TEK FSM.

[Op] + {Stop} --> [Start]:

- Clear TEK Refresh timer;
- Terminate TEK FSM;
- Remove SAID keying material.

[Rekey Wait] + {Stop} --> [Start]:

- Clear Key Request Retry timer;
- Terminate TEK FSM;
- Remove SAID keying material.

[Rekey Reauth Wait] + {Stop} --> [Start]:

- Terminate TEK FSM;
- Remove SAID keying material.

[Start] + {Authorized} --> [Op Wait]:

- Send Key Request Message to CMTS;
- Set Key Request Retry timer to the value of Operational Wait Timeout.

[Op Wait] + {Auth Pend} --> [Op Reauth Wait]:

- Clear Key Request Retry timer.

[Rekey Wait] + {Auth Pend} --> [Rekey Reauth Wait]:

- Clear Key Request Retry timer.

[Op Reauth Wait] + {Auth Comp} --> [Op Wait]:

- Send Key Request message to CMTS;
- Set Key Request Retry timer to Operational Wait Timeout.

[Rekey Reauth Wait] + {Auth Comp} --> [Rekey Wait]:

- Send Key Request message to CMTS;
- Set Key Request Retry timer to Rekey Wait Timeout.

[Op] + {TEK Invalid} --> [Op Wait]:

- Clear TEK Refresh timer;
- Send Key Request message to CMTS;

- Set Key Request Retry timer to Operational Wait Timeout;
- Remove SAID keying material.

[Rekey Wait] + {TEK Invalid} --> [Op Wait]:

- Clear Key Request Retry timer;
- Send Key Request message to CMTS;
- Set Key Request Retry timer to Operational Wait Timeout;
- Remove SAID keying material.

[Rekey Reauth Wait] + {TEK Invalid} --> [Op Reauth Wait]:

- Remove SAID keying material.

[Op Wait] + {Timeout} --> [Op Wait]:

- Send Key Request message to CMTS;
- Set Key Request Retry timer to Operational Wait Timeout.

[Rekey Wait] + {Timeout} --> [Rekey Wait]:

- Send Key Request message to CMTS;
- Set Key Request Retry timer to Rekey Wait Timeout.

[Op] + {TEK Refresh Timeout} --> [Rekey Wait]:

- Send Key Request message to CMTS;
- Set Key Request Retry timer to Rekey Wait Timeout.

[Op Wait] + {Key Reply} --> [Op] (Key Reply passed message authentication):

- Clear Key Request Retry timer;
- Process contents of Key Reply message and incorporate new keying material;
- Set the TEK Refresh timer to fire "TEK Grace Time" seconds prior to the key's scheduled expiration.

[Rekey Wait] + {Key Reply} --> [Op] (Key RejectReply passed message authentication):

- Clear Key Request Retry timer;
- Process contents of Key Reply message and incorporate new keying material;
- Set the TEK Refresh timer to fire "TEK Grace Time" seconds prior to the key's scheduled expiration.

[Op Wait] + {Key Reject} --> [Start] (Key RejectReply passed message authentication):

- Clear Key Request Retry timer;
- Terminate TEK FSM.

[Rekey Wait] + {Key Reject} --> [Start]:

- Clear Key Request Retry timer;
- Terminate TEK FSM;
- Remove SAID keying material.

7.2 Key Management Message Formats

Baseline Privacy Key Management employs two MAC message types: BPKM-REQ and BPKM-RSP. The CMTS MUST support the BPKM formats as defined in this section. The CM MUST support the BPKM formats as defined in this section. [DOCSIS MULPIv3.1] defines the specific type values assigned to these messages (see also Table 7-3).

Table 7-3 - Baseline Privacy Key Management MAC Messages

Type Value	Message Name	Message Description
See [DOCSIS MULPIv3.1]	BPKM-REQ	Privacy Key Management Request [CM → CMTS]
See [DOCSIS MULPIv3.1]	BPKM-RSP	Privacy Key Management Response [CMTS → CM]

7.2.1 Packet Formats

One BPKM message is encapsulated in the Management Message Payload field of a single MAC management message.

A summary of the BPKM message format follows. The CMTS MUST transmit fields and their respective contents from left to right. The CM MUST transmit fields and their respective contents from left to right.

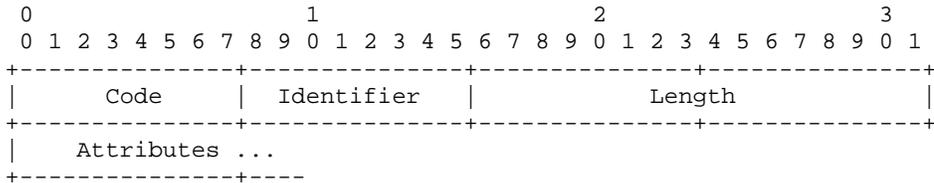

Code

The Code field is one octet, and identifies the type of BPKM packet. When a packet is received with an invalid Code field, it SHOULD be silently discarded.

BPKM Codes (decimal) are assigned as follows:

Table 7-4 - Baseline Privacy Key Management Message Codes

Code	BPKM Message Type	MAC Management Message Name
0-3	Reserved	-
4	Auth Request	BPKM-REQ
5	Auth Reply	BPKM-RSP
6	Auth Reject	BPKM-RSP
7	Key Request	BPKM-REQ
8	Key Reply	BPKM-RSP
9	Key Reject	BPKM-RSP
10	Auth Invalid	BPKM-RSP
11	TEK Invalid	BPKM-RSP
12	Auth Info	BPKM-REQ
13	Map Request	BPKM-REQ
14	Map Reply	BPKM-RSP
15	Map Reject	BPKM-RSP
16-255	Reserved	-

Identifier

The Identifier field is one octet. A CM uses this field to match a CMTS's responses to the CM's requests.

The CM MUST change the value of the Identifier field whenever it issues a new BPKM message. A "new" message is an Authorization Request, Key Request or SA Map Request that is not a retransmission being sent in response to a {Timeout} event. For retransmissions, the CM MUST keep the Identifier field unchanged from the value in the message being retransmitted.

The Identifier field in Authentication Information messages, which are informative and do not affect any response messaging, may be set to any value.

The CMTS MUST set the Identifier field of a BPKM response message to exactly match the Identifier field of the BPKM Request message to which the CMTS is responding. The CMTS MUST set the Identifier field in TEK Invalid messages, which are not sent in response to BPKM requests, to zero. The CMTS MUST set the Identifier field in unsolicited Authorization Invalid messages to zero.

On receipt of a BPKM response message, the CM MUST associate the message with a particular state machine (the Authorization state machine in the case of Authorization Replies, Authorization Rejects and Authorization Invalids; a particular TEK state machine in the case of Key Replies, Key Rejects and TEK Invalids, using the SAID attribute in the BPKM response message; a particular SA Mapping state machine in the case of SA Map Replies and SA Map Rejects⁶).

The CM MAY keep track of the Identifier of a pending Authorization Request. The CM MAY silently discard Authorization Replies and Authorization Rejects whose Identifier fields do not match those of pending requests.

The CM MAY keep track of the Identifier of a pending Key Request. The CM MAY silently discard Key Replies and Key Rejects whose Identifier fields do not match those of pending requests.

The CM MAY keep track of the Identifier of a pending SA Map Request. The CM MAY silently discard SA Map Replies and SA Map Rejects whose Identifier fields do not match those of pending requests.

Length

The Length field is two octets. It indicates the length of the Attribute fields, in octets. The value of the Length field does not include the length of the Code, Identifier and Length fields. If the packet contains more octets than indicated by the value of the Length field, the CMTS MUST ignore the additional octets. If the packet is shorter than indicated by the value of the Length field, the CMTS SHOULD silently discard it. If the packet contains more octets than indicated by the value of the Length field, the CM MUST ignore the additional octets. If the packet is shorter than indicated by the value of the Length field, the CM SHOULD silently discard it. The CMTS MUST set the value of the Length field to be in the range [0, 1490]. The CM MUST set the value of the Length field to be in the range [0, 1490].

Attributes

BPKM Attributes carry the specific authentication, authorization and key-management data exchanged between client and server. Each BPKM packet type has its own set of required and optional Attribute fields. Unless explicitly stated, there are no requirements on the ordering of Attribute fields in a BPKM message.

The position of the end of the Attribute fields is calculated from the value of the Length field.

Attribute fields are type/length/value (TLV) encoded:

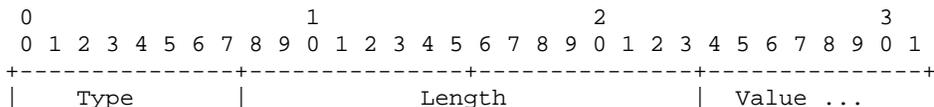

The BPKM MAC frame format is described in Section 6, and the BPKM packet format is described in Section 7.2.1. The descriptions below list the BPKM attributes contained in each BPKM message type. The Attribute fields themselves are described in Section 7.2.2. The CMTS MUST ignore unknown attributes on receipt. The CM MUST ignore unknown attributes on receipt.

⁶ The SA mapping mechanism was used in earlier versions of DOCSIS to support dynamic SAs (see Annex C).

The CMTS MUST discard all messages that do not contain all the required attributes with valid values. The CM MUST discard all messages that do not contain all the required attributes with valid values.

7.2.1.1 Authorization Request (Auth Request)

Code: 4

Attribute List:

Table 7-5 - Authorization Request Attributes

Attribute	Contents	See
CM-Identification	Contains information used to identify CM to CMTS	Section 7.2.2.5
CM-Certificate	Contains the CM's Device certificate	Section 7.2.2.18
Security-Capabilities	Describes the CM's security capabilities	Section 7.2.2.19
SAID	Initialization SAID or CM's Primary SAID	Section 7.2.2.12

The `CM-Identification` attribute contains data that identifies the CM to the CMTS. The public key in the `RSA-Public-Key` sub-attribute of the `CM-Identification` attribute is identical to the public key in the `CM-Certificate` attribute.

The `CM-Certificate` attribute contains a CM Device Certificate. The CM Device Certificate binds the CM's identifying information to its RSA public key. The certificate is signed by the CableLabs Device CA, and that signature can be verified by a CMTS that knows the corresponding public key.

The `Security-Capabilities` attribute is a compound attribute describing the CM's security capabilities: supported data encryption algorithms, data authentication algorithms, and versions of the DOCSIS Security protocol.⁷

A SAID attribute contains the value of a SAID. The SAID attribute contains the Initialization SAID (whose value is zero; see Section 7.1.1) if a CM is attempting initial Authorization, and a CM's primary SAID, if a CM is attempting reauthorization.

7.2.1.2 Authorization Reply (Auth Reply)

Sent by the CMTS to a client CM in response to an Authorization Request, the Authorization Reply message contains an Authorization Key, the key's lifetime, the key's sequence number, and a list of SA-Descriptors, identifying the Primary and Static Security Associations that the CM is authorized to access, along with their particular properties (i.e., type, cryptographic suite). The CMTS MUST encrypt the Authorization Key with the CM's public key. In the SA-Descriptor list, the CMTS MUST include a descriptor for the Primary SAID contained in the Authorization Request. In the SA-Descriptor list, the CMTS MAY include descriptors of Static SAIDs that the CM is authorized to access.

Code: 5

Attribute List:

Table 7-6 - Authorization Reply Attributes

Attribute	Contents	See
Auth-Key	Contains the Authorization Key, RSA encrypted with public key	Section 7.2.2.7
Key-Lifetime	Authorization Key remaining lifetime	Section 7.2.2.9
Key-Sequence-Number	Authorization Key sequence number	Section 7.2.2.10
SA-Descriptor (one or more)	Compound attribute containing SAID and other properties.	Section 7.2.2.23

⁷ Formerly known as the Baseline Privacy Protocol.

7.2.1.3 Authorization Reject (Auth Reject)

The CMTS responds to a CM's Authorization Request with an Authorization Reject message if the CMTS rejects the CM's authorization request.

Code: 6

Attribute List:

Table 7-7 - Auth Reject Attributes

Attribute	Contents	See
Error-Code	Error code identifying reason for rejection of Authorization Request	Section 7.2.2.15
Display-String (OPTIONAL)	Textual reason for rejection of authorization request	Section 7.2.2.6

The `Error-Code` and `Display-String` attributes describe the reason for the authorization failure.

7.2.1.4 Key Request

Code: 7

Attribute List:

Table 7-8 - Key Request Attributes

Attribute	Contents	See
CM-Identification	Contains information used to identify the CM to the CMTS	Section 7.2.2.5
Key-Sequence-Number	Authorization key sequence number	Section 7.2.2.10
SAID	Security Association ID	Section 7.2.2.12
HMAC-Digest	Keyed message digest	Section 7.2.2.11

The `HMAC-Digest` attribute is a keyed message digest. The CM MUST ensure that the `HMAC-Digest` attribute is the final attribute in the Key Request's Attribute list. The message digest is performed over the packet header and all the Key Request's Attribute fields, other than the `HMAC-Digest`, in the order in which they appear within the packet.

`HMAC-Digest`'s authentication key is derived from the Authorization Key (see Section 11.4 for details).

7.2.1.5 Key Reply

Code: 8

Attribute List:

Table 7-9 - Key Reply Attributes

Attribute	Contents	See
Key-Sequence-Number	Authorization key sequence number	Section 7.2.2.10
SAID	Security Association ID	Section 7.2.2.12
TEK-Parameters	"Older" generation of key parameters relevant to SAID	Section 7.2.2.13
TEK-Parameters	"Newer" generation of key parameters relevant to SAID	Section 7.2.2.13
HMAC-Digest	Keyed SHA message digest	Section 7.2.2.11

The `TEK-Parameters` attribute is a compound attribute containing all the keying material corresponding to a particular generation of a SAID's TEK: the TEK, the TEK's remaining key lifetime, its key sequence number, and the CBC initialization vector. The TEK is encrypted (see Section 11.2 for details).

The `HMAC-Digest` attribute is a keyed message digest. The CMTS MUST ensure that the `HMAC-Digest` attribute is the final attribute in the `Key Reply`'s Attribute list. The message digest is performed over the `BPKM` message header (starting with the `BPKM Code` field) and all of the `Key Reply`'s Attribute fields, other than the `HMAC-Digest`, in the order in which they appear within the packet.

`HMAC-Digest`'s authentication key is derived from the Authorization Key (see Section 11.4 for details).

7.2.1.6 Key Reject

Receipt of a `Key Reject` indicates that the recipient CM is no longer authorized to use a particular SAID.

Code: 9

Attribute List:

Table 7-10 - Key Reject Attributes

Attribute	Contents	See
Key-Sequence-Number	Authorization key sequence number	Section 7.2.2.10
SAID	Security Association ID	Section 7.2.2.12
Error-Code	Error code identifying reason for rejection of Key Request	Section 7.2.2.15
Display-String (OPTIONAL)	Display string containing reason for Key Reject	Section 7.2.2.6
HMAC-Digest	Keyed SHA message digest	Section 7.2.2.11

The `HMAC-Digest` attribute is a keyed message digest. The CMTS MUST ensure that the `HMAC-Digest` attribute is the final attribute in the `Key Reject`'s Attribute list. The message digest is performed over the `BPKM` message header (starting with the `BPKM Code` field) and all of the `Key Reject`'s Attribute fields, other than the `HMAC-Digest`, in the order in which they appear within the packet.

`HMAC-Digest`'s authentication key is derived from the Authorization Key (see Section 11.4 for details).

7.2.1.7 Authorization Invalid

The `Authorization Invalid` message instructs the receiving CM to re-authorize with its CMTS.

Code: 10

Attribute List:

Table 7-11 - Authorization Invalid Attributes

Attribute	Contents	See
Error-Code	Error code identifying reason for Authorization Invalid	Section 7.2.2.10
Display-String (OPTIONAL)	Textual description of failure condition	Section 7.2.2.6

7.2.1.8 TEK Invalid

The CMTS sends a `TEK Invalid` message to a client CM if the CMTS determines that the CM encrypted an upstream PDU with an invalid `TEK`: i.e., a SAID's `TEK` key sequence number, contained within the received packet's `Baseline Privacy Extended Header` element, is out of the CMTS's range of known, valid sequence numbers for that SAID.

Code: 11

Attribute List:

Table 7-12 - TEK Invalid Attributes

Attribute	Contents	See
Key-Sequence-Number	Authorization key sequence number	Section 7.2.2.10
SAID	Security Association ID	Section 7.2.2.12
Error-Code	Error code identifying reason for TEK Invalid message	Section 7.2.2.15
Display-String (OPTIONAL)	Textual vendor-defined information	Section 7.2.2.6
HMAC-Digest	Keyed SHA message digest	Section 7.2.2.11

The `HMAC-Digest` attribute is a keyed message digest. The CMTS MUST ensure that the `HMAC-Digest` attribute is the final attribute in the TEK Invalid's Attribute list. The message digest is performed over the BPKM message header (starting with the `BPKM Code` field) and all of the TEK Invalid's attribute fields, other than the `HMAC-Digest`, in the order in which they appear within the packet.

`HMAC-Digest`'s authentication key is derived from the Authorization Key (see Section 11.4 for details).

7.2.1.9 Authentication Information (Auth Info)

The Authentication Info message contains a single CA-Certificate Attribute field, which contains a legacy Manufacturer CA or Device CA Certificate. The CM's Device Certificate MUST have been issued by the certification authority identified by this certificate.

Authentication Information messages are usually informative: while the CM is required to transmit Auth Info messages as indicated by the Authentication state model (see Section 7.1.4), the CMTS under some circumstances may ignore them.

Code: 12

Attribute:

Table 7-13 - Authentication Information Attributes

Attribute	Contents	See
CA-Certificate	Certificate of the legacy Manufacturer CA or Device CA	Section 7.2.2.17 and Section 7.2.2.31

7.2.1.10 SA Map Request (MAP Request)⁸

A CM sends SA Map Requests to its CMTS to request the mapping of a particular downstream traffic flow to an SA. Annex C describes the SA Mapping state model.

Code: 13

Attribute List:

Table 7-14 - SA Map Request Attributes

Attribute	Contents	See
CM-Identification	Contains information used to identify the CM to the CMTS	Section 7.2.2.5
SA-Query	Contains addressing information identifying the downstream traffic flow for which the CM is requesting an SA mapping	Section 7.2.2.25

7.2.1.11 SA Map Reply (Map Reply)

A CMTS sends an SA Map Reply as a positive response to a client CM's SA Map Request. The SA Map Reply informs the CM of a mapping between a queried address and an SA. Annex C describes the SA Mapping state model.

⁸ The SA mapping mechanism was used in earlier versions of DOCSIS to support dynamic SAs (see Annex C).

Code: 14

Attribute List:

Table 7-15 - SA Map Reply Attributes

Attribute	Contents	See
SA-Query	Contains addressing information identifying the downstream traffic flow for which the CM is requested an SA mapping	Section 7.2.2.25
SA-Descriptor	Compound attribute containing the mapped SA's SAID and other properties	Section 7.2.2.23

7.2.1.12 SA Map Reject (Map Reject)

A CMTS sends an SA Map Reject as a negative response to a client CM's SA Map Request. The SA Map Reject informs the CM that either:

- Downstream traffic flow identified in the SA-Query attribute is not being encrypted; or
- The requesting CM is not authorized to receive that traffic.

The content of an error code attribute distinguishes between these two cases. Annex C describes the SA Mapping state model.

Code: 15

Attribute List:

Table 7-16 - SA MAP Reject Attributes

Attribute	Contents	See
SA-Query	Contains addressing information identifying the downstream traffic flow for which the CM requested an SA mapping	Section 7.2.2.25
Error-Code	Error code identifying reason for rejection of the SA Map Request	Section 7.2.2.15
Display-String (OPTIONAL)	Textual reason for the SA Map Reject	Section 7.2.2.6

7.2.2 BPKM Attributes

A summary of the format of the Attribute field is:

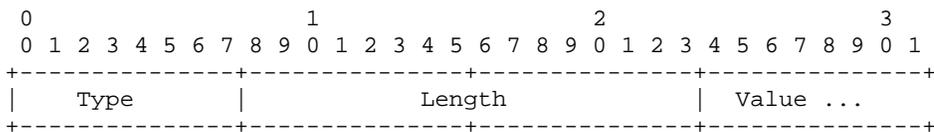

Type

The Type field is one octet. Values of the BPKM Type field are specified below. Values between 0 and 127 inclusive are defined within this specification; values between 128 and 255 are vendor-assigned Attribute Types.

The CMTS MUST ignore attributes with an unknown value of Type field. The CMTS MAY log receipt of attributes with unknown values of the Type field.

The CM MUST ignore attributes with an unknown value of Type field. The CM MAY log receipt of attributes with unknown values of the Type field.

Some BPKM attributes are also used for the Secure Software Download code file (see Section 14).

Table 7-17 - BPKM Attribute Types

Type	BPKM Attribute
0	Reserved
1	Serial-Number
2	Manufacturer-ID
3	MAC-Address
4	RSA-Public-Key (also used for secure software download, see Section 14)
5	CM-Identification
6	Display-String
7	Auth-Key
8	TEK
9	Key-Lifetime
10	Key-Sequence-Number
11	HMAC-Digest
12	SAID
13	TEK-Parameters
14	Reserved
15	CBC-IV
16	Error-Code
17	CA-Certificate (also used for secure software download, see Section 14)
18	CM-Certificate
19	Security-Capabilities
20	Cryptographic-Suite
21	Cryptographic-Suite-List
22	BPI-Version
23	SA-Descriptor
24	SA-Type
25	SA-Query
26	SA-Query-Type
27	IPv4-Address
28	Download-Parameters (used for secure software download, (see Section 14)
51	CVC-Root-CA-Certificate (used for secure software download, (see Section 14)
52	CVC-CA-Certificate (used for secure software download, (see Section 14)
53	Device-CA-Certificate (used for secure software download, (see Section 14)
54	Root-CA-Certificate (used for secure software download, (see Section 14)
29-50, 53-126	Reserved
127	Vendor-Defined
128-255	Vendor-assigned attribute types

Length

The Length field is two octets, and indicates the length of this attribute's Value field, in octets. The value of the Length field does not include the length of the Type and Length fields. The CMTS MUST set the value of the Length field to be in the range [0, 1487]. The CM MUST set the value of the Length field to be in the range [0, 1487].

The CMTS SHOULD silently discard packets containing attributes with invalid values of the Length field. The CM SHOULD silently discard packets containing attributes with invalid values of the Length field.

Value

The Value field is zero or more octets and contains information specific to the particular attribute. The format and length of the Value field is determined by the contents of the Type and Length fields. All multi-octet integer quantities are in network order, i.e., the octet containing the most-significant bits is the first transmitted on the wire.

The format of the Value field is one of five data types, as shown in Table 7-18.

Table 7-18 - Attribute Value Data Types

Type	Meaning
string	0 – 1487 octets
uint8	8-bit unsigned integer
uint16	16-bit unsigned integer
uint32	32-bit unsigned integer
compound	collection of attributes

7.2.2.1 Serial-Number

This attribute contains the serial identifier assigned by the manufacturer to a CM.

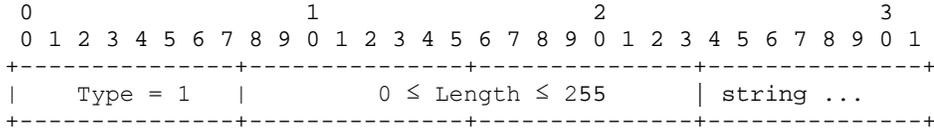

string

The string field is zero or more octets and contains a serial identifier assigned by the manufacturer.

The CM MUST encode the serial identifier in the [ISO 8859-1] character-set encoding. The CM MUST use only the following characters:

- Upper case letters, A to Z (0x41-0x5A)
- Lower case letters, a to z (0x61-0x7A)
- Digits, 0 to 9 (0x30-0x39)
- Dash, - (0xD2)

7.2.2.2 Manufacturer-ID

This attribute identifies the manufacturer. The identifier is 3 octets long and contains the 24-bit Organizationally Unique Identifier (OUI) assigned to applying organizations by the IEEE.

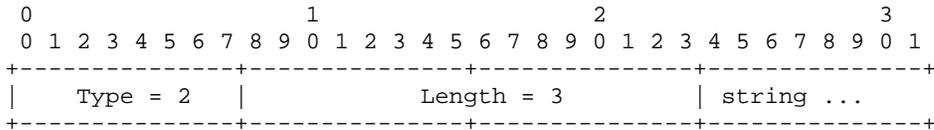

string

The string field is three octets in length and contains an IEEE OUI.

7.2.2.3 MAC-Address

This attribute identifies the MAC address assigned to the CM.

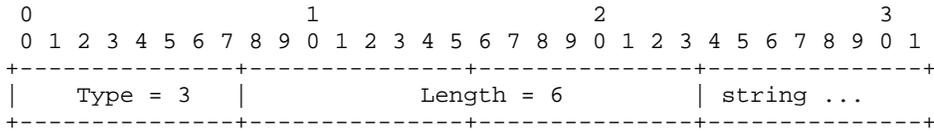

string

The string field contains a 6-octet MAC address.

7.2.2.4 RSA-Public-Key

This attribute is a string attribute containing a DER-encoded RSAPublicKey ASN.1 type, as defined in [X.509]:

```
RSAPublicKey ::= SEQUENCE {
    modulus INTEGER,
    publicExponent INTEGER }
```

The CMTS MUST support a publicExponent of F_4 . The CM MUST support a publicExponent of F_4 .

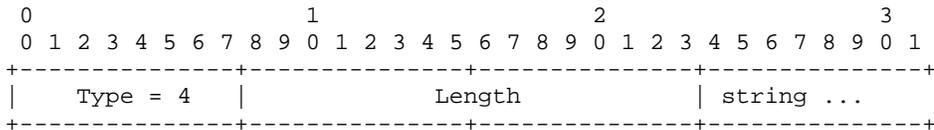

Length

The length specified is 106, 140, or 270 octets (length of DER-encoded RSAPublicKey, using F_4 as the public exponent and a 768-bit, 1024-bit, or 2048-bit public modulus respectively).

string

DER-encoded RSAPublicKey

7.2.2.5 CM-Identification

This is a compound attribute, consisting of a collection of sub-attributes. These sub-attributes contain information that can be used to uniquely identify a CM. The CM MUST provide the following sub-attributes:

- Serial-Number
- Manufacturer-ID
- MAC-Address
- RSA-Public-Key

CM-Identification MAY also contain optional Vendor-Defined Attributes.

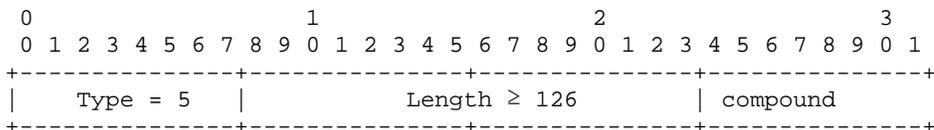

7.2.2.6 Display-String

This attribute contains a textual message. It is typically used to explain a failure response, and might be logged by the receiver for later retrieval by an SNMP manager. The CMTS MUST NOT use display strings longer than 128 octets. The CM MUST NOT use display strings longer than 128 octets. This specification does not define the character set nor the language to be used in the Display-String attribute.

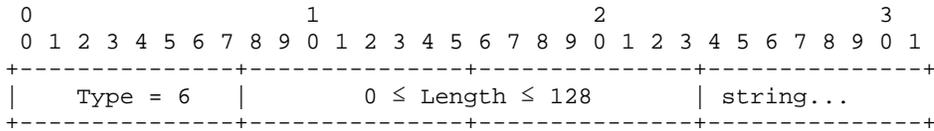

string

A string of octets

7.2.2.7 Auth-Key

The Authorization Key is a twenty (20)-octet value, from which other keys are derived.

This attribute contains either a ninety-six (96)-, one-hundred twenty-eight (128)-, or a two-hundred fifty-six(256)-octet value that is the Authorization Key encrypted with the CM's 768-bit, 1024-bit, or 2048-bit RSA public key. Details of the RSA encryption procedure are given in Section 11.5.

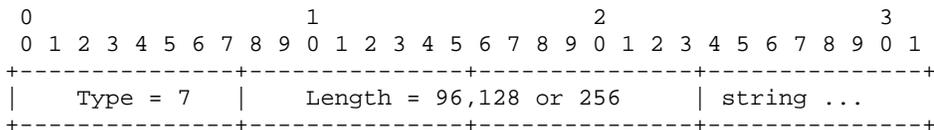

string

Encrypted Authorization Key

7.2.2.8 TEK

This attribute contains a TEK encrypted with a KEK derived from the Authorization Key. TEKs are encrypted using the Encrypt-Decrypt-Encrypt (EDE) mode of two-key 3DES (see Section 11.2 for details).

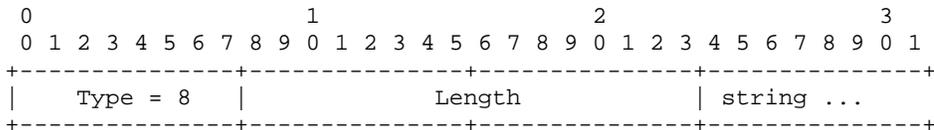

Length

Eight (8) (DES TEK) or sixteen (16) (AES TEK)

string

Encrypted Traffic Encryption Key

7.2.2.9 Key-Lifetime

This attribute contains the lifetime, in seconds, of an Authorization Key or TEK. It is a thirty-two (32)-bit unsigned quantity representing the remaining number of seconds for which the associated key is valid.

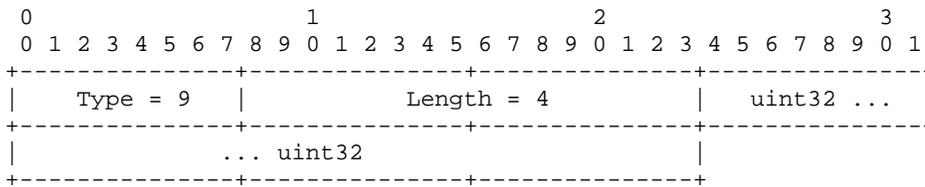

uint32

Remaining key lifetime, in seconds

A key lifetime of zero indicates that the corresponding key is not valid.

7.2.2.10 Key-Sequence-Number

This attribute contains a 4-bit sequence number for a TEK or Authorization Key. The four (4)-bit quantity is stored in an octet. The CMTS MUST set the high-order four (4) bits to zero (0). The CM MUST set the high-order four (4) bits to zero (0).

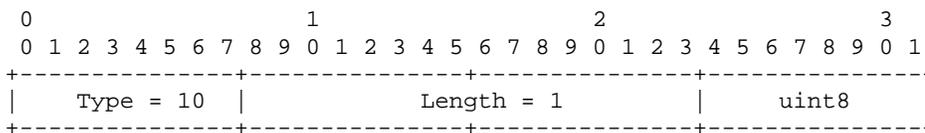

uint8

4-bit sequence number

7.2.2.11 HMAC-Digest

This attribute contains a keyed hash, used for message authentication. The HMAC algorithm is defined in [RFC 2104]; the hash algorithm is SHA-1 [FIPS 180-4].

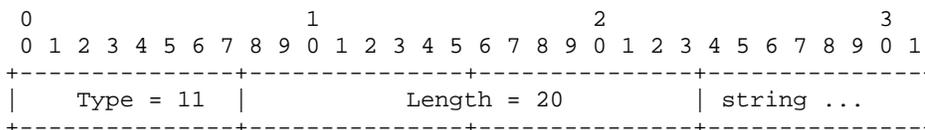

string

A 160-bit (20-octet) keyed SHA-1 hash

7.2.2.12 SAID

This attribute contains a fourteen (14)-bit Security Association ID (SAID). The CMTS MUST set the two high-order bits to zero. The CM MUST set the two high-order bits to zero.

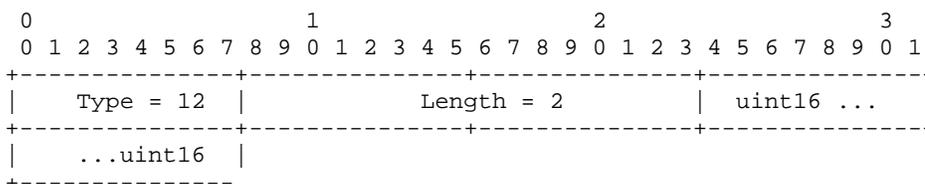

uint16

SAID

7.2.2.13 TEK-Parameters

This is a compound attribute, consisting of a collection of sub-attributes. These sub-attributes represent all the security parameters relevant to a particular generation of a SAID's TEK.

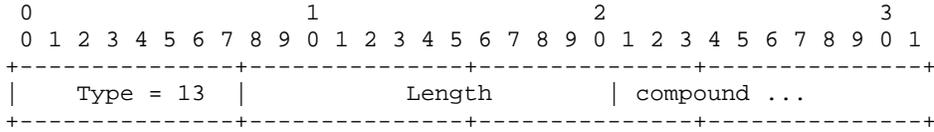

Length

Thirty-three (33) (DES) or Forty-Nine (49) (AES)

compound

This field contains the following sub-attributes:

Table 7-19 - TEK-Parameters Sub-Attributes

Attribute	Contents	See
TEK	TEK, encrypted (two-key 3DES-EDE mode) with the KEK	Section 7.2.2.8
Key-Lifetime	TEK Remaining Lifetime	Section 7.2.2.9
Key-Sequence-Number	TEK Sequence Number	Section 7.2.2.10
CBC-IV	Cipher Block Chaining (CBC) Initialization Vector	Section 7.2.2.14

7.2.2.14 CBC-IV

This attribute contains a Cipher Block Chaining (CBC) Initialization Vector.

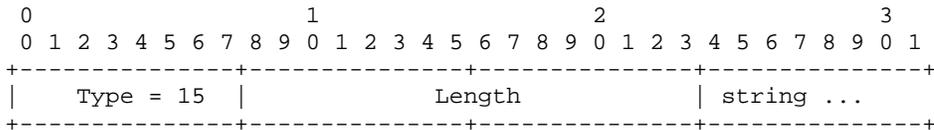

Length

Eight (8) (DES) or sixteen (16) (AES)

string

Initialization Vector

7.2.2.15 Error-Code

This attribute contains a one-octet error code that provides further information about an Authorization Reject, Key Reject, Authorization Invalid, SA-MAP Reject⁹ or TEK Invalid message.

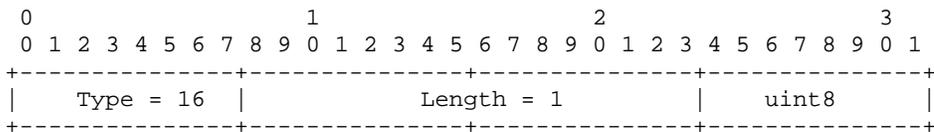

⁹ The SA mapping mechanism was used in earlier versions of DOCSIS to support dynamic SAs (see Annex C).

uint8

1-octet error code

The CMTS MUST include the Error-Code Attribute in all Authorization Reject, Authorization Invalid, Key Reject, TEK Invalid and SA-MAP Reject messages. Table 7-20 lists code values for use with this Attribute. The CMTS MUST employ the non-zero error codes listed in the table for SA-MAP Reject messages. The CMTS MUST employ error codes listed in the table (including zero) for the other message types. The CM MUST ignore error code values other than those defined in Table 7-20.

Table 7-20 - Error-Code Attribute Code Values

Error Code	Messages	Description
0	All	No Information
1	Auth Reject, Auth Invalid	Unauthorized CM
2	Auth Reject, Key Reject	Unauthorized SAID
3	Auth Invalid	Unsolicited
4	Auth Invalid, TEK Invalid	Invalid Key Sequence Number
5	Auth Invalid	Message (Key Request) authentication failure
6	Auth Reject	Permanent Authorization Failure
7	Map Reject	Not authorized for requested downstream traffic flow
8	Map Reject	Downstream traffic flow not mapped to SAID
9	Auth Reject	Time of day not acquired
10	Auth Reject	EAE Disabled

Error code 6, Permanent Authorization Failure, is used to indicate a number of different error conditions affecting the BPKM authorization exchange. These include:

- An unknown manufacturer; i.e., the CMTS does not have the CA certificate belonging to the issuer of a CM Device Certificate;
- CM Device Certificate has an invalid signature;
- ASN.1 parsing failure during verification of CM Device Certificate;
- CM Device Certificate is revoked (see Section 13.4);
- Inconsistencies between certificate data and data in accompanying BPKM attributes;
- CM and CMTS have incompatible security capabilities.

The CMTS MUST send an Authorization Reject message containing error code 6 (Permanent Authorization Failure) in response to an Authorization Request message when any of the following occurs:

- The CMTS fails to validate the CM Device Certificates per Section 13.3.2;
- The CM and the CMTS have incompatible security capabilities (see Section 7.2.1.1).

Entries in the CMTS MIB (see [DOCSIS CM-OSSIV3.1]) control the actions that a CMTS takes in the event that any of the above error conditions occur.

The CMTS MAY report details about the cause of a Permanent Authorization Failure to the CM in an optional Display-String Attribute that may accompany the Error-Code Attribute in Authorization Reject messages. The CMTS SHOULD provide the capability to control administratively whether additional detail is sent to the CM. The CMTS MAY log these Authorization failures or otherwise make them known to the operator.

7.2.2.16 Vendor-Defined

The Vendor-Defined attribute is a compound attribute whose first sub-attribute is the Manufacturer-ID. Subsequent attribute(s) are defined by the manufacturer, with Type values assigned by the vendor identified by the Manufacturer-ID.

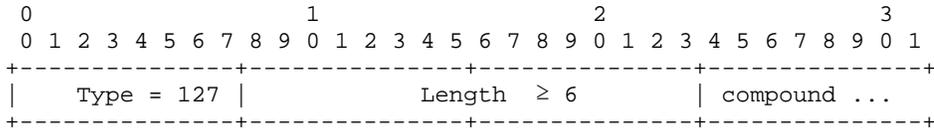

compound

The CMTS MUST insert the Manufacturer-ID as the first sub-attribute. The CM MUST insert the Manufacturer-ID as the first sub-attribute. Subsequent attributes can include both Types defined within this specification and vendor-defined Types, defined by the vendor identified in the preceding Manufacturer-ID sub-attribute.

7.2.2.17 CA-Certificate

This attribute contains a DER-encoded legacy Manufacturer CA or Device CA certificate.

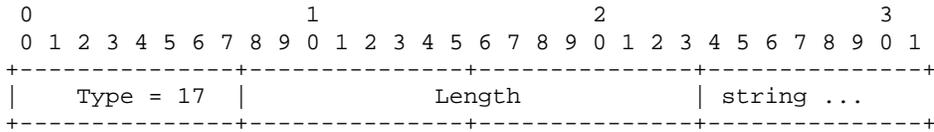

Length

Variable

string

DER-encoded Manufacturer CA or CableLabs Mfg CA certificate

7.2.2.18 CM-Certificate

This attribute contains the DER-encoded CM Device Certificate.

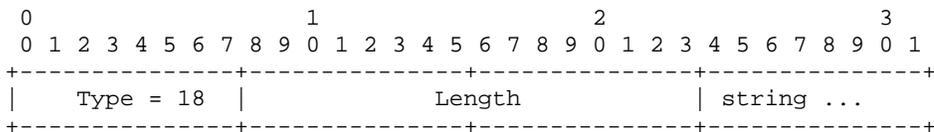

Length

Variable

string

DER-encoded CM Device Certificate

7.2.2.19 Security-Capabilities

This is a compound attribute whose sub-attributes identify the version of DOCSIS Security and the cryptographic suite(s) supported by a CM.

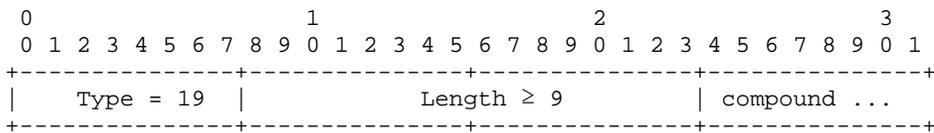

compound

This field contains the following sub-attributes:

Table 7-21 - Security-Capabilities Sub-Attributes

Attribute	Contents	See
Cryptographic-Suite-List	list of supported cryptographic suites	7.2.2.21
BPI-Version	version of BPI+ supported	7.2.2.22

7.2.2.20 Cryptographic-Suite

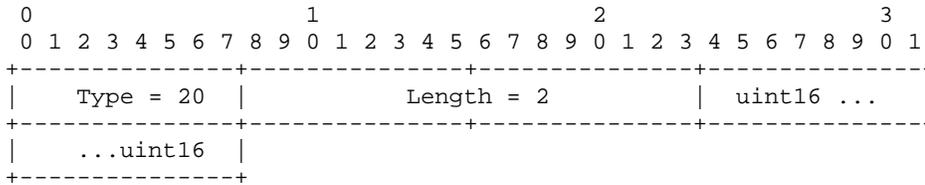

uint16

A 16-bit integer identifying a pairing of a data encryption algorithm (encoded in the most significant octet) taken from Table 7-22 and a data authentication algorithm (encoded in the least significant octet) taken from Table 7-23. The CMTS MUST use a value that appears in Table 7-24 The CM MUST use a value that appears in Table 7-24.

Table 7-22 - Data Encryption Algorithm Identifiers

Value	Description
0	Reserved
1	CBC-Mode, 56-bit DES
2	CBC-Mode, 40-bit DES
3	CBC-Mode, 128-bit block, 128-bit key AES
4-255	Reserved

Table 7-23 - Data Authentication Algorithm Identifiers

Value	Description
0	No data authentication
1-255	Reserved

Table 7-24 - Cryptographic-Suite Attribute Values

Value	Description
256 (0x0100)	CBC-Mode 56-bit DES, no data authentication
512 (0x0200)	CBC-Mode 40-bit DES, no data authentication
768 (0x0300)	CBC-Mode 128-bit AES, no data authentication
All remaining values	Reserved

7.2.2.21 Cryptographic-Suite-List

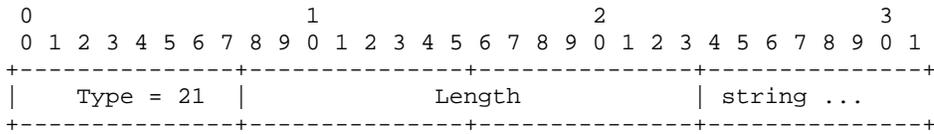

Length

$2 \times n$, where n is the number of cryptographic suites in the list

string

A list of byte pairs identifying a collection of cryptographic suites. Each byte pair represents a supported cryptographic suite, with an encoding identical to the value field of the Cryptographic-Suite Attribute (Section 7.2.2.20). The CMTS MUST NOT interpret the relative ordering of byte pairs in the list as a CM's preferences amongst the cryptographic suites it supports.

7.2.2.22 BPI-Version

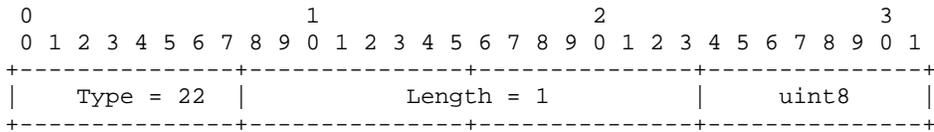

uint8

A one (1)-octet code identifying a version of Baseline Privacy security.

Table 7-25 - BPI-Version Attribute Values

Value	Description
0	Reserved
1	BPI+(security as defined in this specification)
2-255	Reserved

7.2.2.23 SA-Descriptor

This is a compound attribute whose sub-attributes describe the properties of a Security Association. These properties are: the SAID, the SA type, and the cryptographic suite employed by the SA.

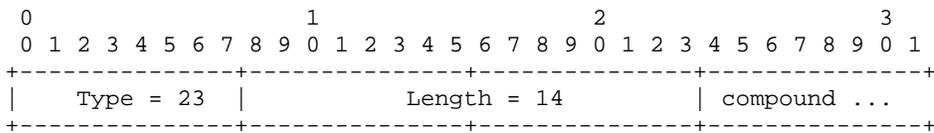

compound

This field contains the sub-attributes shown in Table 7-26.

Table 7-26 - SA-Descriptor Sub-Attributes

Attribute	Contents	See
SAID	Security Association ID	7.2.2.12
SA-Type	Type of SA	7.2.2.24
Cryptographic-Suite	Pairing of data encryption and data authentication algorithms employed within the SA	7.2.2.20

7.2.2.24 SA-Type

Identifies the type of SA. This specification defines three types of SA: Primary, Static, and Dynamic.

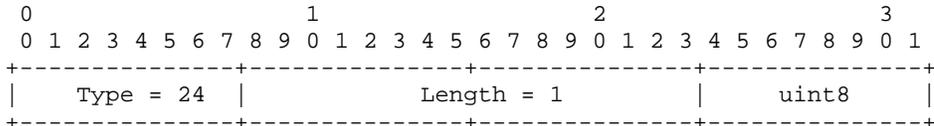

uint8

A 1-octet code identifying the value of SA-type as defined in Table 7-27.

Table 7-27 - SA-Type Attribute Values

Value	Description
0	Primary
1	Static
2	Dynamic
3-255	Reserved

7.2.2.25 SA-Query¹⁰

This compound attribute is used in SA Map Request messages to pass mapping query arguments. Query arguments include the query type and any addressing attributes particular to that query type. The addressing attributes identify a particular downstream traffic flow for which an SA mapping is being requested.

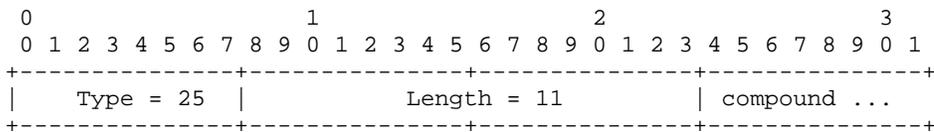

compound

This field contains the sub-attributes in Table 7-28.

Table 7-28 - SA-Query Sub-Attributes

Attribute	Contents	See
SA-Query-Type	Type of Query	7.2.2.26
IPv4-Address	Required if SA-Query-Type = IP-Multicast; contains an IPv4 group address whose SA mapping is being requested.	7.2.2.27

¹⁰ The SA mapping mechanism was used in earlier versions of DOCSIS to support dynamic SAs (see Annex C).

7.2.2.26 SA-Query-Type

Identifies the type of query. This specification defines two types of SA Queries: IP Multicast and Vendor Specific.

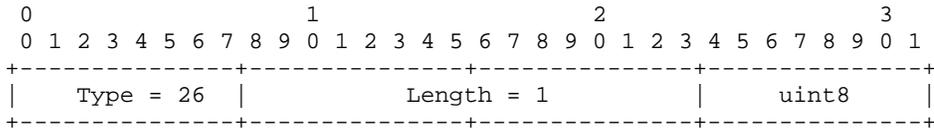

uint8

A 1-octet code identifying the value of SA-Query-Type as defined in Table 7-29.

Table 7-29 - SA-Query-Type Attribute Values

Value	Description
0	Reserved
1	IP Multicast
2-127	Reserved
128-255	Vendor Specific

7.2.2.27 IPv4-Address

This attribute identifies an IPv4 address that is used to identify an encrypted IP traffic flow. It is used, for example, to specify an IPv4 multicast group address.

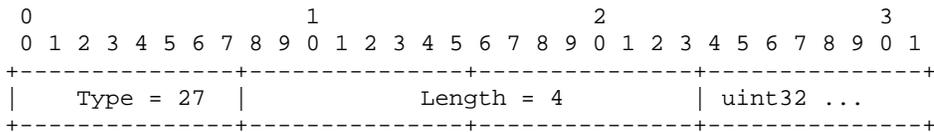

uint32

Contains a thirty-two (32)-bit unsigned integer (in network order) representing an IPv4 address.

7.2.2.28 Download-Parameters

This attribute is used in the CM Code File defined in Section 14. This is a compound attribute, consisting of an ordered collection of sub-attributes.

The sub-attributes include zero or more of the following attribute(s) in this order:

Legacy PKI Attributes

- Zero or one instances of RSA-Public-Key (see Section 7.2.2.4);
- Zero, one or more instances of CA-Certificate (see Section 7.2.2.17);
- Zero or one instance of CVC-Root-CA-Certificate, which is deprecated (see Section 7.2.2.29);
- Zero or one instance of CVC-CA-Certificate, which is deprecated (see Section 7.2.2.30).

New PKI Attributes

- Zero or one instance of Device-CA-Certificate (see Section 7.2.2.31);
- Zero or one instance of Root-CA-Certificate (see Section 7.2.2.32).

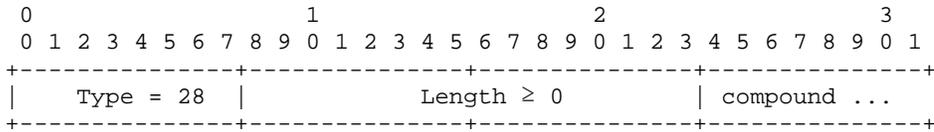

7.2.2.29 CVC-Root-CA-Certificate (deprecated)

This attribute contains a DER-encoded CVC Root CA certificate from the legacy PKI.

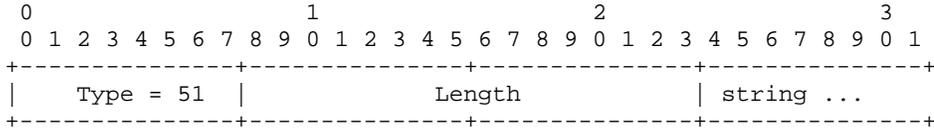

Length

Variable

string

DER-encoded CVC Root CA Certificate

7.2.2.30 CVC-CA-Certificate (deprecated)

This attribute contains a DER-encoded CVC CA certificate from the legacy PKI.

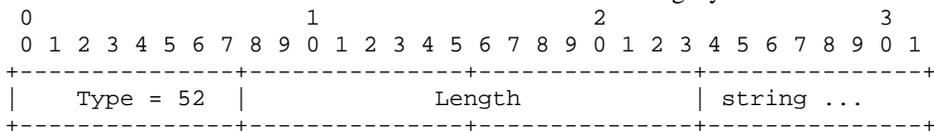

Length

Variable

string

DER-encoded CVC CA Certificate

7.2.2.31 Device-CA-Certificate

This attribute contains a DER-encoded Device CA Certificate from the new PKI.

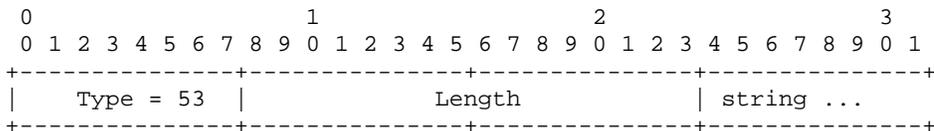

Length

Variable

string

DER-encoded Device CA Certificate from the new PKI

7.2.2.32 Root-CA-Certificate

This attribute contains a DER-encoded Root CA Certificate from the new PKI.

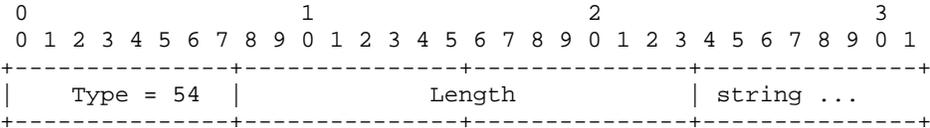

Length

Variable

string

DER-encoded Root CA Certificate from the new PKI

8 EARLY AUTHENTICATION AND ENCRYPTION (EAE)

8.1 Introduction

The process of CM initialization is described in [DOCSIS MULPIv3.1]. This section specifies requirements on the CM and the CMTS for securing the CM initialization process. This specification introduces early authentication and encryption (EAE) to DOCSIS CM initialization, and places the CMTS in charge of the authentication process on a modem-by-modem basis.

Early authentication functions as a network admission control; only authenticated CMs are allowed to continue their initialization process and may be subsequently admitted to the network. The results of a successful authentication are used for securing subsequent steps in the CM's initialization process.

Early Authentication and Encryption (EAE) refers to the following sequence of processes in their entirety:

1. The authentication of the CM (i.e., the BPI+ Authorization exchanges) following the completion of ranging and before DHCP exchanges (i.e., early authentication);
2. TEK key exchanges for the CM's Primary SAID;
3. Encryption of IP provisioning traffic and the REG-REQ-MP MAC message during CM initialization.

The CMTS **MUST** support EAE.

The CM **MUST** support EAE.

8.2 EAE Signaling

The CMTS uses TLV type 6 in the MDD MAC message to signal EAE to CMs. The CM determines whether it is required to perform EAE by detecting the MDD MAC message and inspecting TLV type 6.

When the CMTS is configured to enable EAE (see Section 8.4), the CMTS **MUST** include TLV type 6 in the MDD with its value set to 1 to signal to CMs that they are to perform EAE. When the CMTS is configured to disable EAE, the CMTS **MUST** include TLV type 6 in the MDD with its value set to 0, to signal to CMs that they do not perform EAE.

If the CM detects a valid MDD message before or during initial ranging, and the MDD contains TLV type 6 with a nonzero value, then the CM **MUST** start EAE by sending a {Initiate Authentication} event to the BPI+ Auth State Machine (see Section 7) immediately following Ranging completion. If the CM detects no MDD message before or during initial ranging, or the detected MDD message contains no TLV type 6, or the detected MDD contains TLV type 6 with value set to zero (0), then the CM **MUST NOT** start EAE. The CM follows procedures specified in [DOCSIS MULPIv3.1] to detect MDD.

The CMTS may omit MDD messages on some downstream channels. EAE only applies to CMs initializing on downstream channels that broadcast the MDD message.

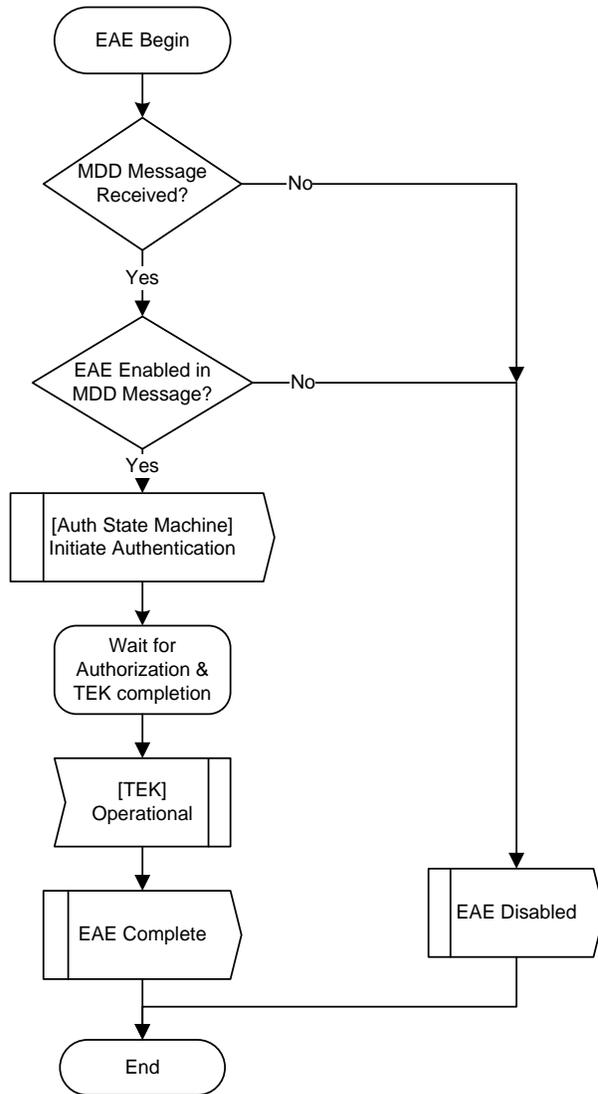

Figure 8-1 - EAE Signaling Flow Chart for CM

8.3 EAE Encryption

Once a CM has completed EAE Authorization, the CMTS MUST transmit all subsequent unicast DOCSIS data PDUs to that CM that are not otherwise assigned to a Security Association (SA) on the CM's primary SA, until such time BPI+ is disabled.

A CM which has completed EAE Authorization with a CMTS MUST transmit the following upstream traffic to the CMTS on the CM's primary Security Association:

- All data PDUs, including DHCP, TOD, and TFTP provisioning traffic; and
- The Registration Request (REG-REQ-MP) MAC management message.

An initializing CM does not encrypt other upstream MAC Management messages to the CMTS (see Section 6.5).

For the purposes of supporting IPv6 managed devices, this specification requires that multicast traffic addressed to the Well-known IPv6 Addresses (see [DOCSIS MULPIv3.1]) be exempted from EAE enforcement. As such, the CMTS MUST NOT encrypt multicast traffic addressed to these Well-known IPv6 Addresses.

8.4 EAE Enforcement

When EAE is enabled, the CMTS uses EAE to perform network admission control by forcing CMs to authenticate before allowing them to proceed with the initialization process. As a result of EAE, a security association is established for the CM's primary SAID, which protects subsequent provisioning messages (see [DOCSIS MULPIv3.1]).

The CMTS enforces EAE only for CMs that initialize on a downstream channel on which the CMTS is transmitting MDD messages. The CMTS MUST support the following configurable EAE enforcement policies:

Policy 1: No EAE enforcement, i.e., EAE is disabled, and the CMTS does not enforce EAE on any CM.

Policy 2: Ranging-Based EAE Enforcement, i.e., the CMTS enforces EAE on CMs that range with a B-INIT-RNG-REQ MAC message.

Policy 3: Capability-Based EAE Enforcement, i.e., the CMTS enforces EAE on CMs that range with a B-INIT-RNG-REQ MAC message in which the EAE capability flag is set.

Policy 4: Total EAE Enforcement, i.e., the CMTS enforces EAE on all CMs.

The EAE enforcement policies are mutually exclusive. By default, the CMTS MUST enable Ranging-Based EAE Enforcement (Policy 2). Policies 2 and 3 are referred to as Selective EAE Enforcement.

When configured for Selective EAE Enforcement the CMTS does not enforce EAE for DOCSIS 1.0/1.1/2.0 CMs since they do not support the B-INIT-RNG-REQ MAC message.

The CMTS enforces EAE on CMs based on the configured EAE enforcement policies. CMs in the EAE Exclusion List (see Section 8.4.5), are always exempted from EAE enforcement.

8.4.1 CMTS and CM Behaviors when EAE is Enabled

When EAE is enabled on a CMTS and a CM performs EAE, the following procedures need to be performed.

- When the ranging process has been successfully completed, the CMTS MUST drop all PDUs (i.e., frames with FC type 00) (see [DOCSIS MULPIv3.1]) from the CM until it has successfully completed EAE. A CM completes EAE when it has received the Key Reply message for the Primary SAID.
- The CMTS MUST use the Primary SA to carry all IP messages involved in the provisioning of the CM (i.e., DHCP, TOD, and TFTP).
- The CM MUST use the Primary SA to carry all IP messages involved in the provisioning of the CM (i.e., DHCP, TOD, and TFTP), and its REG-REQ-MP MAC messages.

8.4.2 EAE Enforcement Determination

This section describes how the CMTS makes EAE enforcement decisions based on its configured policy.

8.4.2.1 Ranging-Based EAE Enforcement

When the CMTS is configured to enable Ranging-Based EAE Enforcement (policy 2), the CMTS enforces EAE on a CM based on the CM's ranging MAC message type, ignoring the EAE capability flag in the B-INIT-RNG-REQ. When the CMTS is configured for EAE enforcement policy 2, it MUST enforce EAE only on CMs that range with B-INIT-RNG-REQ, except for CMs on the EAE Exclusion List (see Section 8.4.5).

8.4.2.2 Capability-Based EAE Enforcement

When the CMTS is configured to enable Capability-Based EAE Enforcement (policy 3), the CMTS enforces EAE on a CM based on its ranging MAC message type as well as the EAE capability flag in the B-INIT-RNG-REQ. When the CMTS is configured for policy 3 enforcement, it **MUST** enforce EAE only on CMs that range with B-INIT-RNG-REQ in which the EAE capability flag is set, except for CMs on the EAE Exclusion List (see Section 8.4.4).

8.4.2.3 Total EAE Enforcement

When the CMTS is configured to enable Total EAE Enforcement (policy 4), the CMTS **MUST** enforce EAE on all CMs, except for CMs on the EAE Exclusion List (see Section 8.4.4).

8.4.3 EAE Enforcement of DHCP Traffic

When the CMTS is configured to enable EAE with policy 2 or 3 enforcement the CMTS **MUST** discard DHCP packets from a CM if:

- The Vendor Class Identifier Option (option 60 for DHCPv4 and option 16 for DHCPv6) in the DHCP packets advertise DOCSIS version 3.0 or later (see [DOCSIS MULPIv3.1]); and
- The CM has not successfully completed EAE; and
- The CM is not on the EAE Exclusion List (see Section 8.4.5).

8.4.4 CMTS and CM Behavior when EAE is Disabled

When EAE is disabled, the following procedures need to be performed.

- The CMTS **MUST** allow a CM to proceed with the Initialization process (see [DOCSIS MULPIv3.1]) without performing EAE;
- The CM **MUST NOT** initiate EAE after completing initial ranging;
- After completing initial ranging the CM **MUST** proceed to the next step in the CM initialization process as defined in [DOCSIS MULPIv3.1];
- If the CMTS receives an Authorization Request from a CM following ranging completion, the CMTS **SHOULD NOT** perform authentication on the CM. The CMTS **MUST** respond to the Authorization Request with an Authorization Reject message containing the error code 10.

8.4.5 EAE Exclusion List

The CMTS **MUST** support the capability to exclude individual CMs from EAE enforcement based on their MAC addresses when policy 2, 3, or 4 is enabled on a per-MAC domain basis.

If a CM is on the exclusion list, the following procedures need to be performed:

- The CMTS **MUST** allow the CM to proceed with the Initialization process (see [DOCSIS MULPIv3.1]) without performing EAE.
- If the CMTS receives an Authorization Request from the CM following ranging completion, the CMTS **MUST** respond with an Authorization Reject message containing the error code 10.
- If the CM sends an Authorization Request immediately after ranging completion and receives error code 10 in the Authorization Reject message in response, the CM **MUST** terminate its Authorization state machine and proceed to the next step in its initialization process as described in [DOCSIS MULPIv3.1]. The CM will later initiate Authorization and subsequent TEK key exchanges if it receives a configuration file that enables BPI+ (see Section 7).

8.4.6 Interoperability Issues

A pre-DOCSIS 3.0 CM does not recognize the MDD message and thus will not attempt to perform EAE. The DOCSIS 3.0 CMTS MUST support initialization of pre-DOCSIS 3.0 CMs including operation of the Authorization and TEK state machines following registration as defined in [DOCSIS RFIv2.0].

A DOCSIS 3.0 CM capable of EAE, when deployed against a pre-DOCSIS 3.0 CMTS, determines that EAE is disabled because it does not receive a valid MDD during initial ranging. The process by which a CM detects a valid MDD during initial ranging is described in [DOCSIS MULPIv3.1]. A CM that fails to detect an MDD message proceeds directly to the "Establish IP Connectivity" phase after initial ranging.

8.5 Authentication Reuse

When EAE is enabled, CMs are authenticated immediately following successful ranging. This is early in a CM's initialization process, so a successful authentication can be used to eliminate authentication in subsequent steps during initialization. EAE is also used to secure DHCP, TOD, TFTP, and Registration over the cable network link (see Section 8.3 for more details).

8.6 BPI+ Control by Configuration File

If EAE is enabled for a CM, the CM performs early authentication and establishes its Authorization and TEK state machine for the primary SAID before receiving its configuration file. If EAE is disabled, the CM receives its configuration file before it is authenticated. In either case, the BPI+ setting in the configuration file (see [DOCSIS MULPIv3.1]) controls all subsequent privacy operations.

8.6.1 EAE Enabled

If EAE is enabled for a CM, its Authorization state machine and the TEK state machine for its Primary SAID are operational by the time the CM receives its configuration file. Depending on the BPI+ settings in the configuration file, the CM's security state machines may continue to operate or may be terminated when the configuration file is processed by the CM.

If the configuration file does not disable BPI+, then the CM's Authorization state machine and its TEK state machine for the Primary SAID MUST continue to operate. If the configuration file enables BPI+ but contains BPI+ settings that differ from the default values listed in Table A-1, then the CM MUST update its Auth and TEK state machines with any changed values it receives in the configuration file.

If the Authorization Grace Time value changes, the CM MUST Re-Authenticate after registration messaging is complete. If the TEK Grace Time value changes, the CM MUST perform a TEK Refresh after registration messaging is complete. If the configuration file contains BG_CFG subtype 3 (Authorization Grace Time, see Annex A) and its value is greater than half the remaining Authorization lifetime, then the CM MUST immediately set the Authorization Grace Time to 1 second less than half the remaining Authorization lifetime. If the configuration file does not contain BPI+ settings, or BPI+ settings are present and have default values listed in Table A-1, then the CM's state machines MUST continue to operate as normal EAE (see Annex A.2).

If EAE is enabled for a CM and its configuration file explicitly disables BPI+, then the CM MUST terminate its Authorization state machine and its TEK state machine for the Primary SAID as soon as registration is complete.

8.6.2 EAE Disabled

If EAE is disabled for a CM, then the CM does not initiate any security exchanges with the CMTS until after Registration. The CM's configuration file controls completely whether it initiates any security exchanges with the CMTS.

If EAE is disabled and the CM's configuration file enables BPI+ the following procedures need to be performed:

- The CM MUST send an {Initiate Authentication} event to the Authorization State Machine (see Section 7.1.4) to start CM Authorization process. The Authorization and TEK exchanges between the CM and the CMTS follow the requirements in Section 7.1.1.

- The CM MUST NOT forward traffic from any attached CPE device to the cable network from the time registration completes until after the initialization of Baseline Privacy operations completes for its primary SID/SAID. Registration completion is defined in [DOCSIS MULPIv3.1], and initialization of Baseline Privacy operations completion is defined in Section 5.2.1.
- The CMTS maintains the CM's Authorization state and it MUST verify that the CM completed Authorization exchanges with the CMTS before forwarding user data traffic from the CM. The CMTS MUST drop all user data traffic forwarded by the CM until the CMTS verifies that the CM has completed Authorization.

If EAE is disabled and the CM's configuration file disables BPI+, the CM MUST NOT instantiate an Authorization State Machine or start any TEK state machines.

9 SECURE PROVISIONING

9.1 Introduction

The term "secure provisioning" refers to securing the CM provisioning processes. These processes are defined in [DOCSIS MULPIv3.1] and they are DHCP, ToD, and TFTP at the IP layer; and registration at the MAC layer. Secure provisioning plays a critical role in protecting the CMs and the network from attacks, and in preventing service theft. This section places requirements on the CM and CMTS to support secure provisioning.

9.2 Encryption of Provisioning Messages

When EAE is enabled for a CM, all IP provisioning messages are encrypted by the Primary SAID as the payload of DOCSIS packets. Registration Request MAC management messages are also encrypted.

Of special value is the encryption of TFTP messages. The encryption of TFTP packets protects the confidentiality of the contents of CM configuration files downloaded via TFTP. If a configuration file contains sensitive information, EAE should be enabled for that CM.

9.3 Securing DHCP

9.3.1 Securing DHCP on the Cable Network Link

DHCP is a client-server protocol. When EAE is enabled for a CM, security of unicast DHCP messages between the CMTS and the CM is provided by encrypting DHCP packets as they pass across the cable network link. It is assumed in this specification that the path between the DHCP server and the CMTS is secured through mechanisms outside the scope of this specification (see also Section 5).

9.3.2 DHCPv6

CMs support the lightweight DHCPv6 authentication protocol for IPv6 provisioning (see [DOCSIS MULPIv3.1]). As the lightweight DHCPv6 authentication protocol relies on DHCPv6 messages to distribute Reconfigure keys to the CMs, it is essential that DHCPv6 messages be protected. If a CM is provisioned to accept DHCPv6 Reconfigure messages, then enabling EAE adds additional protection for the value of the Reconfigure key.

9.4 TFTP Configuration File Security

9.4.1 Introduction

This section describes requirements intended to secure the CM configuration file download process, and to ensure that the CM does not receive a different level of service than described by the configuration file.

9.4.2 CMTS Security Features for Configuration File Download

The CMTS supports several features intended to secure the download of CM configuration files:

- A capability to prevent the disclosure of the IP address of the configuration file server (TFTP Proxy, see Section 9.4.2.1);
- A capability to enforce that a CM downloads the correct configuration file according to DHCP configurations offered to the CM (Configuration File Name Authorization, see Section 9.4.2.3);
- A capability to verify that a CM registers with settings that match those in the downloaded configuration file (Configuration File Learning, see Section 9.4.2.4).

9.4.2.1 TFTP Proxy

The CMTS MUST implement a TFTP server and a TFTP client compliant with [RFC 1350]. Both the TFTP server and client in the CMTS MUST support TFTP option extension (see [RFC 2347]), TFTP blocksize option (see

[RFC 2348]) and TFTP timeout interval option (see [RFC 2349]). The CMTS MUST be capable of acting as the TFTP server for CMs to download configuration files. The CMTS MUST be capable of acting as a TFTP client to download configuration files from TFTP servers in the provisioning system. The CMTS MAY support other file transfer protocol clients for CM configuration file download.

When the CMTS acts as the TFTP server for a CM, and at the same time acts as a TFTP client downloading a configuration file from a TFTP server on behalf of the CM, the CMTS is referred to as a TFTP Proxy. The CMTS MUST support the capability to enable or disable TFTP Proxy. By default, the CMTS MUST enable TFTP Proxy.

9.4.2.2 Protecting TFTP Server Addresses

If TFTP Proxy is enabled on a CMTS and a CM is provisioned in IPv4 mode, then the CMTS MUST ensure that the TFTP Server Address Option and/or the `siaddr` field in DHCPACK messages sent to the CM is the CMTS's IP address.

If TFTP Proxy is enabled on a CMTS and a CM is provisioned in IPv6 mode, then the CMTS MUST ensure that the `CL_OPTION_TFTP_SERVERS` suboption of the `OPTION_VENDOR_OPTS` in Reply messages sent to the CM is the CMTS's IP address.

If TFTP Proxy is enabled and a valid configuration download TFTP request has been received from a CM, the CMTS MUST acquire the configuration file from the configuration server identified in the DHCPACK (DHCPv4), or Reply (DHCPv6) messages relayed to the CM, and download it to the CM.

If TFTP Proxy is enabled on a CMTS, and if the provisioning system uses multiple configuration file servers, then the CMTS SHOULD support a mechanism that uses the multiple TFTP servers. The CMTS SHOULD implement a retry mechanism that synchronizes TFTP retries by the CM and by the CMTS. These mechanisms are not defined by this specification.

9.4.2.3 Configuration File Name Authorization

The CMTS MUST support the capability to maintain a list of authorized DHCP servers.

The CMTS MUST support the capability to learn the name of a CM's configuration file from the DHCP configurations offered to the CM from an authorized DHCP server. The learned configuration file name identifies the configuration file that the CM is authorized to download.

The CMTS MUST support the capability to discard CM TFTP Requests if the name of the configuration file requested by a CM is not identical to the learned name of the configuration file. This capability is referred to as Configuration File Name Authorization. The CMTS MUST enable or disable Configuration File Name Authorization when the TFTP Proxy feature is enabled or disabled, respectively.

9.4.2.4 Configuration File Learning

When TFTP Proxy is enabled on a CMTS, the CMTS downloads configuration files on behalf of CMs, and the CMTS can learn about CMs' configuration files. The CMTS MUST support a capability to learn about the CM's configuration file. This capability is referred to as Configuration File Learning. The CMTS MUST be capable of being configured to enable or disable Configuration File Learning. By default, the CMTS MUST enable Configuration File Learning.

The CMTS MUST support the capability to enforce that a CM's Registration is consistent with what the CMTS has learned about the CM's configuration file.

.If TFTP Proxy and Configuration File Learning are both enabled on a CMTS, and the CM's Registration is not consistent with what the CMTS has learned about the CM's configuration file (e.g., based on CMTS MIC calculation, or comparison of parameters used in CMTS MIC calculation), then the CMTS MUST respond with an Authentication Failure in the registration response status field (see [DOCSIS MULPIv3.1]). The CMTS MUST also log an event.

9.4.2.5 TFTP Options for CM's MAC and IP Address

When TFTP Proxy is enabled on a CMTS, the client requesting a file from the backend provisioning system is the CMTS rather than the CM. However, some provisioning systems rely on the availability of the CM MAC and IP address in the request.

In order to allow this information to reach the provisioning system, the CMTS MUST support the MAC Address and IP Address TFTP options (see Annex B). Enabling support for these options MUST be independently configurable on the CMTS with the default being disabled.

When a CM requests a configuration file and the IP Address option is enabled on the CMTS, the CMTS MUST include the CM's IP address in the "netaddr" TFTP option. When a CM requests a configuration file and the MAC address is enabled on the CMTS, the CMTS MUST include the CM's MAC address in the "hwaddr" TFTP option. If a TFTP packet received from a CM already includes these options, the CMTS MUST discard those options and include only the enabled TFTP options with source address values from the received packet. When either the IP address or MAC Address option is enabled, the CMTS MUST NOT cache configuration files locally.

9.5 Securing REG-REQ-MP Messages

Encryption of packet data carried in DOCSIS frames provides confidentiality of CM configuration files. A subset of the parameters contained in configuration files is communicated to the CMTS in REG-REQ-MP messages (see [DOCSIS MULPIv3.1]). To maintain confidentiality of these parameters, when EAE is enabled the CM MUST encrypt the REG-REQ-MP message (see Section 6.5). The key for encrypting the REG-REQ-MP message is the Primary SA TEK. If EAE is enabled and the configuration file disables BPI+, the CM MUST complete registration before terminating the authorization and TEK state machines.

9.6 Source Address Verification

The CMTS is responsible only for forwarding CPE packets that contain legitimate addresses. This section imposes on the CMTS requirements designed to permit an operator to ensure that CPEs located behind CMs cannot successfully spoof addresses in order to obtain unauthorized access to services or to disrupt services to others. These CMTS requirements are referred to as Source Address Verification (SAV).

A design goal of the SAV feature is that it applies in deployment scenarios where CPEs are directly connected to a CM and where CPEs are behind a router that is connected to a CM. The router may be embedded with the CM or standalone.

The CMTS MUST be capable of being configured to enable and disable SAV. By default, the CMTS MUST enable SAV. When the SAV feature is enabled, the CMTS MUST drop any received upstream packets whose IP source address has not been assigned by the operator. This includes packets whose source IP address is an IP address that has been assigned to another device. When multiple devices are assigned the same IP address, it is left to CMTS vendor implementation to determine which packet to drop when upstream packets from different devices with the same assigned source IP address are received. Source IP addresses are considered assigned by the operator when they are provisioned via DHCP messaging or identified by parameters in the configuration file.

The CM configuration file can contain the following TLV encodings (see [DOCSIS MULPIv3.1]) that are used to indicate IP addresses that have been assigned by the operator, but are not issued by a DHCP server:

1. An SAV Prefix Group ID Encoding that identifies a list of prefixes configured at the CMTS; or
2. A Static SAV Prefix Encoding that statically defines an IP prefix authorized for source IP addresses of upstream traffic from the CM.

A valid CM configuration file has a single SAV Group Encoding and may have one or more Static SAV Prefix Encodings.

The CMTS MUST consider all upstream IP packets on all SIDs assigned to a CM as containing a source IP address assigned by the operator when the source IP address:

1. Matches the Subscriber Management CPE IPv4 or IPv6 Encoding (see [DOCSIS MULPIv3.1]) signaled for that CM in a REG-REQ-MP; or

2. Matches a prefix in the CMTS prefix list referenced by the SAV Group ID Encoding (see [DOCSIS MULPIv3.1]) signaled for that CM in a REG-REQ-MP; or
3. Matches a Static SAV Prefix Encoding signaled for that CM in a REG-REQ-MP, or
4. Was learned from an authorized DHCP server. Examples include:
 - a) The CMTS extracts assigned IP address information from DHCPv4 DHCPACK message sent in response to an upstream DHCPv4 DHCPREQUEST, or from a DHCPv6 Reply message sent in response to an upstream DHCPv6 Request received from a CM's SID;
 - b) Use of a CMTS initiated DHCPv4 DHCPLEASEQUERY or DHCPv6 Leasequery response that verifies the assigned IP address for a host source MAC address;
 - c) The CMTS extracts assigned IPv6 prefix from an IPv6 prefix delegation option.

The DHCP Leasequery protocols have been specified to facilitate the exchange of data between a CMTS and DHCP server. The CMTS MAY implement the following standards to support interactions with provider DHCP server(s) related to SAV: the DHCP Leasequery protocol which is specified in [RFC4388]; the DHCPv6 Leasequery protocol and related standards which are specified in [RFC5007] and [RFC4994]. The CMTS MAY implement other mechanisms for determining whether IP addresses have been assigned by the operator, e.g., when the source IP address is within an IP subnet authorized as routed downstream to a next hop router reached through the CM.

The CMTS MUST be capable of being configured to enable and disable the use of the SAV Group ID Encoding and Static SAV Prefix Encoding for identification of operator assigned IP addresses.

When Source Address Verification is enabled, a routing CMTS MUST respond in proxy to an upstream address resolution request (IPv4 ARP Request or IPv6 Neighbor Solicitation) for downstream target IP addresses that it has verified instead of reflecting the request downstream.

Whether or not SAV is enabled, the CMTS MUST discard upstream IP packets received on a SID assigned to an initializing CM and all upstream IP packets on all SIDs of the CM after it has finished the initialization process when the source IP address does not match the IP address assigned to the CM by an authorized DHCP server. An initializing CM is one that has not yet completed registration.

The CMTS provides per-CM statistics of the number of packets discarded due to SAV failure.

9.7 Address Resolution Security Considerations

Address Resolution Protocol (ARP) (see [RFC 826]) is a protocol for dynamically mapping an IP address to the corresponding link layer address (e.g., IEEE Ethernet MAC address) in the local network. Neighbor Discovery (ND) is an IPv6 protocol (see [RFC 4861]) that provides the same function. A routing CMTS uses ARP or ND for IP address resolution of downstream IP host addresses in a directly connected downstream IP subnet. Downstream IP subnets include the IP addresses for CMs, eSAFEs, and CPE hosts directly connected to the network segment to which a CM's external CPE interface attaches.

ARP is a broadcast protocol. ARP requests are broadcast to, and received and processed by, all devices on the network segment. An IPv6 Neighbor Solicitation message for address resolution is a multicast packet. For purposes of this section, an "address resolution request" packet is defined as an IPv4 ARP request or IPv6 Neighbor Solicitation (NS) message. An "address resolution response" packet is an IPv4 ARP reply or an IPv6 Neighbor Advertisement (NA) message. This section describes CMTS requirements concerning the monitoring and limiting of address resolution request messages.

Because the downstream and upstream are physically separate media in DOCSIS, CMs cannot directly perform address resolution with other CMs on the cable plant. As a result, the CMTS is involved in the MAC-to-IP address resolution process, either by echoing resolution request / response packets between downstream and upstream, by acting in proxy for the address resolution target, or by bridging the resolution request / response packets between the cable interfaces and the NSI interfaces.

If the CMTS knows the Ethernet MAC address corresponding to a host IP address, the host IP address is said to be "resolved" at the CMTS; otherwise, the host IP address is said to be "unresolved." When a routing CMTS attempts to forward an IP packet (upstream or downstream) to an unresolved downstream host IP address, the CMTS MAY originate a downstream address resolution request for that host IP address. When a CMTS receives an upstream address resolution request to an unresolved target, it MAY reflect that request downstream. The [DOCSIS MULPIv3.1] specification describes requirements for downstream forwarding of broadcast ARP requests and multicast NS requests.

Because ARP is a broadcast protocol and downstream address resolution (ARP or ND) consumes CMTS resources for pending address resolution requests, a routing CMTS is susceptible to a denial of service attack that attempts to exhaust the CMTS's resources for pending address resolutions. Furthermore, ARP "storms" can occur when large numbers of ARP requests or unresolved IP destination packets are received by the CMTS, impairing the ability of the CMTS to process legitimate traffic. ARP storms may also be caused by ill-configured or malfunctioning customer equipment and computer systems.

A characteristic of a CPE host infected with a virus is that it attempts to discover other potential victims by originating ARP / NS requests to many other hosts in its same IP subnet. During virus attacks, hundreds of packets per second to unresolved host IP addresses can be received by the CMTS. Although the Neighbor Solicitation message is a solicited-node multicast address instead of a broadcast address, the occurrence of a high rate of NS messages upstream from a CM is a likely indicator that a CPE host connected to the CM is infected with a virus that is attempting to discover other hosts on the same IPv6 link layer subnet.

This section defines CMTS requirements for mitigating ARP storms, and to assist with the discovery of which CMs attach to CPE hosts that may be infected by computer viruses.

The Source Address Verification (SAV) feature, when enabled, mitigates address resolution denial of service by requiring a routing CMTS to respond in proxy to upstream address resolution requests instead of reflecting them down stream.

The CMTS MUST support the capability to limit the rate at which it transmits downstream address resolution requests. This requirement applies to downstream address resolution requests generated either when reflecting an upstream request or to resolve the Ethernet MAC address of an IP packet to be forwarded downstream. The configuration of downstream address resolution request limiting is CMTS vendor specific.

The CMTS MUST implement a management object for each CM that accumulates the count of upstream address resolution request packets received on SIDs assigned to the CM. The upstream address resolution request packet count includes the following:

- Upstream IPv4 ARP Requests;
- Upstream IPv6 Neighbor Solicitation Requests;
- (For routing CMTSs) Upstream IPv4 or IPv6 packets to unresolved destinations in locally connected downstream subnets.

The Upstream Address Resolution Requests counter is intended to be analyzed by MSO management processes that obtain the counter via SNMP or IPDR. CMs with high rates of upstream address resolution requests are likely to have CPEs infected with viruses attempting to locate other victims.

10 USING CRYPTOGRAPHIC KEYS

10.1 CMTS

The CMTS's first receipt of an Authorization Request message from an unauthorized CM initiates the activation of a new Authorization Key (AK), which the CMTS returns to the CM in an Authorization Reply message (see Section 7). This AK will remain active until it expires according to its predefined lifetime, Authorization Key Lifetime, which is a CMTS system configuration parameter (see Annex A).

The CMTS uses keying material derived from the CM's Authorization Key for:

- Verifying the HMAC-Digest in Key Requests received from the CM;
- Encrypting (EDE mode two-key 3DES) the TEK in the Key Replies that it sends to the CM;
- Calculating the HMAC-Digests in Key Replies, Key Rejects, and TEK Invalids sent to the CM.

See Section 7 for TEK messaging (Key Requests, Key Replies, Key Rejects, etc.) details.

The CMTS **MUST** be prepared to send an AK upon request. The CMTS **MUST** be able to support two simultaneously-active AKs for each client CM.

If the CMTS holds two active Authorization Keys for a CM, it responds to Authorization Requests with the newer of the two active keys. If the CMTS holds a single active Authorization Key, a received Authorization Request will trigger the activation of a new AK, as described below.

An Authorization Key "transition period" begins when the CMTS receives an Authorization Request from a CM and the CMTS has a single active AK for that CM. In response to this Authorization Request, the CMTS activates a second AK, which it returns to the requesting CM in an Authorization Reply. The CMTS **MUST** set the active lifetime of this second AK to be the remaining lifetime of the first AK plus the predefined Authorization Key Lifetime. The key transition period ends with the expiration of the older key. This is depicted in the top half of Figure 10-1.

The Authorization Key lifetime that the CMTS reports in an Authorization reply **MUST** be set to the remaining lifetimes of the AKs at the time the reply message is sent.

If a CM fails to reauthorize before the expiration of its most recently-acquired AK, the CMTS will hold no active Authorization keys for the CM and will consider the CM unauthorized. A CMTS **MUST** deactivate all TEKS associated with an unauthorized CM.

The CMTS tracks the lifetime of its Authorization Keys; the CMTS **MUST** immediately deactivate a key once it has expired.

A CMTS **MUST** use a CM's active AK(s) to verify the HMAC-Digest in Key Requests received from the CM. If a CMTS receives a Key Request while in an AK transition period, and the AK Key Sequence Number indicates that the Request was authenticated with the newer of the two AKs, the CMTS **MUST** recognize this as an implicit acknowledgment that the CM has obtained the newer of the CM's two active AKs.

The CMTS **MUST** use an active AK when calculating HMAC-Digests in Key Replies, Key Rejects and TEK Invalids, and when encrypting the TEK in Key Replies. When sending Key Replies, Key Rejects or TEK Invalids within a key transition period and the newer key has been implicitly acknowledged, the CMTS **MUST** use the newer of the two active. If the newer key has not been implicitly acknowledged, the CMTS **MUST** use the older of the two active AKs.

Figure 10-1 illustrates the CMTS's use of AKs.

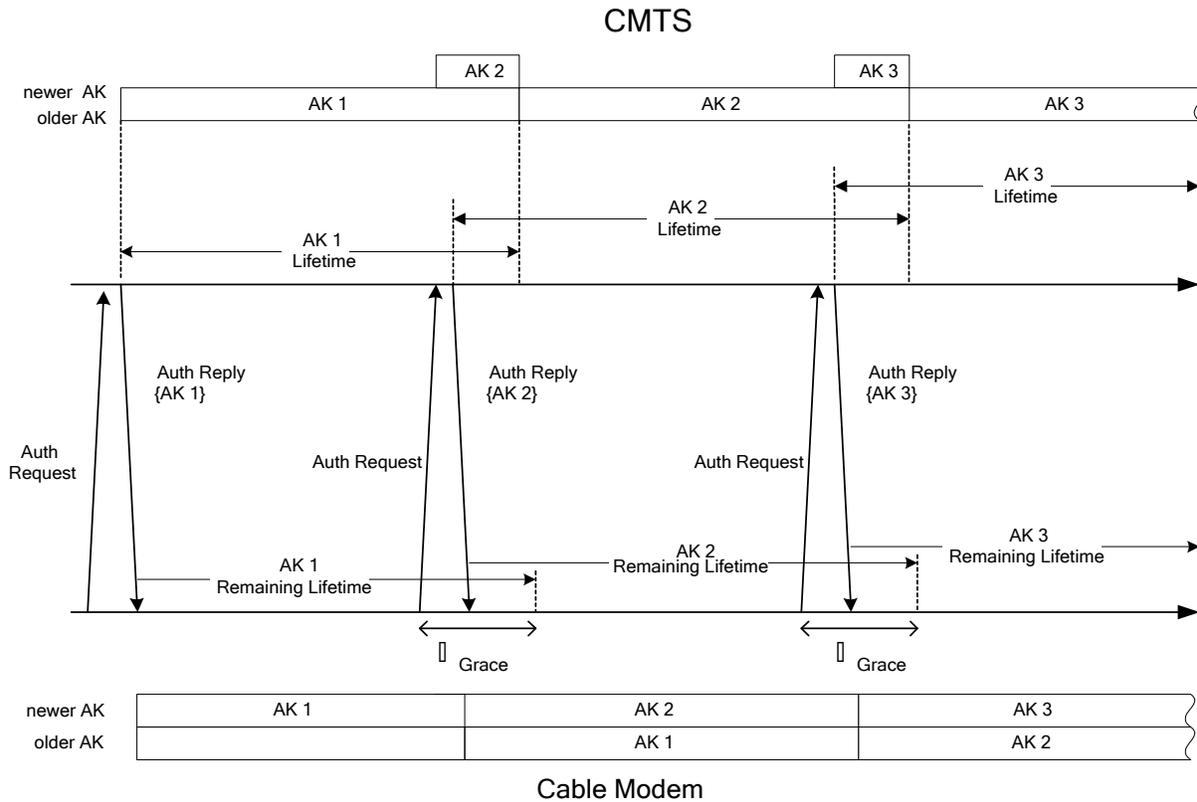

Figure 10-1 - Authorization Key Management in CMTS and CM

The CMTS MUST be capable of maintaining two sets of active traffic encryption keys (and their associated CBC initialization vectors) per SAID. These correspond to two successive generations of keying material, and have overlapping lifetimes. The CMTS MUST make the newer TEK have a key sequence number one greater than that of the older TEK (modulo 16). Each TEK becomes active halfway through the lifetime of its predecessor and expires halfway through the lifetime of its successor. Once a TEK expires, the TEK becomes inactive and the CMTS MUST NOT use that TEK.

For each of its SAIDs, the CMTS transitions between active TEKs according to the following rules:

- For encrypting downstream traffic, the CMTS MUST use the oldest available active TEK;
- For decryption of upstream traffic, a transition period is defined that begins once the CMTS has sent the newer TEK to a CM within a Key Reply Message. The upstream transition period begins from the time the CMTS sends the newer TEK in a Key Reply Message and concludes once the older TEK expires. While in the transition period, the CMTS MUST be able to decrypt upstream traffic with whichever of the two active TEKs was used to encrypt it.

In other words, the CMTS encrypts with a given TEK for only the second half of that TEK's total lifetime; the CMTS is able, however, to decrypt with a given TEK for that TEK's entire lifetime.

The KEY_SEQ field in the Baseline Privacy EH element identifies which of the two active TEKs was used to encrypt the upstream frame's packet data. The TOGGLE bit in the Privacy EH element (which is required to be equal to the least significant bit of the KEY_SEQ field) can be used by the CMTS to identify the encrypting TEK. Figure 10-2 illustrates how a CMTS manages TEKs. The Key Replies sent by a CMTS contain TEK parameters (the TEK itself, a key lifetime, a key sequence number and a CBC IV) for the two active TEKs. The key lifetimes

that a CMTS reports in a Key Reply MUST be set to the remaining lifetimes of these TEKs at the time that the Key Reply message is sent.

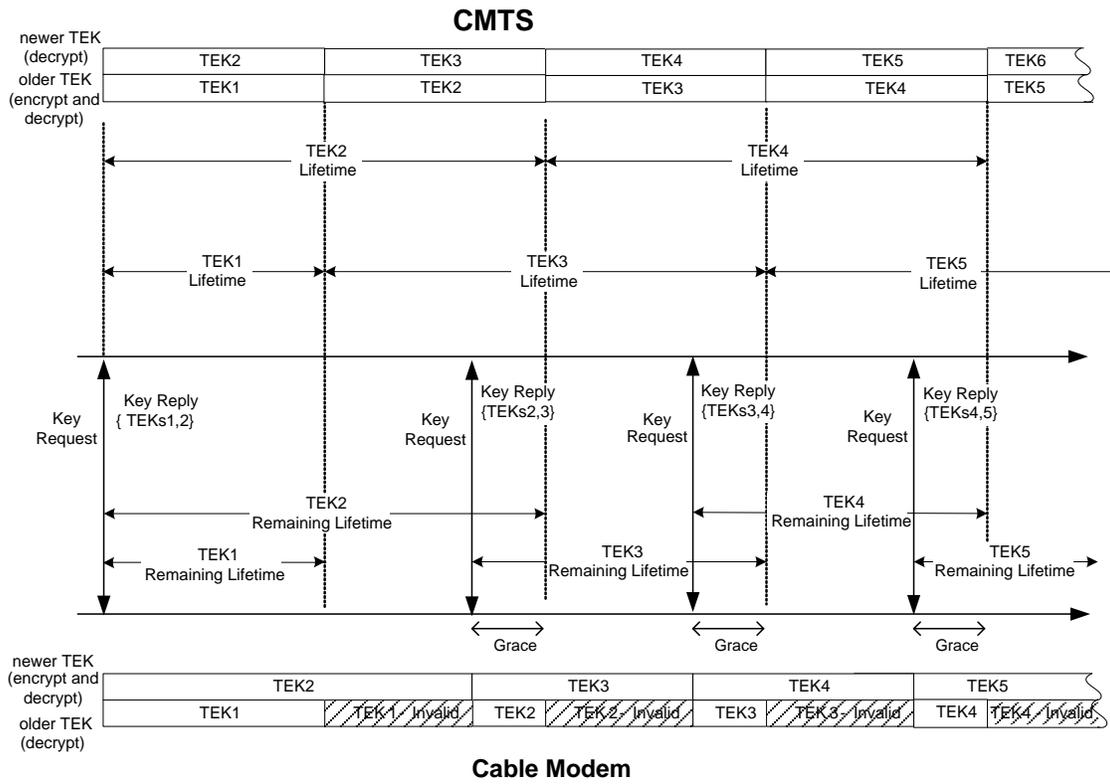

Figure 10-2 - TEK Management in CMTS and CM

10.2 Cable Modem

The CM is responsible for maintaining two active Authorization Keys. A CM MUST be able to use any active AK. AKs have a limited lifetime and are periodically refreshed. A CM refreshes its Authorization Key by sending an Authorization Request to the CMTS. The Authorization state machine (Section 7.1.4) manages the scheduling of Authorization Requests for refreshing AKs.

A CM's Authorization state machine schedules the beginning of reauthorization a configurable length of time (the Authorization Grace Time) before the CM's most-recently-acquired AK is scheduled to expire. The Authorization Grace Time is configured to provide a CM with an authorization retry period that is sufficiently long to allow for system delays and to provide adequate time for the CM to complete an Authorization exchange before the expiration of its most current AK.

The CM MUST use the most recently acquired Authorization Key when calculating the HMAC-Digests attached to Key Requests. The CM MUST be able to use either of its two most recently acquired AKs to authenticate Key Replies, Key Rejects and TEK Invalids, and to decrypt a Key Reply's encrypted TEK. The CM MUST use the AK Key Sequence Number to determine which of the two AKs to use.

The lower half of Figure 10-1 illustrates a CM's maintenance and use of its Authorization Keys.

A CM MUST be capable of maintaining two sets of traffic keying material per authorized SAID. Through operation of its TEK state machines, a CM attempts to maintain a SAID's two most recent sets of traffic keying material.

For each of its authorized SAIDs, the CM:

- MUST use the newer of its two TEKs to encrypt newly received upstream traffic.
- MUST use an unexpired TEK for traffic already queued for transmission.
- MUST be able to decrypt downstream traffic encrypted with either active TEK.

10.3 Authentication of Dynamic Service Requests

10.3.1 CM

If BPI+ is enabled, the CM MUST include HMAC-Digests in the following MAC management messages:

- DSA-REQ, DSA-RSP, DSA-ACK;
- DSC-REQ, DSC-RSP, DSC-ACK;
- DSD-REQ;
- DCC-RSP;
- DBC-RSP.

These HMAC-Digests are keyed with the message authentication keys derived from the Authorization Key. The CM MUST use the current message authentication keys when generating and validating the HMAC-Digests contained in the above messages.

10.3.2 CMTS

If BPI+ is enabled for a CM, the CMTS MUST include HMAC-Digests in the following MAC management messages sent to that CM:

- DSA-REQ, DSA-RSP, DSA-ACK;
- DSC-REQ, DSC-RSP, DSC-ACK;
- DSD-REQ;
- DCC-REQ, DCC-ACK;
- DBC-REQ, DBC-ACK.

These HMAC-Digests are keyed with the message authentication keys derived from the Authorization Key. The CMTS MUST use the current message authentication keys when generating and validating the HMAC-Digests contained in the above messages.

11 CRYPTOGRAPHIC METHODS

This section specifies cryptographic algorithms and key sizes.

11.1 Packet Data Encryption

The CMTS MUST use the CBC mode (see [NIST-800-38A]) of either the Data Encryption Standard (DES) algorithm (see [FIPS 46-3]) or the Advanced Encryption Standard (AES) algorithm (see [FIPS 197]) to encrypt the Packet Data field, RF MAC PDU Frames. The CM MUST use the CBC mode (see [NIST-800-38A]) of either the Data Encryption Standard (DES) algorithm (see [FIPS 46-3]), or the Advanced Encryption Standard (AES) algorithm (see [FIPS 197]) to encrypt the Packet Data field, RF MAC PDU Frames, and the Fragmentation Payload and Fragmentation CRC Fields in MAC Fragmentation Frames.

The CM MUST support one-hundred twenty-eight (128)-bit AES (i.e., a 128 bit key) with a one-hundred twenty-eight (128)-bit block. The CM MUST support fifty-six (56)-bit DES. The CM MAY support forty (40)-bit DES.

The CMTS MUST support one-hundred twenty-eight (128)-bit AES (i.e., 128 bit key) with a one-hundred twenty-eight (128)-bit block. The CMTS MUST support fifty-six (56)-bit DES. The CMTS MAY support forty (40)-bit DES.

BPI+ supports forty (40)-bit DES principally to permit interoperability with forty (40)-bit DOCSIS 1.0 hardware upgraded to run BPI+. Forty (40)-bit DES is identical to fifty-six (56)-bit DES, with the exception that sixteen (16) bits of the fifty-six (56)-bit DES key are set to known, fixed values. If a CM is running the optional forty (40)-bit DES, it MUST mask off (to zero) the sixteen (16) left-most bits of any fifty-six (56)-bit DES key prior to running encryption/decryption operations. If a CMTS is running the optional forty (40)-bit DES, it MUST mask off (to zero) the sixteen (16) left-most bits of any fifty-six (56)-bit DES key prior to running encryption/decryption operations.

NOTE: The masked bits are the sixteen (16) left-most bits that would be present after the removal of every eighth bit from the sixty-four (64)-bit TEK (i.e., the so-called parity bits). DOCSIS 1.1 or 2.0 and fifty-six (56)-bit DOCSIS 1.0 or 2.0 hardware running BPI+ may implement forty (40)-bit DES key masking in software.

The CMTS MUST initialize CBC mode with the initialization vector that is provided in the CMTS's Key Reply. The CMTS MUST perform chaining block-to-block within a frame. The CMTS MUST reinitialize chaining with each frame.

The CM MUST initialize CBC mode with the initialization vector that is provided in the CMTS's Key Reply. The CM MUST perform chaining block-to-block within a frame. The CM MUST reinitialize chaining with each frame.

The CMTS MUST use residual termination block processing, as defined below, to encrypt the final block of plain text when the final block is less than the block length defined for the encryption algorithm. The CM MUST use residual termination block processing, as defined below, to encrypt the final block of plain text when the final block is less than the block length defined for the encryption algorithm.

Given a final block having n bits, where n is less than the defined block length for the encryption algorithm:

- The next-to-last ciphertext block is encrypted a second time, using the ECB mode of the encryption algorithm, and the left most n bits of the result are XOR'd with the final n bits of the payload to generate the short final cipher block. In order for the receiver to decrypt the short final cipher block, the receiver encrypts the next-to-last ciphertext block using the ECB mode of the encryption algorithm, and XORs the left-most n bits with the short final cipher block in order to recover the short final cleartext block (see [SCTE 52] for more details).
- In the special case when the frame's to-be-encrypted plaintext is less than the length of the block, the initialization vector is encrypted, and the left-most n bits of the resulting ciphertext corresponding to the number of bits of the payload are XORed with the n bits of the payload to generate the short cipher block.

NOTE: This method of encrypting short payloads is vulnerable to attack: XORing two sets of ciphertext encrypted in the above manner under the same set of keying material will yield the XOR of the corresponding sets of plaintext. In the case of PDU frames, however, this is not an issue since all frames carrying protected user

data will contain at least 20 bytes of IP header. In the case of Fragmentation Frames, short frames are possible and a few octets may be exposed by this XOR attack.

11.2 Encryption of the TEK

The CMTS encrypts the value fields of the TEK in Key Reply messages. This field is encrypted using two-key 3DES in the encrypt-decrypt-encrypt (EDE) mode.

Encryption: $C = E_{k1}[Dk2[E_{k1}[P]]]$

Decryption: $P = D_{k1}[E_{k2}[D_{k1}[C]]]$

P = Plaintext TEK

C = Ciphertext TEK

k1 = left-most 64 bits of the 128-bit KEK

k2 = right-most 64 bits of the 128-bit KEK

E[] = 56-bit DES ECB mode encryption

D[] = 56-bit DES ECB decryption

Section 11.4 describes how the KEK is derived from the Authorization key.

11.3 HMAC-Digest Algorithm

When creating or verifying the `HMAC-Digest` attribute, the CMTS MUST use the HMAC message authentication method (see [RFC 2104]) with the SHA-1 hash algorithm (see [FIPS 180-4]). When creating or verifying the `HMAC-Digest` attribute, the CM MUST use the HMAC message authentication method (see [RFC 2104]) with the SHA-1 hash algorithm (see [FIPS 180-4]).

Upstream and downstream message authentication keys are derived from the Authorization Key (see Section 11.4 for details).

11.4 TEKs, KEKs, and Message Authentication Keys

The CMTS generates Authorization Keys, TEKs and IVs. The CMTS MUST use a random or pseudo-random number generator to generate Authorization Keys, TEKs and IVs. The CMTS should follow practices recommended in [RFC 4086] for generating random numbers for use within cryptographic systems.¹¹ [FIPS 46-3] defines DES keys as 8-octet (64-bit) quantities in which the seven most significant bits (i.e., seven left-most bits) of each octet are the independent bits of a DES key, and the least significant bit (i.e., right-most bit) of each octet is a parity bit computed on the preceding seven independent bits and adjusted so that the octet has odd parity. The CM MUST ignore the value of the least significant bit of each octet in DES keys. It is not necessary for the CMTS to calculate parity bits in generated DES keys.

The keying material for two-key 3DES consists of two distinct DES keys.

A key encryption key (KEK) and two message authentication keys (HMAC_KEY_U for authenticating upstream Key Request messages, HMAC_KEY_D for authenticating downstream Key Reply, Key Reject and TEK Invalid messages) are derived from a common Authorization Key. The CMTS MUST derive these keys, as shown below. The CM MUST derive these keys as shown below:

KEK = Truncate (SHA-1(K_PAD | AUTH_KEY), 128)

HMAC_KEY_U = SHA-1(H_PAD_U | AUTH_KEY)

HMAC_KEY_D = SHA-1(H_PAD_D | AUTH_KEY)

Where:

¹¹ Modified per SECv3.1-N-15.1342-1 on 8/25.15 by KB.

SHA-1($x \parallel y$) denotes the result of applying the SHA-1 function to the concatenated bit strings x and y ;

Truncate(x, n) denotes the result of truncating x to its left-most n bits;

and K_PAD , H_PAD_U and H_PAD_D are 512-bit strings:

$K_PAD = 0x53$ repeated 63 times;

$H_PAD_U = 0x5C$ repeated 63 times;

$H_PAD_D = 0x3A$ repeated 63 times; and

$AUTH_KEY$ is the Authorization Key.

11.5 Public-Key Encryption of Authorization Key

The CMTS MUST encrypt authorization keys in Authorization Reply messages with the CM's public key. The CM public key MUST be suitable for use with the RSA algorithm (see [RSA3]).

The CM's RSA key MUST have a public exponent of F_4 (65537 decimal, 0x010001). The CM's RSA key MUST have a modulus length of 1024 bits for the legacy PKI certificate and 2048 bits for the new PKI certificate. The CMTS MUST use the RSAES-OAEP encryption scheme defined in [RSA3]. When performing this encryption, the CMTS MUST use:

1. SHA-1 for the hash function;
2. MGF1 with SHA-1 for the mask-generation function; and
3. The empty string for the encoding parameter string.

NOTE: Baseline Privacy (see [SCTE 22-2]) employed the encryption scheme described in version 1.5 of the PKCS #1 standard (see [RSA1]). This is the same scheme as RSAES-PKCS1-v1_5 in [RSA3].

In order to maintain backwards compatibility, CMTSs MUST revert to RSAES-PKCS1-v1_5 for encrypting the authorization key when falling back to BPI.

In order to interoperate with earlier versions of this specification, the CMTS MUST support 768-bit and 1024-bit key moduli.

11.6 Digital Signatures

All DOCSIS certificates use the RSA signature algorithm (see [RSA3]) with the SHA-256 hash (see [FIPS 180-4]).

Device CAs use signature keys with a modulus 3072 bits.

11.7 The MMH-MIC

In this section the MMH Function and the MMH MIC are described. The MMH MIC is included in the CM configuration file to verify the integrity of various encodings (see [DOCSIS MULPIv3.1]).

11.7.1 The MMH Function

The Multilinear Modular Hash (MMH) function described below is a variant of the MMH function described in [MMH]. Some of the computations described below use signed arithmetic whereas the computations in [MMH] use unsigned arithmetic. The signed arithmetic variant described here was selected for its computational efficiency. All of the properties shown for the MMH function in [MMH] continue to hold for the signed variant.

The MMH function has three parameters: the word size, the number of words of input, and the number of words of output. $MMH[\omega, \sigma, t]$ specifies the hash function with word size ω , σ input words and t output words. For DOCSIS, the word size is fixed to 16 bits: $\omega = 16$. The number of output words is fixed at 4 (i.e., 8 octets): $t = 4$. Thus, DOCSIS uses $MMH[16, \sigma, 4]$. The following sections first describe the calculation $MMH[16, \sigma, 1]$, followed by the method to extend this to $MMH[16, \sigma, 4]$.

11.7.1.1 MMH[16, σ , 1]

For the remainder of this section, MMH[16, σ , 1] is denoted by the symbol \mathcal{H}^1 . In addition to σ words of input, \mathcal{H}^1 also takes as input a key of σ words. When \mathcal{H}^1 is used in computing the MMH-MAC, the key is denoted by κ and the i th word of the key by κ_i :

$$\kappa = \kappa_1, \kappa_2, \dots, \kappa_\sigma$$

Likewise, the input message is denoted by M and the i th word of the input message by M_i :

$$M = M_1, M_2, \dots, M_\sigma$$

To describe \mathcal{H}^1 , the following definitions are needed:

For any even positive integer n , S_n is the set of n integers:

$$S_n = \{-n/2, \dots, 0, \dots, (n/2) - 1\}$$

For example,

$$S_{2^{16}} = \{-2^{15}, \dots, 0, \dots, 2^{15} - 1\}$$

is the set of signed 16 bit integers.

For any integer z , $z \sigma \bmod n$ is the unique element ω of S_n such that $z \equiv \omega$, modulo n .

For example, if z is a 32-bit signed integer in 32-bit twos-complement representation, then $z \sigma \bmod 2^{16}$ can be computed by taking the 16 least-significant bits of z and interpreting those bits in 16-bit twos-complement representation.

For any positive integer q , the set of q integers $\{0, 1, \dots, q-1\}$ is denoted Z_q .

As described above, \mathcal{H}^1 takes as input a key of σ words (each of length 16 bits). Each of the σ words of the key is interpreted as a 16-bit signed integer, i.e., an element of $S_{2^{16}}$.

\mathcal{H}^1 also takes an input message of σ words. Like the key, each of the σ words is interpreted as a 16-bit signed integer, i.e., an element of $S_{2^{16}}$.

The output of \mathcal{H}^1 is a single unsigned 16-bit integer, i.e., an element of $Z_{2^{16}}$. In other words, the range of \mathcal{H}^1 is $S_{2^{16}}^\sigma \times S_{2^{16}}^\sigma$ and the domain is $Z_{2^{16}}$.

\mathcal{H}^1 is defined by the following series of steps. Each step is discussed in further detail below:

For $\kappa, M \in S_{2^{16}}^\sigma$,

Define \mathcal{H}_1 as $\mathcal{H}_1(\kappa, M) = \sum_{i=1}^{\sigma} \kappa_i \cdot M_i \sigma \bmod 2^{32}$.

Define \mathcal{H}_2 as $\mathcal{H}_2(\kappa, M) = \mathcal{H}_1(\kappa, M) \bmod p$, where p is the prime number $p = 2^{16} + 1$.

Define \mathcal{H}^1 as $\mathcal{H}^1(\kappa, M) = \mathcal{H}_2(\kappa, M) \bmod 2^{16}$.

Equivalently,

$$\mathcal{H}^1(\kappa, M) = \left(\left(\left(\sum_{i=1}^{\sigma} \kappa_i, M_i \right) \sigma \bmod 2^{32} \right) \bmod p \right) \bmod 2^{16}$$

Step 1. $\mathcal{H}_1(\kappa, M)$ is the inner product of two vectors each of σ 16-bit signed integers. The result of the inner product is taken $\sigma \bmod 2^{32}$ to yield an element of $S_{2^{32}}$. That is, if the inner product is in twos-complement representation of 32 or more bits, the 32 least significant bits are retained and the resulting integer is interpreted in 32-bit twos-complement representation.

Step 2. This step consists of taking an element x of $S_{2^{32}}$ and reducing it $\bmod p$ to yield an element of Z_p . If x is represented in 32-bit twos-complement notation then this reduction can be accomplished as follows. Let a be the unsigned integer given by the 16 most significant bits of x . Let b be the unsigned integer given by the 16 least significant bits of x . There are two cases depending upon whether x is negative.

Case 1: If $x \geq 0$, then $x = 2^{16}a + b$, where $a \in \{0, \dots, 2^{15} - 1\}$ and $b \in \{0, \dots, 2^{16} - 1\}$.

From the modular equation:

$$2^{16}a + b \equiv \left(2^{16}a + b - a(2^{16} + 1) \right) \bmod (2^{16} + 1)$$

it follows that $x \equiv b - a, \bmod p$. The quantity $b - a$ is in the range $\{-2^{15} + 1, \dots, 2^{16} - 1\}$. Therefore, if $(b - a) > 0$, then $x \bmod p = b - a$. If $b - a < 0$, then $x \bmod p = b - a + p$.

Case 2: If $x < 0$, then $x = 2^{16}a + b - 2^{32}$, where $a \in \{2^{15}, \dots, 2^{16} - 1\}$ and $b \in \{0, \dots, 2^{16} - 1\}$.

From the modular equation:

$$2^{16}a + b - 2^{32} \equiv \left(b + 2^{16}a - a(2^{16} + 1) - 2^{32} + 2^{16}(2^{16} + 1) \right) \bmod (2^{16} + 1),$$

it follows that $x \equiv (b - a + 2^{16}) \bmod p$. The range of the quantity $b - a + 2^{16}$ is given by:

$$1 \leq b - a + 2^{16} \leq 2^{17} - 2^{15} - 1 \leq 2p - 1.$$

Therefore, if $b - a + 2^{16} < p$, then $x \bmod p = b - a + 2^{16}$. If $b - a + 2^{16} \geq p$, then $x \bmod p = b - a + 2^{16} - p$.

Step 3. This step takes an element of Z_p and reduces it modulo 2^{16} . This is equivalent to taking the 16 least significant bits.

11.7.1.2 MMH[16, σ , n]

This section describes the MMH function with an output length of n words.

For convenience, let $\mathcal{H}^n = \text{MMH}[16, \sigma, n]$. \mathcal{H}^n takes a key of $\sigma + n - 1$ words. Let $\kappa = \kappa_1, \dots, \kappa_{\sigma+1}$. Furthermore, define $\kappa^{(q)}$ to be the σ words of κ , starting with κ_q , i.e., $\kappa^{(q)} = \kappa_q, \dots, \kappa_{\sigma+q-1}$. For any $\kappa \in S_{2^{16}}^{\sigma+1}$ and $M \in S_{2^{16}}^{\sigma}$, $\mathcal{H}^n(\kappa, M)$ is computed by computing $\mathcal{H}^1(\kappa^{(1)}, M), \dots, \mathcal{H}^1(\kappa^{(n)}, M)$ and concatenating the results. That is:

$$\mathcal{H}^n(\kappa, M) = \mathcal{H}^1(\kappa^{(1)}, M) \circ \mathcal{H}^1(\kappa^{(2)}, M) \circ \dots \circ \mathcal{H}^1(\kappa^{(n)}, M).$$

11.7.1.3 MMH[16, σ , 4]

It follows directly from Section 11.7.1.2 that:

$$\begin{aligned} \mathcal{H}^4(\kappa, M) &\equiv \text{MMH}[16, \sigma, 4](\kappa, M) \\ &\equiv \mathcal{H}^1(\kappa^{(1)}, M) \circ \mathcal{H}^1(\kappa^{(2)}, M) \circ \mathcal{H}^1(\kappa^{(3)}, M) \circ \mathcal{H}^1(\kappa^{(4)}, M) \end{aligned}$$

11.7.1.4 Handling Variable-Size Data

In order to handle data of all possible sizes up to a maximum value, the following rules MUST be followed for computing an MMH function:

- If the data is not a multiple of the word size, pad the data up to a multiple of the word size with octets with the value zero.
- If a key is calculated that is larger than needed for a particular message, truncate the key until it is the correct length.

11.7.2 Definition of MMH-MAC

The MMH-MAC is defined in a manner similar to PacketCable [PKT-SEC]; for a message M , keystream κ , and a one-time pad Π in Z_{2^n} , where the number of bits of output is n :¹²

$$\text{MMH-MAC}(\kappa, M, \Pi) = \mathcal{H}(\kappa, M) + \Pi$$

where the addition is $\text{mod } 2^n$. For DOCSIS, n is 64, and $\mathcal{H}(\kappa, M)$ is $\text{MMH}[16, \sigma, 4](\kappa, M)$.

11.7.3 Calculating the DOCSIS MMH-MAC

The following is the algorithm used for creating a DOCSIS MMH-MAC. This algorithm shares the same cryptographic properties as the algorithm used by PacketCable to protect RTP streams [PKT-SEC].

Initial conditions:

1. The Sender and the Receiver share a secret, S , that is partitioned into two secrets, S_1 and S_2 .
2. The Sender and Receiver share two seeds, Δ_1 and Δ_2 , which are defined in Section 11.7.5.
3. The message to be protected is M .
4. $F(\langle \text{secret} \rangle, \langle \text{seed} \rangle)$ is a pseudo-random generator whose output depends on a shared secret ($\langle \text{secret} \rangle$) and a seed ($\langle \text{seed} \rangle$).
5. The length of the MMH MAC output is 4 words or 8 octets.

Steps to create the DOCSIS MMH-MAC:

1. If M is not a multiple of the word size (2 octets), pad the data up to the next multiple of the word size with octets with the value zero.
2. Calculate a keystream, $\kappa = F(S_1, \Delta_1)$, of sufficient length to generate the MMH function H over (κ, M) . That is, the length of κ is the length of M plus 3 words or 6 octets (the output length of the MMH function, less one word).
3. Calculate the value A , which is the output of the MMH function $H = \text{MMH}(\kappa, M)$.
4. Concatenate $A \circ S_2$.
5. Calculate the first 8 octets of $F(A \circ S_2, \Delta_2)$.

¹² Note, however, that the definition is only similar to the PacketCable definition in the case that the output is one 16-bit word.

6. Use the output of step 5 as the one time pad Π in the calculation of the MMH-MAC as defined in Section 11.7.2.

7. The DOCSIS MMH-MAC = $A + \Pi$ where the addition is mod 2^{64} .

The following test vectors were created using the initial conditions and steps described above:

[Test Vector #1]

Shared Secret in ASCII = Shared secret #1 94476839

Shared Secret in Hex

53 68 61 72 65 64 20 73 65 63 72 65 74 20 23 31
20 39 34 34 37 36 38 33 39

S1 in Hex

53 61 65 20 65 72 74 23 20 34 37 38 39

S2 in Hex

68 72 64 73 63 65 20 31 39 34 36 33

Message in ASCII = DOCSIS 3.0, fulfilling the need for speed

Message in Hex (padded) =

44 4f 43 53 49 53 20 33 2e 30 2c 20 66 75 6c 66
69 6c 6c 69 6e 67 20 74 68 65 20 6e 65 65 64 20
66 6f 72 20 73 70 65 65 64 00

Key in Hex

8f ea 9f 89 3e d7 f4 4d 9c 45 60 2d a9 7d be 3a
99 10 16 6c bc 1b f6 95 26 ca 04 d1 01 94 7f e1
d9 ca 65 99 fa b5 5a f4 40 6f 81 b4 0d c5 ba 7b

MMH64 function output in Hex

62 37 68 38 ee 5d d0 7c

Pad in Hex

c7 39 8f d3 79 47 0d 04

DOCSIS MMH MAC64 output in Hex

29 70 f8 0c 67 a4 dd 80

[Test Vector #2]

Shared Secret in ASCII = Shared secret #2 07782313

Shared Secret in Hex

53 68 61 72 65 64 20 73 65 63 72 65 74 20 23 32
20 30 37 37 38 32 33 31 33

S1 in Hex

53 61 65 20 65 72 74 23 20 37 38 33 33

S2 in Hex

68 72 64 73 63 65 20 32 30 37 32 31

Message in ASCII = The Magic Words are Squeamish Ossifrages

Message in Hex

54 68 65 20 4d 61 67 69 63 20 57 6f 72 64 73 20
61 72 65 20 53 71 75 65 61 6d 69 73 68 20 4f 73
73 69 66 72 61 67 65 73

Key in Hex

e0 9d 69 6b ec 91 d0 09 3c a7 ed 10 e2 e9 cd f2
6c 23 b8 79 d8 d7 28 b0 b9 8d 3f 6a 18 9d a7 56
b3 55 5a 1a b2 22 68 ff 21 54 fa 99 7b cd

MMH64 function output in Hex
37 de 69 df da db 43 54

Pad in Hex
4b eb 8e a8 f4 71 4c 32

DOCSIS MMH MAC64 output in Hex
83 c9 f8 88 cf 4c 8f 86

11.7.4 MMH Key Derivation for CMTS Extended MIC

The CMTS MUST derive the MMH key for the CMTS Extended MIC as defined in this section. The CMTS and the backend provisioning system share a secret key, $\kappa_{CMTS-EMIC}$. This is equivalent to the shared secret S in Section 11.7.3.

From $\kappa_{CMTS-EMIC}$, the CMTS derives two shared secrets, equivalent to S_1 and S_2 in Section 11.7.3:

$$S_1 = S[0] \circ S[2] \circ S[4] \circ \dots \circ S[n-2]$$

$$S_2 = S[1] \circ S[3] \circ S[5] \circ \dots \circ S[n-1]$$

where $S[i]$ is the i th octet of S (with respect to 0) and S contains n octets.

The CMTS uses the ASCII-encoded string "CMTS-EMIC" as the value of Δ_1 in the calculation of the MMH-MAC.

The CMTS uses the ASCII-encoded string "CMTS-EMIC-PAD" as the value of Δ_2 in the calculation of the MMH-MAC.

The CMTS uses the function F as defined in Section 11.7.6 as the pseudo-random number generator when calculating the MMH-MAC.

11.7.5 Shared Secret Recommendations

Although this specification enforces no limitations or requirements on the length or contents of the secret that is shared between the backend provisioning system and the CMTS, it assumes that the secret contains sufficient entropy to ensure adequate cryptographic security when the secret is used in the cryptographic calculations contained in this document. In order to meet this assumption, it is recommended that the shared secret:

1. Be a pseudo-random binary value (as opposed to ASCII or some other simple encoding system that encodes certain bit positions to predictable values); and
2. Have a length of at least 16 octets.

In the event that the output of a hash function over some simple ASCII-encoded message is used as the shared secret (which is *not* recommended), the input message should contain at least 160 characters.

11.7.6 Key Generation Function

Key derivation sections in this document refer to a function $F(S, seed)$ where S is a shared secret from which keying material is derived, and $seed$ is a constant string. The output of $F()$ is a pseudo-random sequence suitable for use as a key. The output of $F(S, seed)$ is generated as follows:

1. From S , generate a derived shared secret, S' , by accumulation as follows: the value S' is obtained by XORing every 16 octets of S , padding with zeroes as necessary (i.e., add zeroes to the end of S to pad it out to a length that is an integral multiple of 16 octets).
2. Use S' as the initial key to the AES-128 (i.e., 128-bit key, 128-bit block) algorithm operating in counter (CTR) mode.

3. For each block of output needed, set the IV equal to the value of the seed, truncated to 128 bits or zero-extended to 128 bits as necessary, and XORed with the number of the block, starting with 1 (one) and incrementing by 1 (one) for each block processed.

The output of $F(S, seed)$ is the concatenation of the blocks of output obtained in step 3. Any unused octets at the end of the last repetition of step 3 are discarded.

12 PHYSICAL PROTECTION OF KEYS IN THE CM

CMs MUST store and maintain the CM Device Certificate RSA private/public key pairs. The CM MUST store the CM Device Certificate private keys in a manner that deters unauthorized disclosure and modification. Also, CMs SHOULD prevent debugger tools from reading the CM Device Certificate private key in production devices by restricting or blocking physical access to memory containing this key.

The CM MUST meet [FIPS 140-2] security requirements for all instances of private and public permanent key storage.

The CM MUST meet [FIPS 140-2] Security Level 1. [FIPS 140-2] Security Level 1 requires minimal physical protection through the use of production-grade enclosures. The reader should refer to the cited document for the formal requirements; however, below is a summary of those requirements.

Under the [FIPS 140-2] classification of "physical embodiments" of cryptographic modules, external CMs are "multiple-chip stand-alone cryptographic modules." [FIPS 140-2] specifies the following Security level 1 requirements for multiple-chip stand-alone modules:

- The chips are to be of production-grade quality, which shall include standard passivation techniques (i.e., a sealing coat over the chip circuitry to protect it against environmental or other physical damage);
- The circuitry within the module is to be implemented as a production grade multiple-chip embodiment (i.e., an IC printed circuit board, a ceramic substrate, etc.);
- The module is to be entirely contained within a metal or hard plastic production-grade enclosure, which may include doors or removable covers.

An internal CM (defined in [DOCSIS CMCIv3.0]) would be classified as a [FIPS 140-2] "multiple-chip embedded cryptographic module." The Security Level 1 requirements for these devices are contained in the first two bullets above.

13 BPI+ X.509 CERTIFICATE PROFILE AND MANAGEMENT

DOCSIS employs [X.509] version 3 digital certificates for authenticating key exchanges between CM and CMTS (see [X.509]). [X.509] is a general-purpose standard; the DOCSIS certificate profile, described here, further specifies the contents of the certificate's defined fields. This certificate profile also defines the hierarchy of trust for the management and validation of DOCSIS certificates.

Except where otherwise noted in Appendix III, DOCSIS certificates comply with [RFC 5280].

The DOCSIS certificate profile draws extensively from the Secure Electronic Transaction (SET) system (see [SET Book 2]). The overall organization of this section, as well as some of the section's contents, reflect that system.

13.1 BPI+ Certificate Management Architecture Overview

The DOCSIS certificate management architecture for BPI+ CM authentication consists of two public key infrastructures (PKIs): a legacy PKI to support backward compatibility with devices implementing older versions of DOCSIS and a new PKI that provides stronger cryptography algorithms and key sizes. The legacy PKI is defined by the DOCSIS 3.0 Security specification [DOCSIS SECv3.0]. The new PKI is defined by this specification. The new PKI consists of a three level hierarchy of trust supporting three types of certificates:

- Root CA Certificate
- Device CA Certificate
- CM Device Certificates

The Root CA Certificate is used as a trust anchor for the PKI and issues the Device CA Certificate which issues the CM Device Certificates. The new PKI uses a "centralized" model where the Device CA is hosted by CableLabs or an approved 3rd party which issues CM Device Certificates to approved manufacturers. CableLabs manages the new PKI and the certificates issued from its CAs (CableLabs Root CA and CableLabs Device CA, see Appendix III). The legacy PKI is also managed by CableLabs.

The Root CA will also be used as a trust anchor for issuing and validating CA and Code Verification Certificates (CVCs) for the Secure Software Download (SSD) process specified in Section 14.

The Root CA generates and distributes to operators a Certificate Revocation List (CRL), identifying revoked manufacturer certificates. The manner in which CRLs are distributed is outside the scope of this specification. In order to reduce the burden on CM devices that are designed to work in multiple geographic regions, an effort will be made to consolidate DOCSIS 3.1 the PKI hierarchy such that the same BPI+ device certificate for DOCSIS 3.1 will also be valid for EuroDOCSIS 3.1 and other international versions of DOCSIS 3.1 and above.

13.2 Cable Modem Certificate Storage and Management in the CM

The CM MUST have two factory installed CM Device Certificates (and their associated private keys). The CM MUST have a CM Device Certificate installed that is issued from the new PKI. The CM MUST have a CM Device Certificate installed that is issued from the legacy PKI. The CM MUST have the same RSA public key in the CM Device Certificate as the RSA public key in the BPKM Attributes depending upon which CM Device Certificate is used for authentication. The CM MUST use the CM Device Certificate issued from the new PKI when authenticating with a DOCSIS 3.1 or higher CMTS. The CM is to use the CM Device Certificate issued from the legacy PKI when authenticating with a DOCSIS 3.0 or older version of DOCSIS CMTS.

The CM's non-volatile memory MUST contain a Root CA certificate for SSD image verification.

The CM's non-volatile memory MUST have two CA certificates (the Device CA Certificate from the new PKI and the Manufacturer CA Certificate from the legacy PKI) that signed the CM Device Certificates. The CM MUST use the Device CA Certificate issued from the new PKI when authenticating with a DOCSIS 3.1 or higher CMTS and use the Manufacture CA Certificate issued from the legacy PKI otherwise. The CM MAY be capable of updating

or replacing the Device CA Certificate or the legacy Manufacturer CA Certificate via the DOCSIS code download file (see Section 14). The CM may embed Device CA or legacy Manufacturer CA certificates.

The CM MUST be able to process certificate serial number values containing 20 octets or fewer. The CM MUST accept certificates that have serial numbers that are negative or zero.

13.3 Certificate Processing and Management in the CMTS

BPKM employs digital certificates to allow CMTSs to verify the binding between a CM's identity (encoded in a digital certificate's subject name) and its public key. The CMTS does this by validating the CM Device Certificate's certification path. This path will typically consist of three chained certificates: the CM Device Certificate, the Device CA certificate (Mfg CA certificate for legacy PKI), and the Root CA certificate (see Section 13.1). Validating the chain follows the "Basic Path Validation" rules defined in [RFC 5280]. The CMTS MUST support validating certificate chains from the legacy PKI defined in DOCSIS 3.0 and the new PKI defined in this specification.

[RFC 4131] requires that CMTSs support administrative controls that allow the operator to override certification chain validation by identifying a particular CA or CM Device Certificate as trusted or untrusted. This section specifies the management model for the exercise of these controls, as well as the processing a CMTS undertakes to assess a CM Device Certificate's validity, and thus verify the binding between the CM's identity and its public key.

The CMTS MUST be able to process certificate `serialNumber` values containing 20 octets or fewer. The CMTS MUST accept certificates that have serial numbers that are negative or zero.

Appendix III describes the format of the subject name field for each type of DOCSIS certificate. The issuer field of a certificate matches exactly the subject field of the issuing certificate. New PKI certificates transmitted by a CM in an Auth Info or Auth Request message have name fields that conform to the format described in Appendix III. A CMTS MUST be capable of processing the name fields of a certificate if the name fields conform to the indicated format in Appendix III. A CMTS MAY choose to accept a certificate that has name fields that do not conform to the indicated format in Appendix III.

The CMTS MUST process certificate extensions as defined by [RFC 5280] (see Appendix III.1 for certificate profile and extension definitions).

13.3.1 CMTS Certificate Management Model

The CMTS holds copies of the Root CA, Device CA (Mfg CA for legacy PKI) and CM Device Certificates (see Section 13.1), which it obtains through either provisioning or BPKM messaging. Each certificate learned by a CMTS MUST be assigned one of four states: Untrusted, Trusted, Chained, or Root. The CMTS MUST support the ability to provision at least two Root CA Certificates. The CMTS MUST support the ability to display the entire Root Certificate(s) and/or its thumbprint to the operator.

A CMTS learns of Device CA certificates through either the CMTS's provisioning interface or through receipt and processing of client CMs' Authentication Information messages. Regardless of how a CMTS obtains its Device CA certificates, the CMTS MUST mark them as either Untrusted, Trusted or Chained. If a CA Certificate is not self-signed, the CMTS MUST mark the certificate as Chained. The CMTS, however, MUST support administrative controls that allow an operator to override the Chained marking and identify a given CA certificate as Trusted or Untrusted.

If a Device CA Certificate is self-signed, the CMTS MUST mark the certificate as either Trusted or Untrusted, according to administratively controlled CMTS policy.

A CMTS obtains copies of CM Device Certificates in the Authorization Requests it receives from CMs. CM Device Certificates are issued by a Device CA. Thus, the CMTS MUST mark CM Device Certificates as Chained unless overridden by CMTS administrative control and configured as Trusted or Untrusted.

13.3.2 Certificate Validation

The CMTS validates the certification paths of CA and CM Device Certificates using Basic Path Validation rules defined in [RFC 5280] and the criteria below.

The CMTS MUST label CA and Cable Modem Certificates as Valid or Invalid if their certification paths are valid or invalid respectively. Trusted certificates, provisioned in the CMTS, MUST be Valid; this is true even if the current time does not fall within the Trusted certificate's validity period. Untrusted certificates, provisioned in the CMTS, MUST be Invalid.

The CMTS MUST mark a chained certificate as Valid only if:

1. The certificate chains to a Root CA, Trusted, or Valid certificate that has not been revoked as defined by the Basic Path Validation section in [RFC 5280]; and
2. The current time falls within the validity period of each Chained or Root certificate within the certificate chain; and
3. The certificate is not identified as revoked (see Section 13.4); and
4. In the case of a CM Device Certificate, the CM MAC address encoded in its tbsCertificate.subject field and RSA public key encoded on its tbsCertificate.subjectPublicKeyInfo field match the CM MAC address and RSA public key encoded in the Authorization Request's BPKM Attributes; and
5. In the case of a CM Device Certificate, if the KeyUsage extension is present, the digitalSignature and/or keyAgreement bits are turned on, the keyEncipherment bit is turned on, and the keyCertSign and cRLSign bits are off; in the case of a Device CA Certificate, if the KeyUsage extension is present, the keyCertSign bit is turned on.

Whether criterion 2 above is ignored MUST be subject to CMTS administrative control.

If validity period checking is enabled and the time of day has not been acquired by the CMTS, a (non-permanent) authorization reject message MUST be returned by the CMTS in response to an authorization request.

The CMTS MUST NOT invalidate certificates that have non-specified critical extensions (contrary to [RFC 5280]) as long as the certificates satisfy the validity criteria above.

13.4 Certificate Revocation

Providing a mechanism for certificate revocation is a normal part of PKI management. When a certificate is issued, it is expected to be in use for its entire validity period. However, various circumstances may cause a certificate to become invalid prior to the expiration of the validity period. Such circumstances include change of name, change of association between subject and CA, and compromise or suspected compromise of the corresponding private key. Under such circumstances, the CA needs to revoke the certificate. Two methods of supporting certificate revocation are defined in this specification: Certificate Revocation Lists (CRLs) and Online Certificate Status Protocol (OCSP). The CMTS MUST support configuration of none, one, or both certificate revocation methods to be enabled at the same time.

13.4.1 Certificate Revocation Lists

[RFC 5280] defines a method for revoking certificates using [X.509] Certificate Revocation Lists (CRLs).

Figure 13-1 shows a framework for managing and distributing CRLs. A CRL is a digitally signed, timestamped list of certificate serial numbers revoked by a Certificate Authority (CA). When a CA identifies the compromised certificates, the CA could generate the CRLs itself, or a CA could delegate the CRL generation to a third party CRL Issuer. The CRL Repository is a system that maintains a database of revoked certificates. The interface between the CA or CRL Issuer and the CRL Repository is outside the scope of this specification.

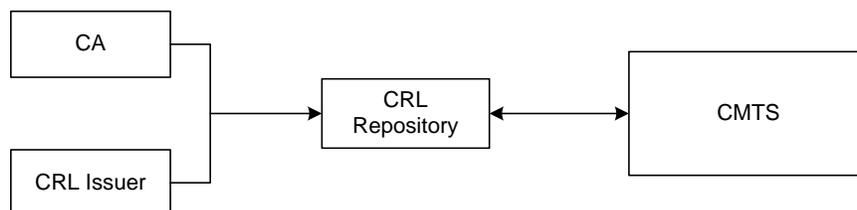

Figure 13-1 - CRL Framework

The CMTS retrieves CRL entries from the CRL Repository and uses this information to verify if a certificate received during the CM registration process is revoked.

13.4.1.1 CMTS CRL Support

The CMTS MUST support retrieval of CRL files formatted as defined in [RFC 5280]. CRL files may identify revoked certificates that were issued from different CAs. Therefore, the CMTS MUST support extensions related to indirect CRL files as defined in [RFC 5280]. The CMTS MUST support HTTP as defined in [RFC 2616] for downloading CRL files.

Before using the information in a CRL file, the CMTS MUST verify that its digital signature chains to a trusted root CA. Trusted root CAs are administratively provisioned in the CMTS. If the CRL file digital signature cannot be verified, the CMTS MUST discard the CRL file. The CMTS MUST validate if a CA certificate or CM Device Certificate is revoked during the certificate validation process specified in Section 13.3.2.

If the CRL contains the `nextUpdate` value the CMTS MUST refresh the CRL after the specified time has passed. If the CMTS fails to retrieve the new CRL, it MUST log an event [CCAP-OSSIV3.1] and continue to use its current CRL. If the CMTS fails to retrieve the new CRL it should attempt to retry retrieval of the CRL file on a periodic basis. If the CRL does not contain the `nextUpdate` value, the CMTS MUST refresh the CRL according to the configured value as defined in [CCAP-OSSIV3.1].

When the CMTS is configured to use a CRL it MUST attempt to retrieve the CRL file each time it starts up. During CMTS startup it is possible that some CMs may perform BPI+ authorization before the CRL file has been retrieved. When the CMTS is configured to use a CRL and a CM's device certificate chain is validated during CMTS startup before the CRL file is retrieved the CMTS MUST log an event for that CM [CCAP-OSSIV3.1] and bypass CRL checking.

13.4.2 Online Certificate Status Protocol

[RFC 6960] defines an Online Certificate Status Protocol (OCSP) for querying the status of a digital certificate. The CMTS sends a certificate status request to an OCSP responder when it receives a CA certificate or a CM Device Certificate (see Figure 13-2). The OCSP responder sends a status response indicating that the certificate is "good," "revoked," or "unknown." The OCSP responder checks only the revocation status of a certificate; it does not verify the validity of the certificate itself. The CMTS uses the result from the OCSP responder during certificate validation process specified in Section 13.3.2.

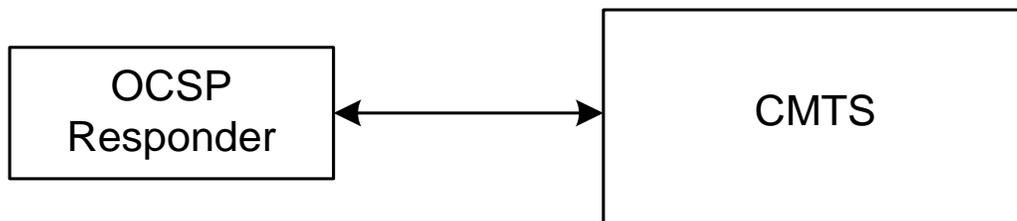

Figure 13-2 - OCSP Framework

The CMTS MUST be capable of acting as an OCSP client as defined in [RFC 6960]. The CMTS SHOULD cache the OCSP response status for a certificate if the `nextUpdate` value is present in the OCSP response. If the CMTS caches the OCSP response status for a given certificate, it MUST retrieve the revocation status from the cache. Once the `nextUpdate` time for that certificate has passed, the CMTS MUST continue using the revocation status value from the cache until an update is retrieved from the OCSP Responder.

If the CMTS is unable to retrieve the OCSP status for an uncached certificate or if the retrieved status is "unknown" the CMTS MUST log an event (see [CCAP-OSSIV3.1]) and assume the certificate status to be "good." If the `nextUpdate` value is not present in the OCSP response, the CMTS MUST NOT cache the OCSP response status for a certificate. If the CMTS is configured with OCSP Responder information, it MUST send an OCSP

request when a CA certificate or CM Device Certificate is obtained using the Authentication Information message, or Authentication Request message respectively, unless there is a valid certificate status in the cache.

When the CMTS is attempting to communicate with the OCSP Responder, the exchange should not significantly delay the CM provisioning process. If no response is received, the CMTS MUST proceed using the currently cached revocation status. For uncached certificate states, the CMTS MUST proceed as if a response with the status "good" has been received.

The CMTS MUST support OCSP over HTTP as described in [RFC 6960]. The CMTS MAY generate a signature in the OCSP request. The CMTS MUST bypass validation of the signature in an OCSP response based on the configured value as defined in [CCAP-OSSIV3.1].

14 SECURE SOFTWARE DOWNLOAD (SSD)

14.1 Introduction

DOCSIS supports downloading code to CMs. Authenticating the source and verifying the integrity of downloaded code is vital to the overall operation and security of DOCSIS-based networks. Code is signed with a certificate from the legacy PKI or new PKI (see Section 13.1) and then validated by the CM. Code signature and format requirements for the legacy PKI are defined in [DOCSIS SECv3.0].

The software download module is an attractive target for an attacker. If an attacker were able to mount a scalable attack against the software download module, he could potentially install code to disable all the CMs within a domain, or disrupt service on a wide scale. To thwart these attacks, the attacker is forced to overcome several security barriers.

14.2 Overview

The requirements defined in this section address these primary security goals for the code download process:

- The CM should have a means to authenticate that the originator of any download code is a known and trusted source;
- The CM should have a means to verify that the downloaded code has not been altered from the original form in which it was provided by the trusted source;
- The process should strive to simplify the operator's code file-handling requirements and provide mechanisms for the operator to upgrade or downgrade the code version of cable modems on their network;
- The process allows operators to dictate and control their policies with respect to: (a) which code files will be accepted by CMs within their network, and (b) security controls that define the security of the process on their network;
- CMs are able to move freely among systems controlled by different operators;
- Support updating the Root CA Certificate in the CM (optional);
- Support updating the Device CA Certificate in the CM (optional);
- Support updating the legacy Root CA Public Key in the CM (optional);
- Support updating the legacy Manufacturer CA Certificate in the CM (optional).

This document limits its scope to these primary system security requirements, but acknowledges that in some cases additional security may be desired. The concerns of individual operators or CM manufacturers may result in additional security related to the distribution or installation of code into a CM or other DOCSIS network element. This specification does not restrict the use of further protections, as long as they do not conflict with the requirements of this specification.

Multiple levels of protection are required to protect and verify the code download:

- The manufacturer of the CM code always applies a digital signature to the code file. The signature is verified with a certificate chain that extends up to the Root CA. The manufacturer signature affirms the source and integrity of the code file to the CM;
- Though the manufacturer always signs its code file, an operator may later apply its code signature in addition to the manufacturer signature. If a second signature is present, the CM verifies both signatures with a certificate chain that extends up to the Root CA before accepting a code file;
- OSS mechanisms for the provisioning and control of the CM are important to the proper execution of this process. The code-upgrade capability of a CM is enabled during the provisioning and registration process. Code downloads are initiated during the provisioning and registration process, or can be initiated in normal operation using an SNMP command.

The code file is built using a [PKCS#7]-compliant structure that is defined below. Included in this structure are:

- The code image; i.e., the upgrade code image;
- The Code Verification Signature (CVS); i.e., the digital signature over the code image and any other authenticated attributes as defined in the structure;
- The Code Verification Certificate (CVC); i.e., an [X.509]-compliant certificate that is used to deliver and validate the public code verification key that will verify the signature over the code image. The DOCSIS Certificate Authority, a trusted party whose public key is already stored in the CM, signs this certificate.

Figure 14-1 shows the basic steps required for the signing of a code image when the code file is signed only by the CM manufacturer, and when the code file is signed by the CM manufacturer and co-signed by an operator.

In DOCSIS, the Root CA certificate is installed in each CM as a trust anchor. The code manufacturer builds the code file by signing the code image using a DOCSIS PKCS#7 digital signature structure with a Mfr CVC certificate and the issuing CVC CA certificate. The code file is then sent to the operator.

The operator verifies that the code file is from a trusted DOCSIS manufacturer and has not been modified. At this point, the operator has the option of loading the code file on the software download server as-is, or of adding its signature and operator CVC and issuing CVC CA certificate to the code file. During the code upgrade process, the CM will retrieve the code file from the software download server and verify the new code image using the Root CA Certificate trust anchor before installing it. See Appendix III for CVC chain details.

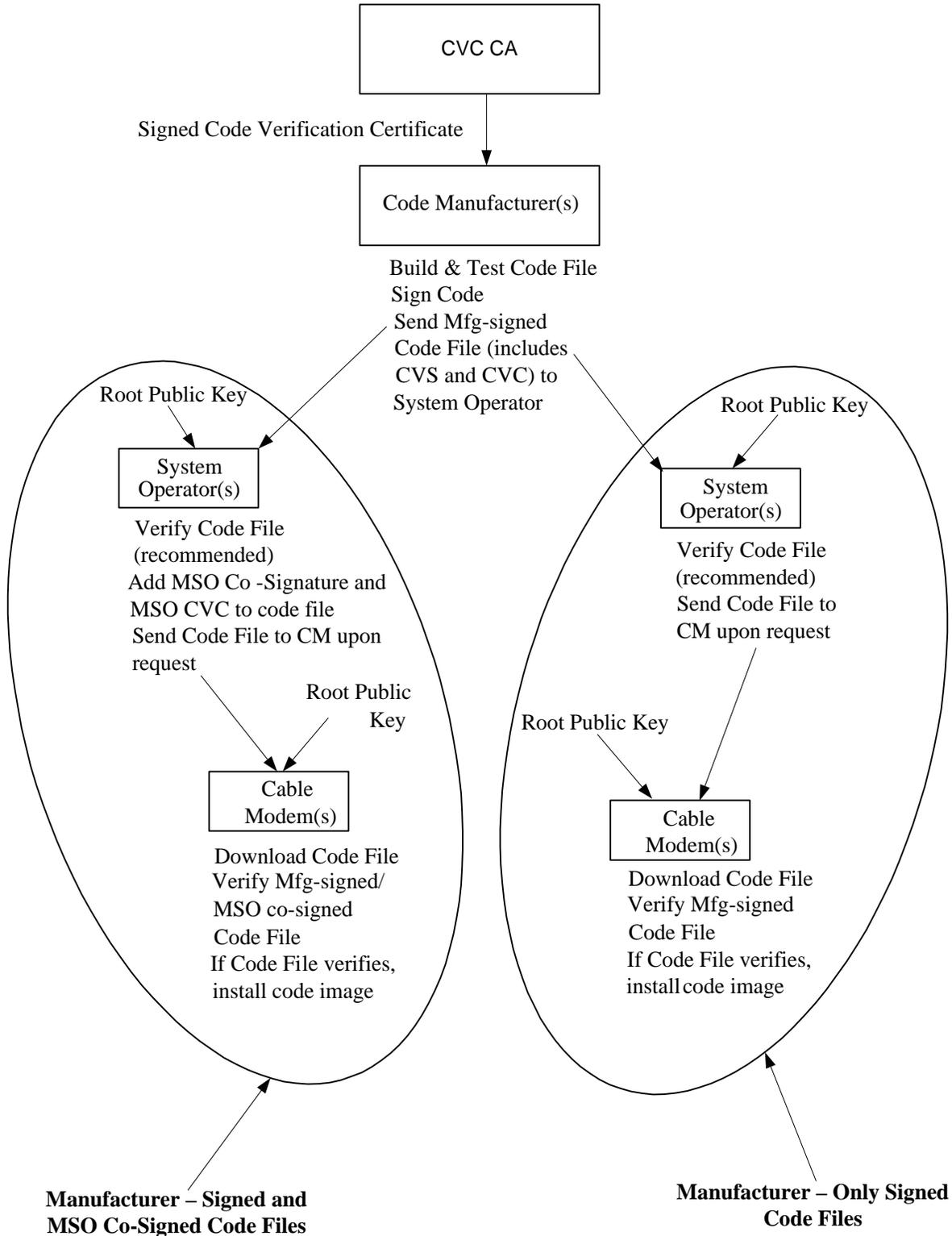

Figure 14-1 - Typical Code Validation Hierarchy

14.3 Software Code Upgrade Requirements

The following sections define requirements of the CM software code upgrade verification process. All DOCSIS 3.1 code upgrades are prepared and verified as described. All DOCSIS 3.1 CMs MUST verify code upgrades according to this specification regardless of whether Baseline Privacy is enabled or disabled. The new PKI used for issuing CVCs consists of three types of certificates: a Root CA, CVC CA, and the CVC. CableLabs manages the new PKI and the certificates issued from its CAs (CableLabs Root CA and CableLabs CVC CA; see Appendix III for certificate profile and extension definitions). The CM MUST process CVC extensions as defined by [RFC 5280]. Note: the CableLabs Root CA is used to issue both CM Device Certificates and CVC certificates. For backward compatibility, CMs MUST also support the code upgrade requirements that use the legacy PKI as defined in DOCSIS 3.0, unless stated otherwise in this specification.

14.3.1 Code File Processing Requirements

The code file format is defined in Appendix III.

The CM MUST reject the DOCSIS [PKCS#7] code file if the `signedData` field does not match the DER encoded structure represented in Appendix III.

The CM MUST be able to verify DOCSIS code file signatures that are signed using key modulus lengths of 1024, 1536, and 2048 bits. The public exponent is F_4 (65537 decimal).

The CM MUST reject the CVC if it does not match the DER encoded structure represented in Appendix III.

The CM MUST NOT install the upgraded code image unless the code image has been verified as being compatible with the CM.

If the code download and installation is successful, then the CM MUST replace its currently stored Root CA Certificate with the Root CA Certificate in the `SignedContent` field, if one was present.

If the code download and installation is successful, then the CM MUST replace its currently stored Device CA Certificate with the Device CA Certificate received in the `SignedContent` field, if any were present.

If the code download and installation is successful, then the CM MUST replace its currently stored legacy Manufacturer CA certificate with the legacy Manufacturer CA certificate received in the `SignedContent` field, if any were present.

14.3.2 Code File Access Controls

In addition to the cryptographic controls provided by the digital signature and the certificate, special control values are included in the code file for the CM to check before it accepts a code image as valid. The conditions placed on the values of these control parameters MUST be satisfied before the CM attempts to validate the CVC and the CVS (see Sections 14.3.2.1 and 14.3.2.2).

14.3.2.1 Subject Organization Names

The CM MUST recognize up to two names that it considers a trusted code-signing agent if present in the subject field of a code file CVC. These are:

- **The cable modem manufacturer:** The CM MUST verify that the manufacturer name in the `manufacturerCVC` subject field exactly matches the manufacturer name stored in the CM's non-volatile memory by the manufacturer. A manufacturer CVC is always included in the code file.
- **A co-signing agent:** As described above, DOCSIS permits another trusted organization to co-sign code files destined for the CM. In most cases this organization is the operator. The organization name of the co-signing agent is communicated to the CM via a co-signer CVC in the configuration file when initializing the CM's code verification process. The CM MUST verify that the co-signer organization name in the co-signer CVC subject field, exactly matches the co-signer organization name previously received in the co-signer initialization CVC, and stored by the CM.

14.3.2.2 Time Varying Controls

In support of the code upgrade process, the CM MUST keep two UTC time values associated with each code-signing agent. These values are known as `codeAccessStart` and `cvcAccessStart`. The CM MUST store and maintain one pair of time values for the CM manufacturer signing agent. If the CM is assigned a code co-signing agent, the CM MUST maintain a pair of time values for the code co-signing agent.

These values are used to control code file access to the cable modem by individually controlling the validity of the CVS and the CVC. Stored and maintained time values in the CM MUST have a precision of one second. Stored and maintained time values in the CM MUST be capable of representing all times (with one second precision) between midnight, Jan 1 1950, and midnight Jan 1 2050.

The CM MUST NOT allow the values of `codeAccessStart` and `cvcAccessStart` corresponding to the cable modem's manufacturer signing agent to decrease. The CM MUST NOT allow the value of `codeAccessStart` and `cvcAccessStart` corresponding to the co-signing agent to decrease as long as the co-signing agent does not change and the CM maintains the co-signer time-varying control values (see Section 14.3.3).

14.3.3 Cable Modem Code Upgrade Initialization

Before the cable modem can upgrade code, it should be properly initialized. Its manufacturer first initializes the cable modem. Every time a cable modem registers on a DOCSIS network, it MUST check its current initialization state with respect to the operational needs of the particular network. It may be necessary for the cable modem to reinitialize at registration, particularly if the cable modem has moved from one network to another.

14.3.3.1 Manufacturer Initialization

It is the responsibility of the manufacturer to install the initial code version in the CM.

In support of code upgrade verification, values for the following parameters MUST be loaded into the CM's non-volatile memory:

- CM manufacturer `organizationName`;
- REQ30766.2 `codeAccessStart` initialization value;
- `cvcAccessStart` initialization value.

The CM MUST initialize the values of `codeAccessStart` and `cvcAccessStart` to an `UTCTime` equal to the validity start time of the manufacturer's latest CVC. These values will be updated periodically under normal operation via manufacturer CVCs that are received and verified by the cable modem.

14.3.3.2 Network Initialization

The method for obtaining CM code download files is defined in [DOCSIS MULPIv3.1]. The CM receives settings relevant to code upgrade verification in its configuration file. The CM MUST NOT use these settings until after the CMTS has successfully registered the CM.

The configuration file normally includes the most up-to-date CVC applicable for the destination cable modem. When the configuration file is used to initiate a code upgrade, it will include a CVC to initialize the cable modem for accepting code files according to this specification. Regardless of whether a code upgrade is required, a CVC in the configuration file MUST be processed by the cable modem.

A configuration file may contain:

- No CVCs
- From legacy PKI:
 - A Manufacturer CVC (Type 32)
 - A Co-signer CVC (Type 33);
 - Both Manufacturer CVC and Co-signer CVC

- From DOCSIS 3.1 PKI:
 - A Manufacturer CVC Chain (the Manufacturer CVC and its issuing CA certificate (Type 81))
 - A Co-signer CVC Chain (the Co-signer CVC and its issuing CA certificate (Type 82))
 - Both Manufacturer CVC Chain and Co-signer CVC Chain

Before the CM will enable its ability to upgrade code files from the network, it MUST receive a valid CVC in a configuration file and successfully register with the CMTS. If the CM's configuration file does not contain a valid CVC and its ability to upgrade code files has been disabled, then the CM MUST reject any information in a CVC delivered via SNMP.

When the cable modem's configuration file does not contain a co-signer CVC, the CM MUST NOT accept code files that have been co-signed.

If the CM is configured to accept code co-signed by a code-signing agent, the following parameters MUST be stored in the CM's memory when the co-signer CVC is processed:

- Co-signing agent's `organizationName`;
- Co-signer `cvcAccessStart`;
- Co-signer `codeAccessStart`.

Unlike the manufacturer `organizationName` and time varying control values, the co-signer `organizationName` and time varying control values are not required to be stored in non-volatile memory.

14.3.3.2.1 Processing the Configuration File CVC

When a CVC is included in the configuration file, the CM MUST verify the CVC before accepting any of the code upgrade settings it contains. Upon receipt of the CVC the CM MUST perform the following validation and procedural steps. If any of the following verification checks fail, the CM MUST immediately halt the CVC verification process.

If the CM configuration file does not include a valid CVC, the CM MUST NOT download upgrade code files, whether triggered by the CM configuration file or via an SNMP MIB. If the CM configuration file does not include a valid CVC, the CM SHOULD NOT process CVCs subsequently delivered via an SNMP MIB. If the CM configuration file does not include a valid CVC, the CM MUST NOT accept information from a CVC subsequently delivered via an SNMP MIB.

Following receipt of a CVC in a configuration file, and after the CM has successfully registered with the CMTS, the CM MUST:

1. Verify that the Extended Key Usage extension is present in the CVC, as specified in Appendix III.
2. Verify that the manufacturer CVC validity start time is greater than or equal to the manufacturer `cvcAccessStart` value currently held in the CM if the CVC is a Manufacturer CVC and the subject `organizationName` is identical to the CM's manufacturer name.
3. Reject this CVC and log an error if the CVC is a Manufacturer CVC and the subject `organizationName` is not identical to the cable modem's manufacturer name.
4. Verify that the validity start time is greater than or equal to the co-signer `cvcAccessStart` value currently held in the CM if the CVC is a co-signer CVC and the subject `organizationName` is identical to the CM's current code co-signing agent.
5. After the CVC has been validated (and registration is complete), make this subject `organizationName` become the CM's new code co-signing agent if the CVC is a co-signer CVC and the subject `organizationName` is not identical to the current code co-signing agent name.
6. Verify that the CVC and any CVC CA Certificate signatures chain up to the Root CA Certificate of the new PKI or the Root CA key of the legacy PKI held by the CM.

7. If the CVC is issued from the new PKI, verify that the validity periods for the CVC and the issuing CA certificate have not expired.
8. Update the CM's current value of `cvcAccessStart` corresponding to the CVC's subject `organizationName` (i.e., manufacturer or code co-signing agent) with the validity start time value from the validated CVC. If the validity start time value is greater than the CM's current value of `codeAccessStart`, update the CM's `codeAccessStart` value with the validity start time value.

14.3.3.2.2 Processing the SNMP CVC

The CM MUST process CVCs received via SNMP when it is enabled to upgrade code files. When the CM is not enabled to upgrade code files it MUST reject all CVCs received via SNMP. CVCs received via SNMP will also chain up to the same Root CA certificate or public key that was used to validate the CVC in the configuration file (see Section 14.3.5). When validating a CVC received via SNMP, the CM MUST perform the following validation and procedural steps. If any of the following verification checks fail, the CM MUST immediately halt the CVC verification process, log the error if applicable, and remove all remnants of the process up to that step.

When a CM receives a CVC via SNMP, it MUST:

1. Verify that the Extended Key Usage extension is in the CVC as specified in Appendix III.
2. Verify that the manufacturer CVC validity start time is greater than the manufacturer `cvcAccessStart` value currently held in the CM if the CVC subject `organizationName` is identical to the CM's manufacturer name.
3. Verify that the validity start time is greater than the co-signer `cvcAccessStart` value currently held in the CM if the CVC subject `organizationName` is identical to the cable modem's current code co-signing agent.
4. Reject this CVC if the CVC subject `organizationName` is not identical to CM's manufacturer or current code co-signing agent name.
5. Verify that the CVC and any CVC CA Certificate signatures chain up to the same Root CA Certificate or Root CA key that was used to validate the corresponding CVC (manufacturer or co-signer) in the configuration file.
6. If the CVC is issued from the new PKI, verify that the validity periods for the CVC and the issuing CA certificate have not expired.
7. Update the current value of the subject's `cvcAccessStart` values with the validated CVC's validity start time value

If the validity start time value is greater than the CM's current value of `codeAccessStart`, the CM MUST replace its `codeAccessStart` value with the validity start value.

14.3.4 Code Signing Guidelines

Manufacturer and operator code signing guidelines are provided in Appendix III.

14.3.5 Code Verification Requirements

The CM MUST NOT install upgrade code unless the code has been verified.

14.3.5.1 Cable Modem Code Verification Steps

When downloading code, the CM MUST perform the verification checks presented in this section. If any of the verification checks fail, or if any section of the code file is rejected due to invalid formatting, the CM MUST immediately halt the download process and log the error if applicable, remove all remnants of the process to that step, and continue to operate with its existing code. The verification checks can be performed in any order.

1. The CM MUST verify that:
 - a) The value of `signingTime` is equal to or greater than the manufacturer `codeAccessStart` value currently held in the CM;
 - b) The value of `signingTime` is equal to or greater than the manufacturer CVC validity start time;

- c) The value of `signingTime` is less than or equal to the manufacturer CVC validity end time.
2. The CM MUST verify that:
 - a) The manufacturer CVC subject `organizationName` is identical to the manufacturer name currently stored in the CM's memory;
 - b) The manufacturer CVC validity start time is equal to or greater than the manufacturer `cvcAccessStart` value currently held in the CM;
 - c) The Extended Key Usage extension in the Manufacturer CVC meets the requirements of Appendix III.
3. The CM MUST verify that the Mfr CVC chains up to Root CA held by the CM.
4. If the CVC is issued from the new PKI, verify that the validity periods for the CVC and the issuing CA certificate have not expired.
5. The CM MUST verify the manufacturer code file signature. If the signature does not verify, the CM MUST reject all components of the code file (including the code image), and any values derived from the verification process should be immediately discarded.
6. If the manufacturer signature verifies and a co-signing agent signature is required:
 - a) The CM MUST verify that:
 - (1) The co-signer signature information is included in the code file;
 - (2) The value of `signingTime` is equal to or greater than the corresponding `codeAccessStart` value currently held in the CM;
 - (3) The value of `signingTime` is equal to or greater than the corresponding CVC validity start time;
 - (4) The value of `signingTime` is less than or equal to the corresponding CVC validity end time.
 - b) The CM MUST verify that:
 - (1) The co-signer CVC subject `organizationName` is identical to the co-signer organization name currently stored in the CM's memory;
 - (2) The co-signer CVC validity start time is equal to or greater than the `cvcAccessStart` value currently held in the CM for the corresponding subject `organizationName`;
 - (3) The Extended Key Usage extension in the co-signer CVC meets the requirements of Appendix III.
 - c) The CM MUST verify that the Co-Signing CVC Certificate chains up to the Root CA held by the CM.
 - d) If the CVC is issued from the new PKI, verify that the validity periods for the CVC and the issuing CA certificate have not expired.
 - e) The CM MUST verify the co-signer code file signature. If the signature does not verify, the CM MUST reject all components of the code file (including the code image), and any values derived from the verification process should be immediately discarded.
7. Once the manufacturer, and optionally the co-signer, signature has been verified, the code image can be trusted and installation may proceed. Before installing the code image, all other components of the code file and any values derived from the verification process except the [PKCS#7] `signingTime` values and the CVC validity start values SHOULD be immediately discarded.
8. The CM may upgrade its software by installing the code file according to [DOCSIS MULPIv3.1].
9. If the code installation is unsuccessful, the CM MUST discard the [PKCS#7] `signingTime` values and CVC validity start values it just received in the code file. The procedure for handling this failure condition is specified in [DOCSIS MULPIv3.1].
10. Once the code installation is successful, the CM MUST:
 - a) Update the current value of manufacturer `codeAccessStart` with the [PKCS#7] `signingTime` value;

- b) Update the current value of manufacturer `cvcAccessStart` with the CVC validity start value.
11. If the code installation is successful, and if the code file was co-signed, the CM MUST:
- a) Update the current value of the co-signer `codeAccessStart` with the [PKCS#7] `signingTime` value;
 - b) Update the current value of the co-signer `cvcAccessStart` with the CVC validity start value.

14.3.6 DOCSIS Interoperability

Images for DOCSIS 3.1 secure software download (SSD) are to be signed using certificates from the new PKI defined in this specification. Images for legacy secure software download are signed using certificates from the legacy PKI defined in [DOCSIS SECv3.0]. The CM supports secure software downloads using certificates from either the new PKI or the legacy PKI.

The CM determines the version of the PKI based on the contents of the CM's configuration file. If the configuration file contains a Manufacturer CVC Chain and/or a Co-signer CVC Chain, the CM MUST perform DOCSIS 3.1 secure software download, regardless of the presence of the legacy Manufacturer or Co-signer CVC. If the configuration file contains a legacy Manufacturer CVC and/or a Co-signer CVC and no DOCSIS 3.1 Manufacturer CVC Chain or Co-signer CVC Chain, the CM MUST perform legacy secure software download.

14.3.7 Error Codes

The CM MUST log the following error events when they occur during the code verification process. DOCSIS event logging requirements and event message format are defined in [DOCSIS CM-OSSiv3.1]:

1. Improper code file controls

Conditions:

- a) CVC subject `organizationName` for manufacturer does not match the CM's manufacturer name.
 - b) CVC subject `organizationName` for code co-signing agent does not match the CM's current code co-signing agent.
 - c) The manufacturer [PKCS#7] `signingTime` value is less-than the `codeAccessStart` value currently held in the CM.
 - d) The manufacturer [PKCS#7] validity start time value is less-than the `cvcAccessStart` value currently held in the CM.
 - e) The manufacturer CVC validity start time is less-than the `cvcAccessStart` value currently held in the CM.
 - f) The manufacturer [PKCS#7] `signingTime` value is less-than the CVC validity start time.
 - g) Missing or improper extended key-usage extension in the manufacturer CVC.
 - h) The co-signer [PKCS#7] `signingTime` value is less-than the `codeAccessStart` value currently held in the CM.
 - i) The co-signer [PKCS#7] validity start time value is less-than the `cvcAccessStart` value currently held in the CM.
 - j) The co-signer CVC validity start time is less-than the `cvcAccessStart` value currently held in the CM.
 - k) The co-signer [PKCS#7] `signingTime` value is less-than the CVC validity start time.
 - l) Missing or improper extended key-usage extension in the co-signer CVC.
- ##### 2. Code file manufacturer CVC validation failure

Conditions:

- a) The manufacturer CVC in the code file does not chain to the same root CA as the manufacturer CVC in the configuration file.

3. Code file manufacturer CVS validation failure
4. Code file co-signer CVC validation failure
 - a) The co-signer CVC in the code file does not chain to the same root CA as the co-signer CVC in the configuration file.
5. Code file co-signer CVS validation failure
6. Improper configuration file CVC format
 - a) Missing or improper key usage attribute.
7. Configuration file CVC validation failure
8. Improper SNMP CVC format

Conditions:

- a) CVC subject organizationName for manufacturer does not match the CM's manufacturer name,.
 - b) CVC subject organizationName for code co-signing agent does not match the CM's current code co-signing agent,
 - c) The CVC validity start time is less-than or equal-to the corresponding subject's cvcAccessStart value currently held in the CM.
 - d) Missing or improper key usage attribute.
9. SNMP CVC validation failure

Conditions:

- a) The manufacturer CVC received via SNMP does not chain to the same root CA as the manufacturer CVC in the configuration file.
- b) The co-signer CVC received via SNMP does not chain to the same root CA as the co-signer CVC in the configuration file.

14.4 Security Considerations (Informative)

The method(s) used to protect private keys are a critical factor in maintaining security. Users authorized to sign code, i.e., manufacturers and operators who have been issued code verification certificates (CVCs) by the DOCSIS root CA, should protect their private keys. An attacker with access to the private key of an authorized code-signing user can create, at will, code files that are potentially acceptable to a large number of CMs.

The defense against such an attack is for the operator to revoke the certificate whose associated code-signing private key has been learned by the attacker. To revoke a certificate, the operator delivers to each affected CM, an updated CVC with a validity start time that is newer than that of the certificate(s) being revoked. The new CVC can be delivered via any of the supported mechanisms: configuration file, code file, or SNMP. The new CVC implicitly revokes all certificates whose validity start time is earlier than that of the new CVC.

To reduce the vulnerability to this type of attack, operators should regularly update the CVC in each CM, at a frequency comparable to how often the operator would update a CRL if one were available. Regular updates help manage the time interval during which a compromised code-signing key is useful to an attacker. CVCs should also be updated if it is suspected that a code-signing key has been compromised. To update the CVC, the user needs a CVC whose validity start time is newer than the CVC in the CM. This implies that the DOCSIS root CA regularly issues new CVCs to all authorized code-signing manufacturers and operators, to make the CVCs available for update.

When a CM is attempting to register on the network for the first time or after being off-line for an extended period, it should receive a trusted CVC as soon as possible. This provides the CM with the opportunity to receive the most up-to-date CVC available and deny access to CVCs that needed to be revoked since the CM last initialization. The first opportunity for the CM to receive a trusted CVC is in its configuration file. If the configuration file does not

include a valid CVC, the CM will not request or have the ability to remotely upgrade code files. In addition, the CM will not accept CVCs subsequently delivered via SNMP.

To mitigate the possibility of a CM receiving a previous code file via a replay attack, the code files include a signing-time value in the [PKCS#7] structure that can be used to indicate the time the code image was signed. When the CM receives a code file signing-time that is later than the signing-time it last received, it will update its internal memory with this value. The CM will not accept code files with an earlier signing-time than this internally stored value. To upgrade a CM with a new code file without denying access to past code files, the signer may choose not to update the signing-time. In this manner, multiple code files with the same code signing-time allow an operator to freely downgrade a CM's code image to a past version (that is, until the CVC is updated). This has a number of advantages for the operator, but these advantages should be weighed against the possibilities of a code file replay attack.

Without a reliable mechanism to revert back to a known good version of code, any code-update scheme, including the one in this specification, has the weakness that a single, successful forced update of an invalid code image may render the CM useless, or may cause the CM to behave in a manner harmful to the network. Such a CM may not be repairable via a remote code update, since the invalid code image may not support the update scheme.

Annex A TFTP Configuration File Extensions (Normative)

A CM's security configuration parameters are included in the CM configuration file that is downloaded from a TFTP server [DOCSIS MULPIv3.1].

A.1 Encodings

The following type/length/value encodings are used for security configuration settings included in the configuration file. The security configuration settings in the RF MAC CM registration requests MUST be bitwise identical to those included in the configuration file. All multi-octet quantities are in network-byte order, i.e., the octet containing the most-significant bits is the first transmitted on the wire.

A.1.1 Baseline Privacy Configuration Setting

The combination of Privacy Enable configuration setting [DOCSIS MULPIv3.1] and the Privacy Support Modem Capability Setting [DOCSIS MULPIv3.1] controls whether Baseline Privacy Plus is enabled or disabled in a CM. If the operator intends to provision a CM to operate in BPI+ mode using the default BPI Configuration Parameter(s) specified in Table A-1, the corresponding Baseline Privacy Configuration subset(s) in the configuration file may be omitted. If the configuration file does not contain all the necessary BPI+ parameters, the CM MUST use the default value(s) specified in Table A-1 for the missing parameter(s). On the other hand, if the operator intends to provision a CM to operate in BPI+ mode using the BPI Configuration Parameter(s) different from the default value(s) in Table A-1, the corresponding Baseline Privacy Configuration subset(s) are present. The Baseline Privacy Configuration setting may be present if Baseline Privacy Plus is disabled. The separate Privacy Enable parameter allows an operator to disable or re-enable Baseline Privacy by toggling a single configuration parameter.

This field defines the parameters associated with Baseline Privacy operation. It is composed of a number of encapsulated type/length/value fields. The type fields defined are only valid within the encapsulated Baseline Privacy configuration setting string.

Type	Length	Value
BP_CFG	n	

[DOCSIS MULPIv3.1] defines the specific value of BP_CFG.

A.1.1.1 Internal Baseline Privacy Encodings

A.1.1.1.1 Authorize Wait Timeout

The value of this field specifies the retransmission interval, in seconds, of Authorization Request messages when in the Authorize Wait state.

Subtype	Length	Minimum Value	Maximum Value
1	4	1	30

A.1.1.1.2 Reauthorize Wait Timeout

The value of this field specifies the retransmission interval, in seconds, of Authorization Request messages when in the ReAuthorize Wait state.

Subtype	Length	Minimum Value	Maximum Value
2	4	1	30

A.1.1.1.3 Authorization Grace Time

The value of this field specifies the grace period for reauthorization, in seconds.

Subtype	Length	Minimum Value	Maximum Value
3	4	1	6,047,999

A.1.1.1.4 Operational Wait Timeout

The value of this field specifies the retransmission interval, in seconds, of Key Requests when in the Operational Wait state.

Subtype	Length	Minimum Value	Maximum Value
4	4	1	10

A.1.1.1.5 Rekey Wait Timeout

The value of this field specifies the retransmission interval, in seconds, of Key Requests when in the Rekey Wait state.

Subtype	Length	Minimum Value	Maximum Value
5	4	1	10

A.1.1.1.6 TEK Grace Time

The value of this field specifies grace period, in seconds, for re-keying the TEK.

Subtype	Length	Minimum Value	Maximum Value
6	4	1	302,399

A.1.1.1.7 Authorize Reject Wait Timeout

The value of this field specifies how long, in seconds, a CM waits in the Authorize Reject Wait state after receiving an Authorization Reject.

Subtype	Length	Minimum Value	Maximum Value
7	4	1	600

A.1.1.1.8 SA Map Wait Timeout

The value of this field specifies the retransmission interval, in seconds, of SA Map Requests when in the Map Wait state.

Subtype	Length	Minimum Value	Maximum Value
8	4	1	10

A.1.1.1.9 SA Map Max Retries

The value of this field specifies the maximum number of Map Request retries.

Subtype	Length	Minimum Value	Maximum Value
9	4	0	10

A.2 Parameter Guidelines

Below are recommended ranges and values for Baseline Privacy's various configuration and operational parameters. These ranges and default values may change as service providers gain operational experience running Baseline Privacy.

Table A-1 - Recommended Operational Ranges for BPI Configuration Parameters

System	Name	Description	Minimum Value	Default Value	Maximum Value
CMTS	Authorization Lifetime	Lifetime, in seconds, CMTS assigns to new Authorization Key	1 day (86400 sec.)	7 days (604800 sec.)	70 days (6048000 sec.)
CMTS	TEK Lifetime	Lifetime, in seconds, CMTS assigns to new TEK	30 min. (1800 sec.)	12 hours (43200 sec.)	7 days (604800 sec.)
CM	Authorize Wait Timeout	Auth Req retransmission interval from Auth Wait state	2 sec.	10 sec.	30 sec.
CM	Reauthorize Wait Timeout	Auth Req retransmission interval from Reauth Wait state	2 sec.	10 sec.	30 sec.
CM	Authorization Grace Time	Time prior to Authorization expiration CM begins re-authorization	5 min. (300 sec.)	10 min. (600 sec.)	35 days (3024000 sec.)
CM	Operational Wait Timeout	Key Req retransmission interval from Op Wait state	1 sec.	10 sec.	10 sec.
CM	Rekey Wait Timeout	Key Req retransmission interval from Rekey Wait state	1 sec.	10 sec.	10 sec.
CM	TEK Grace Time	Time prior to newer TEK expiration CM begins re-keying	5 min. (300 sec)	1 hour (3600 sec.)	3.5 days (302399 sec)
CM	Authorize Reject Wait	Delay before re-sending Auth Request after receiving Auth Reject	10 sec.	60 sec.	10 min. (600 sec.)
CM	SA Map Wait Timeout	Map Request retransmission interval from Map Wait state	1 sec.	1 sec.	10 sec.
CM	SA Map Max Retries	Maximum number of times CM retries SA Map Request before giving up	0	4	10

The valid range (vs. recommended operational range) for Authorization and TEK lifetimes are:

- Authorization Lifetime Valid Range: 1 - 6048000 seconds
- TEK Lifetime Valid Range: 1 - 604800 seconds

The CMTS MUST support the valid range for Authorization and TEK lifetimes. The CM MUST support the valid range for Authorization and TEK lifetimes.

Annex B TFTP Options (Normative)

Network Working Group
Internet-Draft
Expires: December 1, 2006

S. Zeng
Cisco Systems, Inc.
D. R. Evans
ARRIS International, Inc.
May 30, 2006

Hardware and Network Address Options for TFTP
draft-evans-tftp-address-options-01.txt

Status of this Memo

By submitting this Internet-Draft, each author represents that any applicable patent or other IPR claims of which he or she is aware have been or will be disclosed, and any of which he or she becomes aware will be disclosed, in accordance with Section 6 of BCP 79.

Internet-Drafts are working documents of the Internet Engineering Task Force (IETF), its areas, and its working groups. Note that other groups may also distribute working documents as Internet-Drafts.

Internet-Drafts are draft documents valid for a maximum of six months and may be updated, replaced, or obsoleted by other documents at any time. It is inappropriate to use Internet-Drafts as reference material or to cite them other than as "work in progress."

The list of current Internet-Drafts can be accessed at
<http://www.ietf.org/ietf/lid-abstracts.txt>.

The list of Internet-Draft Shadow Directories can be accessed at
<http://www.ietf.org/shadow.html>.

This Internet-Draft will expire on December 1, 2006.

Copyright Notice

Copyright (C) The Internet Society (2006).

Abstract

The Hardware Address and Network Address options carry the hardware address and network address respectively of a client device that performs a Trivial File Transfer Protocol (TFTP) request.

Zeng & Evans

Expires December 1, 2006

[Page 1]

Internet-Draft

TFTP Address Options

May 2006

1. Introduction

The Trivial File Transfer Protocol [2] (TFTP) is a simple protocol that allows a client to read a file from, or write a file to, a remote server.

In some networks, a proxy relays requests and responses between a TFTP client and a TFTP server. A router may also be present between the client and the server. In these cases, addressing information that identifies the client and that may be required by the server for authentication, file-generation or other purposes may not be readily available to the server. The options defined in this document allow the client or the proxy to provide the needed address(es) to the server.

An example of such a network would be one in which a large service provider deploys end-user devices that are provisioned using TFTP. The service provider might use the MAC address or the IP address of the end-user device in order to create a provisioning file for that particular device, or as keys in an internal database of end-user devices. However, if the TFTP request passes through a router, the MAC address of the end-user device is no longer available to the TFTP server. Similarly, if the request is proxied through an edge-of-network device the IP address of the end-user device can be unavailable to the TFTP server. By using the options defined in this document, the MAC and/or IP address(es) of the end-user device can be made available to the server.

The general mechanism used for adding options to TFTP messages is described in [4].

2. Use of TFTP

[6] discourages the use of TFTP, and cites several reasons for doing so. We similarly discourage use of the protocol. However, there are strictly limited scenarios in which it might be reasonable to deploy it. In particular, operators that support systems with a large deployed base and in which explicit steps have taken to address the security and other concerns of [6] may wish to continue to use TFTP. The options described in this document should be used only in such systems.

3. Terminology

The key words MUST, MUST NOT, REQUIRED, SHALL, SHALL NOT, SHOULD, SHOULD NOT, RECOMMENDED, MAY, and OPTIONAL in this document are to be

Zeng & Evans

Expires December 1, 2006

[Page 2]

Internet-Draft

TFTP Address Options

May 2006

interpreted as described in [3].

4. Format of the Hardware Address option

The TFTP Read Request or Write Request packet is modified to include the hwaddr option. All named fields except "opc" are followed by a single-octet field containing the value zero.

```

+-----+-----+-----+-----+-----+-----+-----+-----+
|  opc  |filename| 0  |  mode  | 0  | hwaddr | 0  |   ha   | 0  |
+-----+-----+-----+-----+-----+-----+-----+-----+

```

opc	The opcode field contains either a 1, for Read Requests, or 2, for Write Requests, as defined in [2].
filename	The name of the file to be read or written, as defined in [2].
mode	The mode of the file transfer: "netascii", "octet", or "mail", as defined in [2].
hwaddr	The Hardware Address option, containing the case-insensitive string "hwaddr" in ASCII.
ha	A hardware address. The format of hardware addresses is defined in Section 5.

5. Format of the Hardware Address

A hardware address comprises two comma-separated ASCII fields: hardware type and the address value.

hardware type	A number representing the type of the hardware address. This document defines a single value, "1", representing an Ethernet address.
address value	A representation of the hardware address. This document defines a single format, to be used in the case that the hardware type has the value "1". In this case, that address MUST be an Ethernet MAC address in the case-insensitive form "xx:xx:xx:xx:xx:xx".

6. Format of the Network Address option

The TFTP Read Request or Write Request packet is modified to include the netaddr option. All named fields except "opc" are followed by a single-octet field containing the value zero.

Zeng & Evans

Expires December 1, 2006

[Page 3]

Internet-Draft

TFTP Address Options

May 2006

```
+-----+-----+-----+-----+-----+-----+-----+-----+
|  opc  |filename| 0  |  mode  | 0  | netaddr| 0  |  na   | 0  |
+-----+-----+-----+-----+-----+-----+-----+-----+
```

opc The opcode field contains either a 1, for Read Requests, or 2, for Write Requests, as defined in [2].

filename The name of the file to be read or written, as defined in [2].

mode The mode of the file transfer: "netascii", "octet", or "mail", as defined in [2].

netaddr The Network Address option, containing the case-insensitive string "netaddr" in ASCII.

na A network address. The format of network addresses is defined in Section 7.

7. Format of the Network Address

A network address comprises two comma-separated ASCII fields: network type and the address value.

network type A number representing the type of the network address. This document defines two values: "1" represents an IPv4 address; "2" represents an IPv6 address.

address value A representation of the network address. This document defines two formats. If the network type has the value "1", the network address MUST be a dotted decimal IPv4 address as defined in [1]. If the network type has the value "2", the network address MUST be a case-insensitive IPv6 address in one of the formats specified by section 2.2 of [5].

8. Option Acknowledgement

[4] allows for the possibility that TFTP options will be acknowledged explicitly with an OACK packet. A TFTP server SHOULD NOT respond to the presence of a valid Hardware Address option or Network Address option by sending an OACK as defined in [4].

9. Errors

[4] allows for the possibility that TFTP options will contain errors.

Zeng & Evans

Expires December 1, 2006

[Page 4]

Internet-Draft

TFTP Address Options

May 2006

For the options defined in this document, the server SHOULD return a TFTP ERROR message with ErrorCode value 8 if any of the following occurs:

1. An error when parsing an option;
2. An unknown hardware or network type;
3. An incorrectly formatted hardware or network address.

10. Security Considerations

TFTP provides no security safeguards; it relies on other layers to provide appropriate security where necessary. This document does not introduce any additional safeguards into TFTP. In the absence of other security measures, several possibilities exist for inappropriate behaviour:

- o A client could populate the options defined in this document with incorrect but legal values. This could cause the TFTP server to behave in an undesirable manner (for example, it might report an incorrect hardware address to a backoffice system). This hazard can be circumvented by having a trusted device between the client and the server check and/or overwrite the values in the option fields.
- o An attacker could replace correct option values with incorrect ones. This could cause the TFTP server to behave in an undesirable manner (for example, it might report an incorrect hardware address to a backoffice system).
- o An attacker could insert legal but incorrect option values into a request that originally did not use the options defined in this document. This could cause the TFTP server to behave in an undesirable manner (for example, it might report an incorrect hardware address to a backoffice system).
- o An attacker could return an ERROR message to the client even though there was no error in the request. This causes the requested transfer not to occur.
- o An attacker could insert an option acknowledgement into a reply that did not originally contain that option. This results in undefined behaviour at the client.

Systems can take various steps to thwart these attacks. In general, TFTP should be used only on networks that provide either physical protection against attack or supports features such as client authentication and encryption of traffic between the client and server. The same features that allow TFTP to be used securely will generally thwart the above attacks. For example, all but the first attacks above are Man-in-the-Middle (MitM) attacks. These MitM attacks can be thwarted by properly encrypting the messages. Proper message encryption ensures that a potential attacker cannot perform any attacks that involve altering the values of the option fields.

Zeng & Evans

Expires December 1, 2006

[Page 5]

Internet-Draft

TFTP Address Options

May 2006

11. IANA Considerations

This document has no actions for IANA.

12. References

12.1. Normative References

- [1] Kirkpatrick, S., Stahl, M., and M. Recker, "Internet numbers", RFC 1166, July 1990.
- [2] Sollins, K., "The TFTP Protocol (Revision 2)", STD 33, RFC 1350, July 1992.
- [3] Bradner, S., "Key words for use in RFCs to Indicate Requirement Levels", BCP 14, RFC 2119, March 1997.
- [4] Malkin, G. and A. Harkin, "TFTP Option Extension", RFC 2347, May 1998.
- [5] Hinden, R. and S. Deering, "Internet Protocol Version 6 (IPv6) Addressing Architecture", RFC 3513, April 2003.

12.2. Informative References

- [6] Lear, E., "Uniform Resource Identifier (URI) Scheme and Applicability Statement for the Trivial File Transfer Protocol (TFTP)", RFC 3617, October 2003.

Zeng & Evans

Expires December 1, 2006

[Page 6]

Internet-Draft

TFTP Address Options

May 2006

Authors' Addresses

Shengyou Zeng
Cisco Systems, Inc.
1414 Massachusetts Avenue
Boxborough, MA 01719
USA

Phone: +1 978.936.1609
Email: szeng@cisco.com

D. R. Evans
ARRIS International, Inc.
7912 Fairview Road
Boulder, CO 80303
USA

Phone: +1 303.494.0394
Email: N7DR@arrisi.com

Zeng & Evans

Expires December 1, 2006

[Page 7]

Internet-Draft

TFTP Address Options

May 2006

Intellectual Property Statement

The IETF takes no position regarding the validity or scope of any Intellectual Property Rights or other rights that might be claimed to pertain to the implementation or use of the technology described in this document or the extent to which any license under such rights might or might not be available; nor does it represent that it has made any independent effort to identify any such rights. Information on the procedures with respect to rights in RFC documents can be found in BCP 78 and BCP 79.

Copies of IPR disclosures made to the IETF Secretariat and any assurances of licenses to be made available, or the result of an attempt made to obtain a general license or permission for the use of such proprietary rights by implementers or users of this specification can be obtained from the IETF on-line IPR repository at <http://www.ietf.org/ipr>.

The IETF invites any interested party to bring to its attention any copyrights, patents or patent applications, or other proprietary rights that may cover technology that may be required to implement this standard. Please address the information to the IETF at ietf-ipr@ietf.org.

Disclaimer of Validity

This document and the information contained herein are provided on an "AS IS" basis and THE CONTRIBUTOR, THE ORGANIZATION HE/SHE REPRESENTS OR IS SPONSORED BY (IF ANY), THE INTERNET SOCIETY AND THE INTERNET ENGINEERING TASK FORCE DISCLAIM ALL WARRANTIES, EXPRESS OR IMPLIED, INCLUDING BUT NOT LIMITED TO ANY WARRANTY THAT THE USE OF THE INFORMATION HEREIN WILL NOT INFRINGE ANY RIGHTS OR ANY IMPLIED WARRANTIES OF MERCHANTABILITY OR FITNESS FOR A PARTICULAR PURPOSE.

Copyright Statement

Copyright (C) The Internet Society (2006). This document is subject to the rights, licenses and restrictions contained in BCP 78, and except as set forth therein, the authors retain all their rights.

Acknowledgment

Funding for the RFC Editor function is currently provided by the Internet Society.

Zeng & Evans

Expires December 1, 2006

[Page 8]

Annex C DOCSIS 1.1/2.0 Dynamic Security Associations (Normative)

C.1 Introduction

To be backward compatible, DOCSIS 3.0 CMs MUST support the Dynamic Security Association functionality defined in this Annex when operating in DOCSIS 1.1 or 2.0 modes. Dynamic Security Associations (Dynamic SAs) are SAs that a CMTS establishes and eliminates dynamically, in response to its enabling and disabling of downstream traffic flows that require DOCSIS security. These traffic flows may be initiated by the actions of:

- A CPE device attached to one of the CMTS's client CMs;
- An application server within the head-end;
- An OSS;
- Other unspecified mechanisms.

Regardless of what triggers the establishment of a Dynamic SA within the CMTS, client CMs need a mechanism for learning the mapping of a particular secured downstream traffic flow to that flow's SAID. The SA Mapping state machine, defined in this section, defines how CMs query a CMTS for that mapping. This state machine controls the transmission of SA Map Request messages to a CMTS.

A CMTS can establish or eliminate Dynamic SAs in response to changes in IP group membership of downstream CPE devices. IGMP management can cause the CMTS to establish Dynamic SAs. When in MDF-Disabled Mode (see [DOCSIS MULPIv3.1]), if the CM detects IGMPv2 (see [RFC 3376]) join messages, the CM MUST trigger Map Request messages that query the CMTS for the mapping of the IP multicast group address contained in the IGMPv2 join message to an SA.

The SA mapping mechanism may map an IP multicast group to a Static SA or to a particular CM's Primary SA; thus, a CMTS's response to a mapping request may return any of the three types of SAs. The SA mapping mechanism, however, is the only mechanism by which a CM can learn the identity of Dynamic SAs.

C.2 Theory of Operation

Three BPKM messages support SA mappings: SA Map Request, SA Map Reply and SA Map Reject. A CM sends a Map Request to request the mapping of a known downstream flow to a SA. The Map Request carries attributes identifying the requesting CM and the downstream traffic flow whose SA mapping is being requested.

The CMTS MUST respond to a Map Request with either:

- A Map Reply, providing the CM with the requested SA mapping; or
- A Map Reject, signaling to the CM that either:
 - The CM is not authorized to receive the traffic flow identified in the Map Request; or
 - The requested traffic flow is not mapped to an SA.

If the CM does not receive either of these responses within a configurable retry timeout period, it re-sends the Map Request. If no response is received after a configurable maximum number of retries, the CM terminates the request.

If the CM receives a Map Reject, it ceases all further attempts to obtain the mapping. In the case where access to the downstream traffic flow is mapped to an SA and the requesting CM is not authorized access for that SA, the CM will be denied access because the CM cannot obtain keying material needed to decrypt the downstream traffic flows encrypted under that SA. In the case where the requested traffic flow is not encrypted (i.e., it is not mapped to an SA), the unencrypted traffic will simply be forwarded to the attached CPE device.

If the CM receives a Map Reply identifying the SA associated with the requested downstream traffic flow, the CM launches a TEK state machine for the SA, provided that:

- The CM is not already running a TEK state machine for that SA; and

- The CM supports the cryptographic suite and SAID identified in the Map Reply.

The CM may already be running a TEK state machine if the mapped SA is:

- A Dynamic SA mapped to another protected traffic flow to which the CM already has access;
- The requesting CM's Primary SA;
- A previously-learned Static SA.

The Map Reply includes an SA-Descriptor attribute that identifies both a SAID and the cryptographic suite employed by the SA. As with Static SAs, a CMTS MAY respond to a Map Request with an SA (either Static or Dynamic) that employs a cryptographic suite that the requesting CM does not support. The CM MUST NOT start TEK state machines for SAs whose cryptographic suites the CM does not support.

The TEK state machine controls the retrieval of the mapped SA's keying material.

Receipt of a Key Reject forces the termination of the TEK state machine.

There are two mechanisms for the CMTS to inform a client CM that it is not authorized to access a particular traffic flow:

1. Responding to a Map Request with a Map Reject, and
2. Responding to a Key Request with a Key Reject.

The CMTS SHOULD check a CM's authorization status prior to responding to a Map Request and, if the CM is not authorized to receive the traffic, respond with a Map Reject. By performing this check during the mapping exchange, a CM will be prevented from needlessly launching a TEK state machine and sending a Key Request for a SAID for which it is not authorized.

C.3 SA Mapping State Model

The SA Mapping state model specifies the mechanism by which a CM learns the mapping between a traffic flow and a Dynamic SA.

An SA Mapping state machine is started when an event, external to the SA Mapping State Model, triggers the need for a traffic-flow-to-SA mapping. This external event generates an internal {Map} event in the SA Mapping state machine.

The state machine is terminated if the CM receives no response after sending the maximum number of retries, or when the CM determines that it no longer requires the mapped SA's keying material. In the latter case, an external event sends an internal {Unmap} event to the SA Mapping state machine, forcing its termination. The CM MAY implement the {Unmap} event.

The SA Mapping state machine is presented as a state flow model (Figure C-1) and as a state transition matrix (Table C-1). The CM MUST use the state transition matrix and its associated text as the definitive specification of protocol actions associated with each state transition. A shaded cell within the state transition matrix implies that either the specific event should not occur within that state; if the event does occur, the CM MUST NOT transition to another state.

When a CM requires access to a Dynamic SA's keying material, it establishes a TEK state machine for that Dynamic SA. While the Authorization state machine controls the establishment and termination of TEK state machines associated with Primary and Static SAIDs, it does not control the establishment and termination of TEK state machines associated with Dynamic SAs.

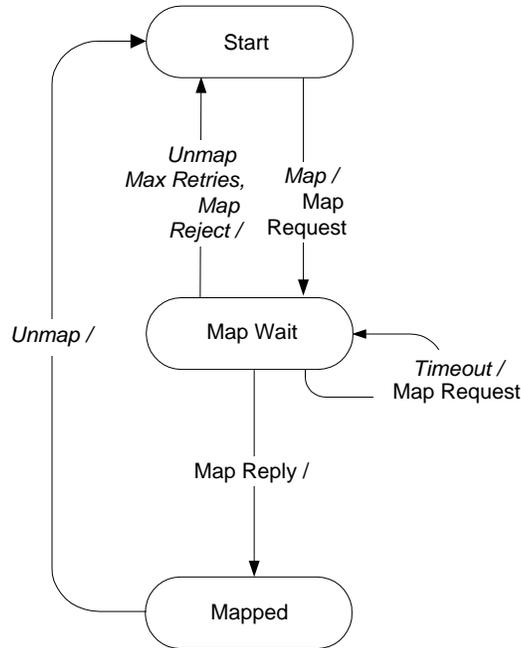

Figure C-1 - SA Mapping State Machine Flow Diagram

Table C-1 - Dynamic SAID State Transition Matrix

State Event or Rcvd Message	[Start]	[Map Wait]	[Mapped]
{Map}	[Map Wait]		
{Unmap}		[Start]	[Start]
{Map Reply}		[Mapped]	
{Map Reject}		[Start]	
{Timeout}		[Map Wait]	
{Max Retries}		[Start]	

Brief Description of States

[Start]

The initial state of the FSM.

[Map Wait]

The CM has sent the CMTS a Map Request and is waiting for a response.

[Mapped]

The CM has received a Map Reply and learned the requested SA mapping.

Brief Description of Messages

Map Request

Sent by CM to CMTS to request a SA mapping.

Map Reply

Positive CMTS response to a Map Request; contains the requested SA mapping.

Map Reject

Negative CMTS response to a Map Request; signals to the CM that either:

- The CM is not authorized access to the traffic flow identified in the Map Request; or
- The requested traffic flow is not mapped to an SA.

Brief Description of Events

{Map}

Triggers the start of the SA Mapping state machine. The {Map} event is linked to a CM event not defined by this specification.

{Unmap}

Terminates the SA Mapping state machine. The {Unmap} event is linked to a CM event not defined by this specification. The CM MAY implement the {Unmap} event.

{Map Reply}

CM has received an SA Map Reply message.

{Map Reject}

CM has received an SA Map Reject message.

{Timeout}

CM has timed out waiting for a response to an outstanding SA Map Request message.

{Max Retries}

CM has sent the maximum number of retries and not received a response.

Brief Description of Parameters

All configuration parameter values are obtained from the configuration file.

SA Map Wait Timeout

Timeout period between sending SA Map Request messages from SA Wait state (see Annex A).

SA Map Max Retries

This value specifies the maximum number of times that the CM may retry an SA Map Request.

Actions

Actions taken in association with state transitions are listed by <event/rcvd message> - <state> below:

[Start] + {Map} → [Map Wait]:

- Send SA Map Request
- Set Map Request retry timer to SA Map Wait Timeout
- Set Map Retry Count to 0

[Map Wait] + {Unmap} → [Start]:

- Clear Map Request retry timer
- Terminate SA Mapping state machine

[Mapped] + {Unmap} → [Start]:

- Terminate SA Mapping state machine

[Map Wait] + {Map Reply} → [Mapped]:

- Clear Map Request retry timer

[Map Wait] + {Map Reject} → [Start]:

- Clear Map Request retry timer
- Terminate SA Mapping state machine

[Map Wait] + {Timeout} → [Map Wait]:

- Send Map Request
- Set Map Request retry timer to SA Map Wait Timeout
- Increment Map Retry Count
- If Map Retry Count > SA Map Max Retries, generate Max Retries event

[Map Wait] + {Max Retries} → Start:

- Terminate SA Mapping state machine

Annex D BPI/BPI+ Interoperability (Normative)

The DOCSIS 3.0 Security specification includes enhanced Baseline Privacy Plus requirements like those defined in the DOCSIS 1.1/2.0 Baseline Privacy Plus specification [DOCSIS BPI+]. Baseline Privacy Plus is based on the original requirements of the DOCSIS 1.0 Baseline Privacy specification [SCTE 22-2]. The original architecture and design of Baseline Privacy has been maintained where possible.

The evolution to DOCSIS 3.0 Security was not intended to immediately obsolete DOCSIS 1.0, 1.1, or 2.0 systems. A DOCSIS system's transition to DOCSIS 3.0 Security compliance may be incremental. In the meantime and thereafter, DOCSIS 1.0 Baseline Privacy, DOCSIS 1.1, or DOCSIS 2.0 Baseline Privacy Plus and DOCSIS 3.0 Security units may coexist within a DOCSIS system.

D.1 DOCSIS BPI/BPI+ Interoperability Requirements

BPI/BPI+ interoperability requirements are summarized in the following table. A Baseline Privacy Plus system **MUST** be backward compatible with Baseline Privacy according to this table, with the exception for the CMTSs that do not support DOCSIS 1.0 CMs. There are four unit capabilities defined here from the Baseline Privacy specification and supported by these interoperability requirements.

1. Cable Modem Termination System:
 - a) CMTS BPI: Baseline Privacy with 56-bit DES, and will accept both a 768 and 1024-bit public key modulus.
 - b) CMTS BPI – 40-bit: Baseline Privacy with 40-bit DES, and will accept both a 768 and 1024-bit public key modulus. DES can only operate in 40-bit mode.
2. Cable Modem:
 - a) CM BPI: Baseline Privacy with 56-bit DES, and either a 768 or 1024-bit public key modulus.
 - b) CM BPI – 40-bit: Baseline Privacy with 40-bit DES, and either a 768 or 1024-bit public key modulus. DES can only operate in 40-bit mode.

As defined in this specification, Baseline Privacy Plus introduces two additional unit types.

- a) CMTS BPI+: Baseline Privacy Plus with 56-bit DES and 128-AES, and will accept both a 768 and 1024-bit public key modulus.
- b) CM BPI+: Baseline Privacy Plus with 56-bit DES and 128-AES, and a 1024-bit public key modulus.

The CMTS and the CM negotiate the BPI/BPI+ compatible mode using the Privacy Support Modem Capability TLV (type 5.6) in the REG-REQ and REG-RSP messages. The requirements for BPI/BPI+ interoperability are:

- a) A CMTS **MUST** accept public keys with a modulus of both 768 and 1024-bits from a CM during authorization.
- b) If a CM with Baseline Privacy Plus (CM BPI+) is provisioned with a DOCSIS 1.0 style configuration file, the CM sets the Privacy Support Modem Capability TLV (type 5.6) to either BPI Support (0) or BPI+ Support (1) depending on its capability in that situation [DOCSIS MULPIv3.1].
- c) When a CMTS with Baseline Privacy Plus (CMTS BPI+) and DOCSIS 1.0 CM support receives the Privacy Support Modem Capability TLV set to BPI Support (type 5.6, value 0) or no type 5.6 TLV in the REG-REQ message from the CM, the CMTS **MUST** fall back into a Baseline Privacy compatible mode of operation [SCTE 22-2] for communications with that CM.
- d) When a CMTS with Baseline Privacy Plus is operating in a system that supports both BPI and BPI+ CMs, the TFTP server includes the following two kinds of configuration files:
 - Configuration file with all of the BPI parameters (type 17.1 through 17.7) for the CMs provisioned to operate in BPI mode, and
 - Configuration file with all of or a part of the BPI+ parameters for the CMs provisioned to operate in BPI+ mode.

- e) When a CM with Baseline Privacy Plus (CM BPI+) receives the Privacy Support Modem Capability TLV set to BPI Support (type 5.6, value 0) or no type 5.6 TLV in the REG-RSP message from the CMTS, the CM MUST fall back into a Baseline Privacy mode of operation [SCTE 22-2] to communicate with the CMTS.

Table D-1 - BPI/BPI+ Interoperability Matrix

	CM BPI	CM BPI-40 bit	CM BPI+
CMTS BPI	Domestic BPI configuration. 768 or 1024-bit RSA modulus.	768 or 1024-bit RSA modulus. CMTS software zeroes TEK bits to 40-bit standard.	CM falls back into BPI mode with 1024-bit RSA modulus.
CMTS BPI-40 bit	768 or 1024-bit RSA modulus. CMTS software zeroes TEK bits to 40-bit standard.	768 or 1024-bit RSA modulus. All 40-bit compatibility handled by MAC chips.	CM falls back into BPI mode with 1024-bit RSA modulus. CMTS software zeroes TEK bits to 40-bit standard.
CMTS BPI+	CMTS falls back into BPI mode. 768 or 1024-bit RSA modulus.	768 or 1024-bit RSA modulus. CMTS software zeroes TEK bits to 40-bit standard.	Full BPI+ mode or BPI mode depending on configuration file and CMTS setting. 1024-bit RSA modulus.

D.2 BPI 40-bit DES Export Mode Considerations

The DOCSIS 3.0 Security specification is backward compatible with the 40-bit DES export mode of Baseline Privacy. The burden of compliance is placed on the CMTS. Not all DOCSIS equipment vendors will ever have the need to operate in a system with 40-bit DES capable BPI units. Therefore, compliance is up to the individual CMTS manufacturer. A CMTS SHOULD support backward compatibility to 40-bit DES Baseline Privacy. If it does, it MUST do so according to Section 11 of this specification.

1. When a CMTS is sending or receiving encrypted data between itself and a CM that uses 40-bit DES, the CMTS MUST zero the appropriate bits of its TEKs before encrypting or decrypting corresponding traffic data. The appropriate bits of the TEK MUST be zeroed according to the 40-bit TEK requirement of Baseline Privacy.
2. When encrypted traffic is to be passed between a CMTS with only 40-bit DES capability and a CM with a 56-bit DES capability, the CMTS MUST provide a 40-bit compliant TEK in the Key Reply Message to the CM.

The method a CMTS uses to recognize which CMs in a system are capable of 56-bit DES or only 40-bit DES, is left up to the individual system operator and CMTS vendor to accomplish in the manner that best fits their situation. One method for obtaining this information would be from the CM vendors, based on CM serial numbers, MAC address, manufacture dates, or some other device tracking mechanism. Once collected, the information would be incorporated into the CMTS database of information stored on each CM.

An alternative method for obtaining this information is with a DOCSIS BPI MIB defined for this purpose.

D.3 System Operation

D.3.1 CMTS with BPI Capability

A CMTS with BPI capability will always provision CMs using DOCSIS 1.0 style TFTP configuration files and BPI configuration settings. Both the BPI and BPI+ CMs will receive the BPI settings and each CM will only attempt to register as a DOCSIS 1.0 CM with BPI capability. If a CM returns a Modem Capability of BPI+ in the registration request, the CMTS will respond with this capability removed and force the CM to BPI compatibility.

D.3.2 CMTS with BPI+ Capability

A CMTS with BPI+ capability, which supports DOCSIS 1.0 CMs, MUST be capable of operating in both BPI and BPI+ compatible modes and to adjust according to the capability of each client CM it is capable of registering. When the CMTS has BPI+ capability and the system simultaneously supports BPI and BPI+ CMs, both DOCSIS 1.0 and DOCSIS 1.1, 2.0, or 3.0 configuration files are available to deliver the BPI+ and BPI configuration settings

to the appropriate CMs. A BPI capable CM will receive a DOCSIS 1.0 configuration file with BPI settings. If the CMTS provides support DOCSIS 1.0 CMs, the CM will then register with BPI Modem Capability.

Annex E Additions and Modifications for Chinese Specification (Normative)

This annex defines the Security requirements used in conjunction with the Chinese DOCSIS Architectures [C-DOCSIS].

This is an optional annex and in no way affects certification of equipment adhering to the North American technology option described in the sections referenced above.

The C-DOCSIS Cable Modem Termination System (CMTS) **MUST** support all the features and requirements as defined in this Security Specification. The C-DOCSIS Cable Modem (CM) **MUST** support all the features and requirements as defined in this Security Specification.

The following section identifies the main differences in security requirements as supported by devices deployed in C-DOCSIS architectures.

E.1 Security Requirement Differences for C-DOCSIS

- AES:
 - The CMTS **MAY** support Advanced Encryption Standard (AES) for traffic (packet PDU) encryption.

Appendix I Example Messages, Certificates, PDUs and Code File (Informative)

This appendix presents detailed examples that may be useful to implementers of the specification. The examples describe a typical key exchange: Authorization Info, Authorization Request, Authorization Reply, Key Request, and Key Reply. Details of the cryptographic calculations are provided at each step, and example certificates are included. The examples also include several Packet PDUs, encrypted using the keying material derived in the example key exchange.

This appendix is informative only. In the event of any discrepancy between this appendix and the main body of the specification or its associated annexes exists, the latter will take precedence.

I.1 Notation

In the examples here, packets are represented as a stream of octets, each octet in hexadecimal notation, sometimes with a text annotation. The order of transmission for the octets is left to right, top to bottom. For example, consider the following representation of a packet:

00 01 02 03	Description #1
04 05	
06 07 08	Description #2

The packet consists of 9 octets, represented in hexadecimal notation as "00", "01", ..., "08." The octet represented by "00" is transmitted first, and the octet represented by "08" is transmitted last.

In the discussion of the examples, integer values are represented in either hexadecimal notation using an "0x" prefix or in decimal notation with no prefix. For example, the hexadecimal notation 0x12345 and the decimal notation 74565 represent the same integer value. All integer values are non-negative. Thus, 0xff represents the integer having value 255, not a negative value.

The BPKM protocol requires that devices generate and distribute DES keys without regard to parity. Devices ignore the value of the least significant bit of each octet. In the examples here, keys are represented without parity correction.

I.2 Authentication Info

The CM sends the following Authentication Info message:

0C 01 05 4F	Auth Info header (code=12, id=1, len=54f)
11 05 4C	CA Certificate header (type=17, len=0x54C)
30 82 05 B4 30 82 03 9C . . . 9D D1 DD 05 4B 03 AB 51	CA Certificate

The code field has value 0x0c, which identifies this as an Authentication Info message. The Length field has a value of 0x54F (1359), which is the number of octets that follow the Length field.

The only attribute is the CA Certificate. Details of the certificate are given below.

I.2.1 Device CA Certificate Details

The fields of the Device CA Certificate in the Authorization Info message are as follows:

30 82 05 48	Certificate header
30 82 03 30	TbsCertificate

	header
a0 03 02 01 02	Version, 0x2=v3
02 08 02 02 02 02 02 02 02	serial number, 0202020202020202
30 0D 06 09 2A 86 48 86 F7 0D 01 01 0B 05 00	Signature type sha256, null optional parameters
30 6E 31 0B	issuer header
30 09 06 03 55 04 06 13 02 55 53	countryName, US
31 12 30 10 06 03 55 04 0A 13 09 43 61 62 6C 65 4C 61 62 73	organizationName, CableLabs
31 12 30 10 06 03 55 04 0B 13 09 52 6F 6F 74 20 43 41 30 31	organizationalUnitN ame, Root CA01
31 37 30 35 06 03 55 04 03 13 2E 45 78 61 6D 70 6C 65 20 43 61 62 6C 65 4C 61 62 73 20 52 6F 6F 74 20 43 65 72 74 69 66 69 63 61 74 69 6F 6E 20 41 75 74 68 6F 72 69 74 79	commonName, Example CableLabs Root Certification Authority
30 1e	Validity header
17 0D 31 34 30 39 31 37 32 30 30 38 32 38 5A	notBefore, UTCTime 14/09/17 20:08:28Z
17 0D 34 39 30 39 31 37 32 30 30 38 32 38 5A	notAfter, UTCTime 49/09/17 20:08:28Z
30 72 31 0B	Subject header
30 09 06 03 55 04 06 13 02 55 53	countryName, US
31 12 30 10 06 03 55 04 0A 13 09 43 61 62 6C 65 4C 61 62 73	organizationName, CableLabs
31 14 30 12 06 03 55 04 0B 13 0B 44 65 76 69 63 65 20 43 41 30 31	organizationalUnitN ame, Device CA01
31 39 30 37 06 03 55 04 03 13 30 45 78 61 6D 70 6C 65 20 43 61 62 6C 65 4C 61 62 73 20 44 65 76 69 63 65 20 43 65 72 74 69 66 69 63 61 74 69 6F 6E 20 41 75 74 68 6F 72 69 74 79	commonName, Example CableLabs Device Certification Authority
30 82 01 A2	subject public key info header
30 0D 06 09 2A 86 48 86 F7 0D 01 01 01 05 00	public key algorithm type, RSA, null optional parameters
03 82 01 8F 00 30 82 01 8A 02 82 01 81	public key header
00 B6 A4 74 E7 A0 D4 BD 37 BB 5A E5 66 5A B8 5E 71 0B F8 71 5D 3F 9F 27 91 B0 41 6B FF 23 83 1A DB 16 48 12 9D 17 56 15 CE 7E DA 47 79 B8 0A 03 8A F7 50 A3 74 BE 83 68 19 AA A5 CE 0B 6C CA 17 6A FF 12 8A 8B EA E4 82 C7 5F 10 20 49 67 96 22 B1 2C 17 0E 93 02 99 B5 7A 29 44 4B D5 ED 9D F2 DA B1 16 A8 D3 99 C6 EE F5 7E 06 59 AF 15 D3 3D 8A 5D C5 08 25 17 7E 9C 53 E1 04 DF 93 C8 F5 37 1A BE C8 0C 8D EE BF 3A C6 D7 D3 B1 18 2F DC FB 20 F2 D6 CA 53 A5 EE 66 F0 54 B1 02 15 68 78 78 26 C6 F7 CC B5 DF 89 9D A6 B8 93 E1 5D 7C FB FB 1A FD 52 2E E8 18 EE FF 07 8B B1 2E 51 C8 BC 72 ED 22 E9 32 4B 77 AC E8 7D A8 C5 79 81 91 9B 80 65 10	public key modulus (3072 bit)

AC 41 46 42 1B F3 16 63 6A 82 EE A6 02 73 BA CB AA 50 20 A3 77 09 E4 B6 68 81 01 B3 5F B5 C4 B4 6E F0 B4 20 16 11 29 36 25 FA 35 B6 AD 4C 17 4F 8D EF CA 80 17 AA 21 77 6D DC 17 27 67 5B 6A 76 A6 C7 81 E7 73 BE E7 D8 A2 C7 B3 75 75 DE 5C 61 6F 69 C0 DC 6C 18 D1 F4 E8 77 20 4C 31 8F 21 CB 22 36 D3 F9 F8 47 20 D6 AD 5B E6 ED D8 EE CF 68 0E 18 BF C4 DF 12 E7 30 AB C7 3C 64 F8 77 FE 6D 74 E6 87 25 05 11 4A 35 E9 63 58 33 83 30 99 3A 1D 67 42 20 93 C2 DD 74 9C ED 9C E8 5D 47 9D 80 09 C5 E2 BC 6B 79 4E CE 17 F1 FE 55 0A 92 5B	
02 03 01 00 01	public key exponent header and value
A3 66 30 64	X.509 extensions header
30 0E 06 03 55 1D 0F 01 01 FF 04 04 03 02 01 06	Key usage, critical=true, CertSign, CRLSign
30 12 06 03 55 1D 13 01 01 FF 04 08 30 06 01 01 FF 02 01 00	Basic Constraints, critical=true, CA=true, pathlen:0
30 1D 06 03 55 1D 0E 04 16 04 14 42 A8 6E 6F 36 31 17 1B 17 EF 94 99 96 81 90 C9 B8 07 49 77	Subject key id
30 1F 06 03 55 1D 23 04 18 30 16 80 14 1F 43 E6 00 FC 16 2E 5A EA A5 4E 78 6F 04 64 E1 AE E6 A4 A8	Authority key id
30 0D 06 09 2A 86 48 86 F7 0D 01 01 0B 05 00	signature algorithm, sha256 with RSA encryption, null optional parameters
03 82 02 01	Signature header
00 6F 20 2F D3 C5 1F C2 41 5A 3E 85 89 E0 0B D8 EC 3B D7 B1 63 C3 4A 62 81 E4 BA 65 AE 76 43 62 A6 32 0D 72 1A 0A 5B 22 A4 F7 82 37 39 33 7E 99 DC CC D5 78 D9 C4 B5 A9 A3 E8 D9 38 83 17 C5 3B 14 CC DF 2B E1 E8 6C 62 8F A3 19 CB 23 CB B4 4A 7E A2 2E F3 98 00 71 17 C8 C2 B1 DE 12 9E B4 10 F2 40 85 B3 BB E6 0A 8D 93 41 B4 BE 51 94 45 3B BA 4B 7F C6 DF D8 94 C5 9F 82 B8 AC 6D 70 B9 65 66 59 7A F2 C1 CA CB 7A AF AA D4 7C 00 00 BB F5 EC 48 D6 E0 F0 FA 64 FC B6 4C 72 BB 40 56 96 E0 29 8F 98 2A FE E4 98 88 F9 D5 56 81 33 19 4E 13 43 A2 37 16 B0 EA 5B AC A4 9C 71 D8 7F DC FC 8A 46 16 62 9B 4D D1 77 F0 0B 7B AF 37 89 34 67 1C 65 DE DB 42 EF 26 36 55 13 17 A4 7D 1B BE 45 06 B4 ED 62 C8 DC 08 12 33 4D 71 99 06 98 6D FD DB 90 01 50 E8 CD A7 34 1B EB 19 82 D7 49 1F D1 31 44 C0 E3 B4 8B D3 32 95 92 4E 80 65 67 54 4D ED 61 1C 4C C0 29 92 03 9B 2E B3 F8 E6 86 63 EA F5 69 24 B4 BD 3F 59 E7 9C 82 B6 89 AE 84 F4 51 65 2D D6 68 49 58 44 DA 64 BD 77 FA A4 7E 22 4E B0 3E 2E 2E 8B F1 E5 1E B9 1E 3B 70 E6 E6 43 09 04 DA 39 B2 C1 5F 12 74 18 46 CC 66 5B 03 1F 71 7B C3 19 22 87 5C 4C DA 0A D3 59 05 68 63 0E 0A 7A 13 2E A2 07 FB B8 8A 45 8F 5F 55 FC DD 11 CC D8 62 A0 55 7F 1F AD 83 8D 81 98 F2 6E E3 64 DE 52 37 80 41 0E 62 C9 AD D9 76 02 20 B8 A1 93 79 A4 41 4C B6 14 A5 0C B9 04 AA A3 BB 13 24 B7 35 C7 D6 F8 47 5B F1 7C 2B CE A5 1E 8C F6 E0 E5 9C 17 90 D2 A5 60 D7 98 47 8C 1B 90 63 2F C3 9A FA 16 A1 2A BA 78 0F 69 E1 7C 28 3F 41 4A E5 70 37 0A 7B 1D C5 C6 5B 09 5B 90 3D 63 75 A7 90 2C 5D 6B EA 68 B5 9F B0 CB 0A 6B B7 19 1B D3 C5 1A D8 E2 43	Signature value

Some of the fields in this example are identical in all CA certificates. These fields are:

- Version: v3
- Signature : SHA-256 with RSA, NULL parameters
- Public key algorithm type: RSA encryption, NULL parameters
- Public key exponent: 3-octet integer, value 0x10001
- Signature algorithm: SHA-256 with RSA, NULL optional encryption parameters

This is an example of a CableLabs Device CA certificate. While the countryName and organizationName are identical for both issuer and subject, the organizationalUnitName differs between issuer and subject.

Other fields that are example values include:

- The serial number: INTEGER of 8 octets, value 0x0202020202020202 (other CA certificates may use a different length)
- Not before: 2014/09/17 20:08:28 UTC
- Not after: 2049/09/17 20:08:28 UTC
- Public key modulus: INTEGER of 3072 bits, value 0x00B6A474... 550A925B with exponent of 0x10001
- X.509 v3 certificate extensions that include keyUsage, basicConstraints, subjectKeyIdentifier, and authorityKeyIdentifier
- Signature value: A BIT STRING representing the INTEGER value 0x6F202FD3... 1AD8E243. The signature is computed over the portion of the certificate that begins with the tbsCertificate header and ends with the public key exponent.)

I.3 Authorization Request

The CM sends the following Authorization Request:

04 01 05 44	Auth Request header Code=4, Id=1, len=0x544
05 01 30	CM-Identification header, type=5
01 00 0e 39 33 33 38 33 57 56 47 2d 31 32 2d 35 34	Serial Number, type=1, len=e, v=93383WVG-12-54
02 00 03 00 10 18	Manufacturer ID, type=2, v=001018
03 00 06 00 10 18 de 02 3e	MAC Address
04 01 0F 30 82 01 0A 02 82 01 01	RSA Public Key Header
00 C1 32 23 2A 3B 2B 3F B1 0C A6 27 92 47 9C EE 19 B3 77 82 8D 04 DA 17 A1 A0 C5 5B 6F 4F 5E FE 11 1F CC 91 10 EB F9 12 C2 B1 6B 38 50 3B 23 BE E0 25 75 95 F0 77 1F 91 B0 18 15 DB 17 11 D3 A0 BA 91 EF 7E 00 9C 05 DE 0A 91 5F 3B 8F 6E 6D 57 6F 1D 3B 26 50 94 F5 E1 C3 59 F9 66 1C FB 79 6D C5 23 F9 9B 73 F7 B2 E0 D5 78 08 7D 25 FF 67 F9 AA 53 DD 26 4A 8D 1F 3B 9E AA 6C BB 70 E2 2A 51 78 62 B2 BB DB F7 B7 9A 34 67 F2 26 A2 AC BA 3E 00 E7 21 73 66 5B 7E BD 6A EF B1 A9 38 15 36 03 53 73 3A B4 30 94 8D 89 9A A1 0D 77 32 42 47 A1 CE 61 C4 2E 20 91 AE E4 43 5D BF 91 E3 91 3B 43 DF 6F 47 99 43 8B CF 10 C3 D7 D4 D6 3A E9 30 B7 87 70 14 FE 4D 5C A1 EF 1C F5 7F 9C E7 3E C5 A5 0F 45 B4 D6 56 FD 2D	RSA Public Key modulus and exponent

4D BD F2 E5 7B ED 0B C8 A8 5E 42 F9 11 09 13 A8 CC D0 C4 57 A9 DF 54 3B A0 85 02 03 01 00 01	
12 03 fc	CM Certificate header
30 82 03 f8 30 82 02 60 . . . A8 B5 A7 D0 BB 3F 43 97	CM Certificate (see below for details)
13 00 0B	Security Capabilities header
15 00 04 01 00 03 00	Cryptographic Suite List
16 00 01 01	BPI Version
0c 00 02 00 00	SAID

The Code field has a value of 0x04, which identifies this as an Authorization Request packet. The Identifier field has value 0x01; this is an example value. The Length field has value 0x0544 (1348), which is the number of octets that follow the Length field.

The first attribute is the CM-Identification, which is a compound attribute consisting of the following sub-attributes: Serial Number, Manufacturer ID, MAC Address, and RSA Public Key. Example values are shown for these sub-attributes.

The Public Key is DER encoded and is similar to the example in [RSA2]. The modulus is a 2048-bit integer encoded in 0x101 (257) octets. In this example, the value of the encoded modulus is:

0x00C13223 ... 543BA085

0x00 is the most significant octet of the encoded modulus and 0x85 is the least significant. The exponent is a 3-octet integer with the value 0x010001.

The next attribute is the CM Certificate. Details of the certificate are given below.

NOTE: The MAC Address and RSA Public Key of the CM Identification match fields in the CM Certificate.

The next attribute is the Security Capabilities attribute, which is a compound attribute consisting of the Cryptographic Suite List and the BPI Version. In this example, the Cryptographic Suites listed is 56-bit DES with no authentication. The BPI Version is BPI+.

The final attribute is the CM's Primary SAID, whose value is equal to its Primary SID. In this example, the Primary SAID has value 0x0000.

I.3.1 CM Device Certificate Details

The fields of the CM Device Certificate in the Authorization Request message are as follows:

30 82 03 F8	certificate header
30 82 02 60	tbsCertificate header
a0 03 02 01 02	Version, v3=0x2
02 08 03 03 03 03 03 03 03	serial number, 0303030303030303
30 0D 06 09 2A 86 48 86 F7 0D 01 01 0B 05 00	Signature type, sha256 with RSA encryption, optional parameters null

30 72	issuer header
31 0B 30 09 06 03 55 04 06 13 02 55 53	countryName, US
31 12 30 10 06 03 55 04 0A 13 09 43 61 62 6C 65 4C 61 62 73	organizationName, CableLabs
31 14 30 12 06 03 55 04 0B 13 0B 44 65 76 69 63 65 20 43 41 30 31	organizationalUnitName, Device CA01
31 39 30 37 06 03 55 04 03 13 30 45 78 61 6D 70 6C 65 20 43 61 62 6C 65 4C 61 62 73 20 44 65 76 69 63 65 20 43 65 72 74 69 66 69 63 61 74 69 6F 6E 20 41 75 74 68 6F 72 69 74 79	commonName, Example CableLabs Device Certification Authority
30 1E	validity header
17 0D 31 34 30 39 31 37 32 30 31 39 35 37 5A	notBefore, 14/09/17 20:19:57Z
17 0D 33 34 30 39 31 37 32 30 31 39 35 37 5A	notAfter, 34/09/17 20:19:57Z
30 51	subject header
31 0B 30 09 06 03 55 04 06 13 02 55 53	countryName, US
31 11 30 0F 06 03 55 04 0A 13 08 42 72 6F 61 64 63 6F 6D	organizationName, Broadcom
31 13 30 11 06 03 55 04 0B 13 0A 44 75 6C 75 74 68 2C 20 47 41	organizational unit name, Duluth, GA
31 1A 30 18 06 03 55 04 03 13 11 30 30 3A 31 30 3A 31 38 3A 30 31 3A 30 32 3A 30 33	commonName (MAC address), 00:10:18:01:02:03
30 82 01 22	subject public key info header
30 0D 06 09 2A 86 48 86 F7 0D 01 01 01 05 00	public key algorithm type, RSA, null optional parameters
03 82 01 0F 00 30 82 01 0A 02 82 01 01	public key header
00 C1 32 23 2A 3B 2B 3F B1 0C A6 27 92 47 9C EE 19 B3 77 82 8D 04 DA 17 A1 A0 C5 5B 6F 4F 5E FE 11 1F CC 91 10 EB F9 12 C2 B1 6B 38 50 3B 23 BE E0 25 75 95 F0 77 1F 91 B0 18 15 DB 17 11 D3 A0 BA 91 EF 7E 00 9C 05 DE 0A 91 5F 3B 8F 6E 6D 57 6F 1D 3B 26 50 94 F5 E1 C3 59 F9 66 1C FB 79 6D C5 23 F9 9B 73 F7 B2 E0 D5 78 08 7D 25 FF 67 F9 AA 53 DD 26 4A 8D 1F 3B 9E AA 6C BB 70 E2 2A 51 78 62 B2 BB DB F7 B7 9A 34 67 F2 26 A2 AC BA 3E 00 E7 21 73 66 5B 7E BD 6A EF B1 A9 38 15 36 03 53 73 3A B4 30 94 8D 89 9A A1 0D 77 32 42 47 A1 CE 61 C4 2E 20 91 AE E4 43 5D BF 91 E3 91 3B 43 DF 6F 47 99 43 8B CF 10 C3 D7 D4 D6 3A E9 30 B7 87 70 14 FE 4D 5C A1 EF 1C F5 7F 9C E7 3E C5 A5 0F 45 B4 D6 56 FD 2D 4D BD F2 E5 7B ED 0B C8 A8 5E 42 F9 11 09 13 A8 CC D0 C4 57 A9 DF 54 3B A0 85	public key modulus
02 03 01 00 01	public key exponent

A3 33 30 31	X.509 extension header
30 0E 06 03 55 1D 0F 01 01 FF 04 04 03 02 05 A0	keyUsage, critical, DigitalSignature, key encipherment
30 1F 06 03 55 1D 23 04 18 30 16 80 14 42 A8 6E 6F 36 31 17 1B 17 EF 94 99 96 81 90 C9 B8 07 49 77	authorityKeyIdentifier, keyId
30 0D 06 09 2A 86 48 86 F7 0D 01 01 0B 05 00	signature algorithm, sha256 with RSA encryption, null optional parameters
03 82 01 81	signature header
00 43 E6 0C D1 80 A5 C5 FA D9 72 64 66 CA ED 21 B2 AF C6 83 9E B2 D8 79 1F 6C B3 02 1E C5 28 E1 33 68 E5 DC C0 D5 CF 98 1A FB 55 ED 88 29 67 BB B5 38 21 11 4A CE 68 30 75 F7 99 88 EB 99 C9 30 31 34 9D 06 0D DC BB 63 62 E5 C4 F6 BC AD 4D EA 28 4E C9 26 9B F8 1B F5 B5 63 F0 68 7E 82 2C D6 75 17 E6 EB 8E E8 1F 5A 1A A1 82 59 B5 04 A0 11 83 C0 C2 67 63 DF 68 49 C6 E7 DC A6 C0 EF 67 3E B9 6D FB B8 F8 E7 C4 3D FB 21 F7 17 F0 01 A0 B0 DE D5 D3 FF CD 2E 38 3C F4 7D 9D C2 B5 B5 50 7A 52 A9 6F 93 F8 3B 14 E1 28 AC 74 29 18 F4 81 1E A9 08 0A D8 9A 87 7D DB FD F6 E6 4E 06 05 33 95 28 61 A0 E1 AB 19 C4 96 C6 80 0C 15 DC C5 96 4B A2 0D 52 1D FD 78 0F D3 01 E7 D6 82 10 39 9C A8 A7 BA 48 EE 7C 46 64 85 79 1D 8E E2 01 21 37 9E BA AD 58 65 77 CE 6F E6 2D D6 19 AF 3F DB C1 0A 06 79 F3 42 A3 05 7B A2 6F 58 48 7D DD 1F B4 0B 79 15 2D 47 D8 CD 6F B9 D2 AA BF BB B8 A6 2F A5 31 F8 D1 04 10 45 50 F1 F1 45 75 F7 1D 4F 6C 7B 0A 5A 37 58 CF 7C 68 71 7E 3C 27 46 B7 A4 A5 AD E4 38 D2 3A 4D 54 08 3F 07 68 FE A4 35 12 87 39 C9 F0 5E 77 41 03 1A 2A 7A BD 61 B7 68 1B F6 BD 64 C1 E9 52 15 8F 8B 70 0A 34 FF 90 57 E1 FA 3A 83 4C 7A CC 0D E6 C5 AF 8D A8 B5 A7 D0 BB 3F 43 97	signature value

Some of the fields in this example are identical for all CM Certificates. These fields are:

- Version: v3
- Signature: SHA-256 with RSA, NULL parameters
- issuer first organizational unit name: Device CA01
- Public key algorithm type: RSA encryption, NULL optional encryption parameters
- Public key exponent: 3-octet integer, value 0x10001
- Signature algorithm: SHA-256 with RSA, NULL optional parameters

The issuer name of the CM certificate matches the subject name of the Device CA certificate. In this example, the matching issuer-name fields are:

- Country name: "US"
- Organization name: "CableLabs"
- First organizational unit name: "Device CA01"
- Common name: "Example CableLabs Device Certification Authority"

The other fields are example values. Some of these are:

- serial number: integer of 8 octets, value 0x0303030303030303 (other CM certificates may use a different length)
- Not before: 17/09/2014 20:19:57 UTC
- Not after: 17/09/2034 20:19:57 UTC
- Subject country name: "US"
- Subject organization name: "Broadcom"
- Subject organizational unit name: "Duluth, GA"
- Subject common name (MAC address): "00:10:18:01:02:03" (All CM certificates use a string of this length. The value matches the MAC Address attribute of the Authorization Request message.)
- Public key modulus: integer of length 2048 bits, encoded as 0x00C13223... 543BA085
- Signature value: BIT STRING representing the integer value 0x43E60CD1... BB3F4397 . The signature is computed over the portion of the certificate that begins with the tbsCertificate header and ends with the public key exponent, inclusive.

I.4 Authorization Reply

The CMTS sends the following Authorization Reply:

05 01 01 1F	Auth Reply header
07 01 00 28 27 55 DB F5 22 67 82 52 12 07 31 D2 B4 4D 35 8F 5F F6 51 54 7E A3 5C DD B9 11 B9 7F 92 1E B7 7E 47 77 B1 4A FE D2 AB 83 AD AE 29 8A 22 06 0A 76 F4 D7 C3 CB 80 45 1F 99 44 7E B9 50 90 F9 BD D4 B5 2E 25 D1 E6 4C A7 E9 45 0D B1 E9 63 45 38 F6 D9 83 79 82 3C 7B 93 80 8F DD 3D 0B 32 E3 4C 97 7D 8B 82 F0 16 17 FB F1 67 2E EE 39 57 39 B1 20 EB 13 B0 E1 D2 90 02 03 2C CA F9 3C A3 C1 6A CE 9A 5D BE ED F2 6E 86 2F 57 63 3B FE 13 DB D1 FE F0 1F 3E 9B D1 45 23 F6 F3 47 6F 87 61 01 01 57 C7 CE F3 D9 A1 14 05 DC 39 FA B8 BE E6 25 21 F4 FE BE 32 3D 6C 96 87 DE 17 AF F1 0A 83 35 19 93 C8 3D 89 BE 17 7B 36 CA 69 17 10 9B E1 19 24 F4 22 54 6E F3 04 38 1E B9 3C 5A 3B E0 6F 05 55 E4 85 C5 F9 81 13 9D E7 A9 8C 42 07 69 12 F8 2B 80 2D 6F 65 E9 4F 93 09 B3 C1 1E DD 89 68 95 20	Auth Key
09 00 04 00 09 3A 80	Key Lifetime
0A 00 01 07	Key Sequence number
17 00 0E	SA Descriptor header
0C 00 02 22 60	SAID
18 00 01 00	SA Type
14 00 02 01 00	Cryptographic Suite

The Code field has value 0x05, which identifies this as an Authorization Reply packet. The Identifier field has value 0x01, matching the Identifier field of the Authorization Request. The Length field has value 0x011F (287), which is the number of octets that follow the Length field.

The first attribute is the encrypted Authorization Key (attribute type 7). The attribute contains an authorization key which has been RSA-encrypted using the public key received by the CMTS from the CM in the Authorization

Request message. The RSA-encrypted authorization key is an integer made up of 0x100 (256) octets. In this example, the value of the RSA-encrypted authorization key is 0xa2827 . . . 9520.

0x28 is the most significant octet of the RSA-encrypted authorization key and 0x20 is the least significant octet.

The second attribute is the Key Lifetime. In this example, the value is 0x00093a80 (604800) seconds, which is equivalent to 7 days.

The third attribute is the Key Sequence Number. In this example, the value is 0x07.

The remaining attributes are SA Descriptors. Each SA Descriptor is a compound attribute consisting of the following sub-attributes: SAID, SA Type, and Cryptographic Suite. In this example, a single SA Descriptor is included, corresponding to the SAID in the Authorization Request. The SA Type is Primary, and the Cryptographic Suite is 56-bit DES with no authentication.

I.4.1 Derivation of the Encryption Keys

The CM and CMTS each derive a key encryption key and two message authentication keys from the authorization key, using hashing. Details of the hashing calculations are given below. Here are the values of these keys for this example:

Authorization key	4e 85 27 ff c4 12 72 8e 61 84 de c9 20 b6 e0 64 f0 bc 0b 75
Key encryption key	76 b4 d4 2f 14 98 59 6a ab fe 72 94 15 7c 7d 62
Message authentication key, upstream	fe b9 f1 e2 46 a7 6d 7c a7 7b 5e b0 98 25 fd 0b 57 ca 90 c7
Message authentication key, downstream	93 d3 9d 70 c3 b6 f5 92 c4 6b d3 92 76 46 f4 f1 90 3a 52 fd

I.4.2 Encryption of the Authorization Key

The CMTS generates an authorization key of 20 octets. In this example, the value of the authorization key is:

4e 85 27 ff c4 12 72 8e 61 84 de c9 20 b6 e0 64 f0 bc 0b 75

The authorization key is encrypted using the RSAES-OAEP scheme in [RSA3]. The scheme makes use of a mask-generating function (MGF1), based on hashing using the SHA-1 hash as well as the OAEP padding scheme. The CMTS encrypts the authorization key using the public key received by the CMTS from the CM in the Authorization Request message. In this example, the encrypted value is as show below.

28 27 55 DB F5 22 67 82 52 12 07 31 D2 B4 4D 35 8F 5F F6 51 54 7E A3 5C DD B9 11 B9 7F 92 1E B7 7E 47
 77 B1 4A FE D2 AB 83 AD AE 29 8A 22 06 0A 76 F4 D7 C3 CB 80 45 1F 99 44 7E B9 50 90 F9 BD D4 B5 2E
 25 D1 E6 4C A7 E9 45 0D B1 E9 63 45 38 F6 D9 83 79 82 3C 7B 93 80 8F DD 3D 0B 32 E3 4C 97 7D 8B 82 F0
 16 17 FB F1 67 2E EE 39 57 39 B1 20 EB 13 B0 E1 D2 90 02 03 2C CA F9 3C A3 C1 6A CE 9A 5D BE ED F2
 6E 86 2F 57 63 3B FE 13 DB D1 FE F0 1F 3E 9B D1 45 23 F6 F3 47 6F 87 61 01 01 57 C7 CE F3 D9 A1 14 05
 DC 39 FA B8 BE E6 25 21 F4 FE BE 32 3D 6C 96 87 DE 17 AF F1 0A 83 35 19 93 C8 3D 89 BE 17 7B 36 CA
 69 17 10 9B E1 19 24 F4 22 54 6E F3 04 38 1E B9 3C 5A 3B E0 6F 05 55 E4 85 C5 F9 81 13 9D E7 A9 8C 42 07
 69 12 F8 2B 80 2D 6F 65 E9 4F 93 09 B3 C1 1E DD 89 68 95 20

Note the size of the encrypted authorization key is identical to the size of the modulus of the public key.

The CM decrypts the authorization key sent from the CMTS using its private key.

I.4.3 Hashing Details

The authorization key is hashed using the SHA-1 algorithm [FIPS 180-4] to produce the Key Encryption Key (KEK), the message authentication key for upstream, and the message authentication key for downstream.

The discussion here represents a hash calculation with a table that shows the input to the hash function and the resulting hash value. For reference, displayed below, is such a table that describes the example in [FIPS 180-4]:

Hash input	61 62 63 64 62 63 64 65 63 64 65 66 64 65 66 67 65 66 67 68 66 67 68 69 67 68 69 6a 68 69 6a 6b 69 6a 6b 6c 6a 6b 6c 6d 6b 6c 6d 6e 6c 6d 6e 6f 6d 6e 6f 70 6e 6f 70 71
Hash value	84 98 3e 44 1c 3b d2 6e ba ae 4a a1 f9 51 29 e5 e5 46 70 f1

1.4.3.1 KEK

The KEK is computed using the following hash calculation:

Hash input	53 4e 85 27 ff c4 12 72 8e 61 84 de c9 20 b6 e0 64 f0 bc 0b 75
Hash value	76 b4 d4 2f 14 98 59 6a ab fe 72 94 15 7c 7d 62 b0 df e6 3b

The input is the octet 0x53, repeated 63 times, followed by the 20 octets of the authorization key. The order in which the octets of the authorization key are digested is the same as the order in which they appear in the EM encryption block.

The hash value is 20 bytes long. The first 16 bytes are the KEK.

1.4.3.2 Message Authentication Keys

The upstream message authentication key is computed using the following hash calculation:

Hash input	5c 4e 85 27 ff c4 12 72 8e 61 84 de c9 20 b6 e0 64 f0 bc 0b 75
Hash value	fe b9 f1 e2 46 a7 6d 7c a7 7b 5e b0 98 25 fd 0b 57 ca 90 c7

The input is the octet 0x5c, repeated 63 times, followed by the 20 octets of the authorization key. The order in which the octets of the authorization key are digested is the same as in the KEK calculation.

The hash value is 20 octets long. The 20 octets make up the upstream message authentication key.

The downstream message authentication key is computed using the following hash calculation:

Hash input	3a 4e 85 27 ff c4 12 72 8e 61 84 de c9 20 b6 e0 64 f0 bc 0b 75
Hash value	93 d3 9d 70 c3 b6 f5 92 c4 6b d3 92 76 46 f4 f1 90 3a 52 fd

This is similar to the computation for the upstream case, except that value 0x3a replaces value 0x5c.

1.4.3.3 Mask- Generation Function

The mask-generation function (MGF) is constructed from SHA-1 hash operations. Each hash operation generates 20 octets of mask data. The number of hash operations performed depends on the size of the mask that is needed.

Quantity SEED_MASK is formed by applying the MGF to MASKED_DB. Since SEED_MASK is 20 octets long, this requires only one hash operation:

Hash input	04 29 6a b7 1f a2 a1 7f 96 60 d7 96 47 33 9d 2d bc a3 a1 32 37 ac 86 06 7c b5 ec 97 d2 d0 9e 01 30 2b 10 91 3a ec 3f d9 a1 2f c4 e9 8d 18 88 95 f6 9c ea 17 23 9f 5d d5 f1 4d 25 8e 9e 6d 7d 3c ca 55 fe 0e ee 2d 0d 7e 5b 64 b6 79 44 76 cc 3f 6e ac 99 3a ae 14 3f d4 0b f8 c3 f2 6b 2a 3c 9b 97 ac 91 6c 7c e4 c5 5f 7b cf 17 00 00 00 00
Hash value	b4 b6 f1 bf a6 b3 a1 7e 95 82 d3 b8 93 71 b6 7f 45 31 9e 82

The input data to the hash operation are the 107 octets MASKED_DB followed by four octets of value 0. The output of the hash operation is the value of SEED_MASK.

Quantity DB_MASK is formed by applying the MGF to SEED. Since DB_MASK is 107 octets long, this requires six hash operations:

Hash input	ad 9c af 8d f8 26 fe af b5 df fd 95 de 7e 97 cc e9 4b 6d 6d 00 00 00 00
Hash value	de 10 c9 59 41 c9 ea 72 a4 35 68 79 d2 53 85 bd 13 7b a6 3b
Hash input	ad 9c af 8d f8 26 fe af b5 df fd 95 de 7e 97 cc e9 4b 6d 6d 00 00 00 01
Hash value	37 ac 86 06 7c b5 ec 97 d2 d0 9e 01 30 2b 10 91 3a ec 3f d9

Hash input	ad 9c af 8d f8 26 fe af b5 df fd 95 de 7e 97 cc e9 4b 6d 6d 00 00 00 02
Hash value	a1 2f c4 e9 8d 18 88 95 f6 9c ea 17 23 9f 5d d5 f1 4d 25 8e

Hash input	ad 9c af 8d f8 26 fe af b5 df fd 95 de 7e 97 cc e9 4b 6d 6d 00 00 00 03
Hash value	9e 6d 7d 3c ca 55 fe 0e ee 2d 0d 7e 5b 64 b6 79 44 76 cc 3f

Hash input	ad 9c af 8d f8 26 fe af b5 df fd 95 de 7e 97 cc e9 4b 6d 6d 00 00 00 04
Hash value	6e ac 99 3a ae 14 3e 9a 8e df 3c 36 79 58 b2 fa 13 72 58 4c

Hash input	ad 9c af 8d f8 26 fe af b5 df fd 95 de 7e 97 cc e9 4b 6d 6d 00 00 00 05
Hash value	ca 04 a1 af c7 c4 62 3a df 6f 33 ec e2 cd 2c 7f b7 7e 48 19

The input data to each hash operation are the 20 octets of SEED followed by a four-octet value. The four-octet value counts the integer values 0, 1, 2, 3, 4, 5 on successive hash operations. The outputs of the six hash operations are concatenated into a 120-octet result, and the first 107 octets of the result constitute DB_MASK.

I.5 Key Request

The CM sends the following Key Request:

07 73 00 d0	Key Request Header
05 00 ad	CM-Identification header
01 00 0c 30 30 30 30 30 30 31 32 33 34 35 36	Serial Number
02 00 03 25 53 41	Manufacturer ID
03 00 06 00 00 ca 01 04 01	MAC Address
04 00 8c 30 81 89 02 81 81 00 e0 e0 6c 8d be b2 8b c9 f3 a6 3d a1 12 ea f7 99 f7 3d 3e fa a3 b1 e2 42 95 71 b5 71 d2 32 7a da 10 40 e2 5b 09 74 69 08 78 46 37 71	RSA public key

34 3e 69 a7 37 6d f8 70 1d aa a5 34 b0 33 a3 43 ac 4d eb 41 5e 0a 8a fd a6 0a 4b 09 7f 5a 18 f2 9e c2 22 a6 6b 9a 69 73 22 d5 37 c9 63 b0 88 f5 60 5d 99 16 33 54 53 30 ed 35 de 0c 87 3b 54 ba 59 22 3e b2 79 90 96 61 db f3 4a 37 18 4c 7f a8 ca ee d6 31 02 03 01 00 01	
0a 00 01 07	Key Sequence Number
0c 00 02 22 60	SAID
0b 00 14 86 b8 33 b7 48 9c 4b a1 51 67 44 d7 a6 e6 ca 21 33 f5 22 9e	HMAC digest

The code field has value 0x07, which identifies this as a Key Request packet. The identifier field has a value of 0x73, which is an example value, obtained by incrementing the Identifier value in the Authorization Request. The Length field has value 0x00d0 (208), which is the number of octets that follow the Length field.

The first attribute is the CM Identification. This is a compound attribute, identical to that in the Authorization Request.

The second attribute is the Key Sequence Number, which identifies the authorization key. The value is identical to that in the Authorization Reply.

The third attribute is the SAID for which a key is being requested. This SAID value was contained in the Authorization Reply.

The final attribute is the HMAC Digest. The digest consists of 20 octets. It is computed using the upstream message authentication key. The digest is calculated over all octets of the Key Request packet, excluding the 23 octets of the HMAC Digest attribute itself. Details of the digest calculation are given below.

I.5.1 HMAC Digest Details

The HMAC digest is computed using the HMAC authentication method defined in [RFC 2104], with SHA-1 as the hash function. Example calculations of HMAC using SHA-1 are presented in [RFC 2202].

The discussion here represents an HMAC calculation using a table that shows the key, the input to the HMAC function, and the resulting HMAC digest. For reference, here is a table that describes test case #2 of the HMAC-SHA-1 examples in [RFC 2202]:

Key	4a 65 66 65
HMAC input	77 68 61 74 20 64 6f 20 79 61 20 77 61 6e 74 20 66 6f 72 20 6e 6f 74 68 69 6e 67 3f
HMAC digest	ef fc df 6a e5 eb 2f a2 d2 74 16 d5 f1 84 df 9c 25 9a 7c 79

The HMAC digest of the Key Request packet is computed using the following HMAC calculation:

Key	fe b9 f1 e2 46 a7 6d 7c a7 7b 5e b0 98 25 fd 0b 57 ca 90 c7
HMAC input	07 73 00 d0 05 00 ad 01 00 0c 30 30 30 30 30 30 31 32 33 34 35 36 02 00 03 25 53 41 03 00 06 00 00 ca 01 04 01 04 00 8c 30 81 89 02 81 81 00 e0 e0 6c 8d be b2 8b c9 f3 a6 3d a1 12 ea f7 99 f7 3d 3e fa a3 b1 e2 42 95 71 b5 71 d2 32 7a da 10 40 e2 5b 09 74 69 08 78 46 37 71 34 3e 69 a7 37 6d f8 70 1d aa a5 34 b0 33 a3 43 ac 4d eb 41 5e 0a 8a fd a6 0a 4b 09 7f 5a 18 f2 9e c2 22 a6 6b 9a 69 73 22 d5 37 c9 63 b0 88 f5 60 5d 99 16 33 54 53 30 ed 35 de 0c 87 3b 54 ba 59 22 3e b2 79 90 96 61 db f3 4a 37 18 4c 7f a8 ca ee d6 31 02 03 01 00 01 0a 00 01 07 0c 00 02 22 60
HMAC digest	86 b8 33 b7 48 9c 4b a1 51 67 44 d7 a6 e6 ca 21 33 f5 22 9e

The key is the upstream message authentication key. The input consists of all octets of the Key Request packet, excluding the HMAC Digest attribute. The octets of the digest are the contents of the HMAC Digest attribute.

I.6 Key Reply

The CMTS sends the following Key Reply:

08 73 00 68	Key Reply header
0a 00 01 07	Key Sequence Number (authorization key)
0c 00 02 22 60	SAID
0d 00 21	TEK Parameters header
08 00 08 b6 4d 54 8c 3f 6b 25 69	TEK Key
09 00 04 00 00 a8 c0	Key Lifetime
0a 00 01 02	Key Sequence Number (TEK)
0f 00 08 81 0e 52 8e 1c 5f da 1a	DES CBC IV
0d 00 21	TEK Parameters header
08 00 08 5e bd 03 aa 5e d5 e2 94	TEK Key
09 00 04 00 01 51 80	Key Lifetime
0a 00 01 03	Key Sequence Number (TEK)
0f 00 08 25 35 67 c3 09 21 8c 2c	DES CBC IV
0b 00 14 a5 e3 33 25 ea 72 f8 50 1c 2a b6 65 45 6b cc de 8b 4f 22 02	HMAC Digest

The Code field has value 0x08, which identifies this as a Key Reply packet. The Identifier has 0x73, matching the value in the Key Request. The Length field has value 0x68 (104), which is the number of octets that follow the Length field.

The Key Sequence Number attribute identifies the authorization key. It matches the value in the Key Request.

The SAID attribute identifies the SAID for with a TEK is being supplied. It matches the value in the Key Request.

Two TEK Parameters attributes are included, the first for the older generation of key parameters and the second for the newer. Each TEK Parameters attribute is a compound attribute consisting of the following sub-attributes: TEK Key, Key Lifetime, Key Sequence Number, and DES CBC IV.

The TEK Key consists of 8 octets. It contains the TEK, encrypted using triple-DES-ECB with the KEK derived from the authorization key. Details of the triple-DES-ECB calculation are given below.

The Key Lifetime sub-attribute refers to the TEK. In this example, the value for the older TEK is 0x0000a8c0 (43200) seconds, equivalent to 12 hours, and the value for the newer TEK is 0x00015180 (86400) seconds, equivalent to 24 hours.

The Key Sequence Number sub-attribute identifies the TEK. In this example, the value for the older TEK is 0x02, and the value for the newer TEK is 0x03.

The DES CBC IV sub-attribute consists of 8 octets. It specifies the Initialization Vector to be used with the TEK.

The final attribute is the HMAC Digest. It consists of 20 octets. It is computed in a manner similar to that in the Key Reply, except that the downstream message authentication key is used instead of the upstream key. Details of the HMAC calculation are given below.

After the CM processes the Key Reply packet, the CM and CMTS each share two generations of TEK and IV. Here are the values of these parameters for this example:

Older TEK	e6 60 0f d8 85 2e f5 ab
Older IV	81 0e 52 8e 1c 5f da 1a
Newer TEK	b1 d7 4f c9 64 68 f7 58
Newer IV	25 35 67 c3 09 21 8c 2c

I.6.1 TEK Encryption Details

The CMTS generates a TEK of 8 octets. In this example, the value of the TEK is:

e6 60 0f d8 85 2e f5 ab.

This is the first TEK of the Key Reply message.

The TEK is encrypted using triple-DES-ECB encryption. The encryption key is the KEK:

76 b4 d4 2f 14 98 59 6a ab fe 72 94 15 7c 7d 62.

Triple-DES-ECB encryption is described here in terms of several iterations of DES-ECB encryption or decryption. DES-ECB is defined in [FIPS 46-3].

The discussion here represents a DES-ECB encryption or decryption operation using a table that shows the key, the input, and the output. For reference, here are tables that describe the example in Table B1 of [FIPS 46-3]:

Mode	ECB encryption
Key	01 23 45 67 89 ab cd ef
DES input	4e 6f 77 20 69 73 20 74
DES output	3f a4 0e 8a 98 4d 48 15

Mode	ECB decryption
Key	01 23 45 67 89 ab cd ef
DES input	3f a4 0e 8a 98 4d 48 15
DES output	4e 6f 77 20 69 73 20 74

NOTE: [FIPS 46-3] calls for the least significant bit of each octet in the key to be adjusted so that the octet has odd parity. This is evident in the key in the above example. The BPKM protocol does not require odd parity. BPKM generates and distributes 8-octet DES keys of arbitrary parity, and it requires that implementations ignore the value of the least significant bit of each octet.

The TEK is triple-DES-ECB encrypted using the following three DES-ECB operations:

Mode	ECB encryption
Key	76 b4 d4 2f 14 98 59 6a
DES input	e6 60 0f d8 85 2e f5 ab
DES output	c3 94 31 f5 8d f9 1d bf

Mode	ECB decryption
Key	ab fe 72 94 15 7c 7d 62

DES input	c3 94 31 f5 8d f9 1d bf
DES output	44 b0 94 4e ab 04 4c 23

Mode	ECB encryption
Key	76 b4 d4 2f 14 98 59 6a
DES input	44 b0 94 4e ab 04 4c 23
DES output	b6 4d 54 8c 3f 6b 25 69

The first and third operations are DES-ECB encryption; the key for each is the first eight octets of the KEK. The second operation is DES-ECB decryption; the key is the last eight octets of the KEK. The input to the first operation is the TEK to be encrypted. The input to the second operation is the output of the first, and the input to the third operation is the output of the second. The output of the third operation is the encrypted TEK; this is conveyed in the TEK Key sub-attribute of the Key Reply message.

I.6.2 HMAC Details

The HMAC digest of the Key Reply packet is computed by a method similar to that of the Key Request packet. The key is the downstream message authentication key. Here are the details of the HMAC calculation:

Key	93 d3 9d 70 c3 b6 f5 92 c4 6b d3 92 76 46 f4 f1 90 3a 52 fd
HMAC input	08 73 00 68 0a 00 01 07 0c 00 02 22 60 0d 00 21 08 00 08 b6 4d 54 8c 3f 6b 25 69 09 00 04 00 00 a8 c0 0a 00 01 02 0f 00 08 81 0e 52 8e 1c 5f da 1a 0d 00 21 08 00 08 5e bd 03 aa 5e d5 e2 94 09 00 04 00 01 51 80 0a 00 01 03 0f 00 08 25 35 67 c3 09 21 8c 2c
HMAC digest	a5 e3 33 25 ea 72 f8 50 1c 2a b6 65 45 6b cc de 8b 4f 22 02

I.7 Packet PDU Encryption (DES)

The first 12 octets of the Packet PDU, containing the Ethernet/802.3 destination and source addresses (DA/SA), are not encrypted. The remaining octets of the Packet PDU are encrypted in this example using DES-CBC mode with special handling of residual termination blocks that are less than 64 bits. The combination of DES-CBC and residual block processing ensures that the encryption does not change the length of the packet. The encryption key is the TEK corresponding to the key sequence number of the packet's Privacy Extended Header.

This specification describes the residual block processing as follows:

The next-to-last ciphertext block is encrypted a second time, using the ECB mode of the encryption algorithm, and the least significant n bits of the result are XORed with the final n bits of the payload to generate the short final cipher block. In order for the receiver to decrypt the short final cipher block, the receiver encrypts the next-to-last ciphertext block using the ECB mode of the encryption algorithm, and XORs the left-most n bits with the short final cipher block in order to recover the short final cleartext block.

An alternative description of this procedure, which is equivalent to the description above, is as follows:

Given a final block having n bits, where n is less than the length of the defined block for the cipher, the n bits are padded up to a block of the correct length by appending bits of arbitrary value to the right of the n payload bits. The resulting block is encrypted using the CFB<n> mode (where <n> is the length, in bits, of the block for the cipher in question) with the next-to-last ciphertext block serving as initialization vector for the CFB<n> operation. The leftmost n bits of the resulting ciphertext are used as the short cipher block. In the special case where the PDU is less than the length of the block for the cipher, the procedure is the same as for a short final block, with the provided initialization vector serving as the initialization vector for the CFB<n> operation.

The alternative description produces the same ciphertext as does the description in the body of this specification. In the alternative description, however, no mention is made of combining ECB encryption with XORs. These

operations are internal to CFB, just as they are internal to CBC. The alternative description is convenient here because it allows residual block processing to be illustrated using CFB examples in [FIPS 46-3].

The Packet PDU includes the DA, SA, and Type/Len fields. In the examples here, no effort is made to use correct values for these fields. As a result, the examples here are not valid packets suitable for transmission. The intent of the examples is to illustrate encryption details only.

In these examples, the TEK and IV are taken from the example Key Reply packet described above.

I.7.1 CBC Only

When the number of octets to be encrypted is a multiple of 8, the encryption mode is DES-CBC as defined in [FIPS 46-3]. The encryption key and IV are as conveyed in the Key Reply packet.

The discussion here represents a DES-CBC encryption using a table that shows the key, IV, plaintext input, and ciphertext output. For reference, here is a table that describes the example in Table C1 of [FIPS 46-3]:

Mode	CBC
Key	01 23 45 67 89 ab cd ef
IV	12 34 56 78 90 ab cd ef
Plaintext	4e 6f 77 20 69 73 20 74 68 65 20 74 69 6d 65 20
Ciphertext	e5 c7 cd de 87 2b f2 7c 43 e9 34 00 8c 38 9c 0f

Suppose that the PDU, prior to encryption, is as follows:

DA	01 02 03 04 05 06
SA	f1 f2 f3 f4 f5 f6
Type/Len	00 01
User Data	02 03 04 05 06 07 08 09 0a 0b
CRC	88 41 65 06

The DES-CBC encryption is performed as follows:

Mode	CBC
Key	e6 60 0f d8 85 2e f5 ab
IV	81 0e 52 8e 1c 5f da 1a
Plaintext	00 01 02 03 04 05 06 07 08 09 0a 0b 88 41 65 06
Ciphertext	0d da 5a cb d0 5e 55 67 9f 04 d1 b6 41 3d 4e ed

The PDU, after encryption, looks like this:

DA	01 02 03 04 05 06
SA	f1 f2 f3 f4 f5 f6
Type/Len	0d da
User Data	5a cb d0 5e 55 67 9f 04 d1 b6
CRC	41 3d 4e ed

I.7.2 CBC with Residual Block Processing

When the number of octets to be encrypted is greater than 8 and is not a multiple of 8, the encryption mode is a combination of DES-CBC and DES-CFB64.

Encryption begins in DES-CBC mode. DES-CBC is used to process as many complete DES blocks as are present. The encryption key and IV are as conveyed in the Key Reply packet.

After the DES-CBC encryption, there is some number of octets that have not been encrypted. These octets are encrypted using DES-CFB64 mode. DES-CFB64 is the "64-bit Cipher Feedback Mode" defined in [FIPS 46-3]. The encryption key is as in the Key Reply packet. The IV is the last 8 octets of ciphertext produced by the DES-CBC processing.

The example here represents a DES-CFB64 encryption using a table that shows the key, IV, plaintext input, and ciphertext output. For reference, here is a table that describes the example in Table D3 of [FIPS 46-3]:

Mode	CFB64
Key	01 23 45 67 89 ab cd ef
IV	12 34 56 78 90 ab cd ef
Plaintext	4e 6f 77 20 69 73 20 74 68 65 20 74 69 6d 65 20
Ciphertext	f3 09 62 49 c7 f4 6e 51 a6 9e 83 9b 1a 92 f7 84

Suppose that the PDU, prior to encryption, is as follows:

DA	01 02 03 04 05 06
SA	f1 f2 f3 f4 f5 f6
Type/Len	00 01
User Data	02 03 04 05 06 07 08 09 0a 0b 0c 0d 0e
CRC	91 d2 d1 9f

The total number of octets to be encrypted is 19. The first 16 octets are processed using DES-CBC encryption, and the last 3 octets using DES-CFB64 encryption.

The DES-CBC encryption is performed as follows:

Mode	CBC
Key	e6 60 0f d8 85 2e f5 ab
IV	81 0e 52 8e 1c 5f da 1a
Plaintext	00 01 02 03 04 05 06 07 08 09 0a 0b 0c 0d 0e 91
Ciphertext	0d da 5a cb d0 5e 55 67 51 47 46 86 8a 71 e5 77

The DES-CFB64 encryption is performed as follows:

Mode	CFB64
Key	e6 60 0f d8 85 2e f5 ab
IV	51 47 46 86 8a 71 e5 77
Plaintext	d2 d1 9f 00 00 00 00 00
Ciphertext	ef ac 88 e8 ee 80 33 14

The key is the same as used for the DES-CBC encryption operation. The IV is the last 8 octets of ciphertext generated by the DES-CBC operation.

Notice that 5 octets of value 0 have been appended to the 3 plaintext octets. The values of these appended plaintext octets have no effect on the values of the first 3 ciphertext octets, which are the only ciphertext octets of interest. Arbitrary values can be used for the appended plaintext octets.

The PDU, after encryption, looks like this:

DA	01 02 03 04 05 06
SA	f1 f2 f3 f4 f5 f6
Type/Len	0d da
User Data	5a cb d0 5e 55 67 51 47 46 86 8a 71 e5
CRC	77 ef ac 88

I.7.3 Runt Frame

When the number of octets to be encrypted is less than 8, the encryption mode is DES-CFB64. The encryption key and IV are as conveyed in the Key Reply packet.

Suppose that the PDU, prior to encryption, is as follows:

DA	01 02 03 04 05 06
SA	f1 f2 f3 f4 f5 f6
Type/Len	00 01
User Data	02
CRC	88 ee 59 7e

The DES-CFB64 encryption is performed as follows:

Mode	CFB64
Key	e6 60 0f d8 85 2e f5 ab
IV	81 0e 52 8e 1c 5f da 1a
Plaintext	00 01 02 88 ee 59 7e 00
Ciphertext	17 86 a8 03 a0 85 75 01

An octet of value 0 has been appended to the 7 plaintext octets. The value of this appended plaintext octet has no effect on the values of the first 7 ciphertext octets, which are the only ciphertext octets of interest. An arbitrary value can be used for the appended plaintext octet.

The PDU, after encryption, looks like this:

DA	01 02 03 04 05 06
SA	f1 f2 f3 f4 f5 f6
Type/Len	17 86
User Data	a8
CRC	03 a0 85 75

I.7.4 40-bit Key

The BPKM protocol always generates and distributes 56-bit DES keys. When 40-bit encryption is required, the 56-bit DES key is converted within an implementation to a 40-bit key by masking off (to zero) 16 of the 56 bits of a TEK.

A TEK has 8 octets, each octet containing 7 bits of key and 1 parity bit. Here is the procedure for converting a TEK to a 40-bit key:

- the first two octets of the TEK are set to 0;
- the two most significant bits of the third octet of the TEK are set to 0;
- the remaining five octets of the TEK are unchanged.

For example, if the TEK distributed by the BPKM protocol is:

ff ff ff ff ff ff ff ff,

then the conversion to 40 bits yields the TEK

00 00 3f ff ff ff ff ff.

Except for this conversion of the TEK value, the procedure for 40-bit encryption of a Packet PDU is identical to the case of 40-bit encryption.

To illustrate 40-bit encryption, a previous example of Packet PDU is repeated here, with the TEK converted to 40 bits.

Suppose that the Packet PDU, prior to encryption, is as follows:

DA	01 02 03 04 05 06
SA	f1 f2 f3 f4 f5 f6
Type/Len	00 01
User Data	02 03 04 05 06 07 08 09 0a 0b 0c 0d 0e
CRC	91 d2 d1 9f

The total number of octets to be encrypted is 19. The first 16 octets are processed using DES-CBC encryption, and the last 3 octets using DES-CFB64 encryption.

The DES-CBC encryption is performed as follows:

Mode	CBC
Key	00 00 0f d8 85 2e f5 ab
IV	81 0e 52 8e 1c 5f da 1a
Plaintext	00 01 02 03 04 05 06 07 08 09 0a 0b 0c 0d 0e 91
Ciphertext	44 c8 4a 41 14 67 56 a2 dc 64 8f b0 dc 1e 1e 86

The key is the TEK conveyed in the Key Reply message, converted to a 40-bit key. The IV is as conveyed in the Key Reply message.

The DES-CFB64 encryption is performed as follows:

Mode	CFB64
Key	00 00 0f d8 85 2e f5 ab
IV	dc 64 8f b0 dc 1e 1e 86

Plaintext	d2 d1 9f 00 00 00 00 00
Ciphertext	f1 42 aa a3 e4 9b eb 29

The key is the same as used for the DES-CBC encryption operation. The IV is the last 8 octets of ciphertext generated by the DES-CBC operation.

The Packet PDU, after encryption, looks like this:

DA	01 02 03 04 05 06
SA	f1 f2 f3 f4 f5 f6
Type/Len	44 c8
User Data	4a 41 14 67 56 a2 dc 64 8f b0 dc 1e 1e
CRC	86 f1 42 aa

I.8 Encryption of PDU with Payload Header Suppression (DES)

These examples show how encryption is applied to a PDU when Payload Header Suppression (PHS) is applied. The examples use an RTP [RFC 3550] Voice over IP payload. In the examples, no effort is made to use correct values for the fields of the PDU. As a result, the examples here are not valid packets suitable for transmission. The intent of the examples is to illustrate encryption details only.

I.8.1 Downstream

Suppose that the PDU, after PHS and prior to encryption, is as follows:

DA	01 02 03 04 05 06
SA	f1 f2 f3 f4 f5 f6
RTP header	21 22 23 24 25 26 27 28 29 2a 2b 2c
Voice data	31 32 33 34 35 36 37 38 39 3a
CRC	93 86 b3 b9

PHS has removed the Type/Len field that would otherwise be included in the Ethernet/802.3 header. The User Data consists of the RTP header and the voice data.

Encryption is applied beginning with the first octet of the RTP header and ending with the last octet of the CRC, as follows:

Mode	CBC
Key	e6 60 0f d8 85 2e f5 ab
IV	81 0e 52 8e 1c 5f da 1a
Plaintext	21 22 23 24 25 26 27 28 29 2a 2b 2c 31 32 33 34 35 36 37 38 39 3a 93 86
Ciphertext	b4 55 da c8 39 1e 0c ed 15 cf b5 79 0a c3 24 5e cf 0f 52 c0 69 f5 f6 6e

Mode	CFB64
Key	e6 60 0f d8 85 2e f5 ab

IV	cf 0f 52 c0 69 f5 f6 6e
Plaintext	b3 b9 00 00 00 00 00 00
Ciphertext	3e 31 de ea 96 6a 88 6b

The PDU, after encryption, looks like this:

DA	01 02 03 04 05 06
SA	f1 f2 f3 f4 f5 f6
RTP header	b4 55 da c8 39 1e 0c ed 15 cf b5 79
Voice data	0a c3 24 5e cf 0f 52 c0 69 f5
CRC	f6 6e 3e 31

1.8.2 Upstream

Suppose that the PDU, after PHS and prior to encryption, is as follows:

RTP header	21 22 23 24 25 26 27 28 29 2a 2b 2c
Voice data	31 32 33 34 35 36 37 38 39 3a
CRC	65 cf fe 89

PHS has removed the DA, SA, and Type/Len fields that would otherwise be included in the Ethernet/802.3 header. The User Data consists of the RTP header and the voice data. The first 12 octets of the User Data are not encrypted.

Encryption is applied beginning with the first octet of the voice data and ending with the last octet of the CRC, as follows:

Mode	CBC
Key	e6 60 0f d8 85 2e f5 ab
IV	81 0e 52 8e 1c 5f da 1a
Plaintext	31 32 33 34 35 36 37 38
Ciphertext	d6 88 87 66 1f 66 04 79

Mode	CFB64
Key	e6 60 0f d8 85 2e f5 ab
IV	d6 88 87 66 1f 66 04 79
Plaintext	39 3a 65 cf fe 89 00 00
Ciphertext	c0 07 20 8e 3b 0b b1 b9

The PDU, after encryption, looks like this:

RTP header	21 22 23 24 25 26 27 28 29 2a 2b 2c
Voice data	d6 88 87 66 1f 66 04 79 c0 07
CRC	20 8e 3b 0b

I.9 Fragmented Packet Encryption (DES)

When a packet is fragmented, each fragment is independently encrypted using CBC mode with residual block processing. The TEK and IV for each fragment are the same TEK and IV that are used for encrypting an unfragmented PDU. All octets of a fragment are encrypted, including the 12 octets carrying the Ethernet/802.3 destination and source addresses (DA/SA) of the Packet PDU.

In the example here, no effort is made to use meaningful values for the fields of the packet. As a result, the example here is not a valid packet suitable for transmission. The intent of the example is to illustrate encryption details only.

In this example, the TEK and IV are taken from the example Key Reply packet described above.

Suppose that packet is divided into two fragments, as follows:

Fragment 1 payload	01 02 03 04 05 06 f1 f2 f3 f4 f5 f6 00 01 02 03 04 05
Fragment 1 CRC	b4 2b 6d d4

Fragment 2 payload	06 07 08 09 0a 0b 0c 0d
Fragment 2 CRC	48 34 45 36

The first fragment is encrypted using DES-CBC and DES-CFB64, as follows:

Mode	CBC
Key	e6 60 0f d8 85 2e f5 ab
IV	81 0e 52 8e 1c 5f da 1a
Plaintext	01 02 03 04 05 06 f1 f2 f3 f4 f5 f6 00 01 02 03
Ciphertext	47 41 0f 4f fd 78 47 6e c8 1a 67 4e 26 0c 20 c5

Mode	CFB64
Key	e6 60 0f d8 85 2e f5 ab
IV	c8 1a 67 4e 26 0c 20 c5
Plaintext	04 05 b4 2b 6d d4 00 00
Ciphertext	56 6d 5c 58 2f 56 dc 39

The first fragment, after encryption, looks like this:

Fragment 1 payload	47 41 0f 4f fd 78 47 6e c8 1a 67 4e 26 0c 20 c5 56 6d
Fragment 1 CRC	5c 58 2f 56

The second fragment is encrypted using DES-CBC and DES-CFB64, as follows:

Mode	CBC
Key	e6 60 0f d8 85 2e f5 ab
IV	81 0e 52 8e 1c 5f da 1a
Plaintext	06 07 08 09 0a 0b 0c 0d
Ciphertext	d8 55 0f 59 9d 19 d9 c6

Mode	CFB64
Key	e6 60 0f d8 85 2e f5 ab
IV	d8 55 0f 59 9d 19 d9 c6
Plaintext	48 34 45 36 00 00 00 00
Ciphertext	b4 5f 3e 95 0e e4 d7 df

The second fragment, after encryption, looks like this:

Fragment 2 payload	d8 55 0f 59 9d 19 d9 c6
Fragment 2 CRC	b4 5f 3e 95

I.10 Packet PDU Encryption (AES)

The first 12 octets of the Packet PDU, containing the Ethernet/802.3 destination and source addresses (DA/SA), are not encrypted. The remaining octets of the Packet PDU are encrypted in this example using AES-CBC mode with special handling of residual termination blocks that are less than 128 bits. The combination of AES-CBC and residual block processing ensures that the encryption does not change the length of the packet. The encryption key is the TEK corresponding to the key sequence number of the packet's Privacy Extended Header.

This specification describes the residual block processing as follows:

The next-to-last ciphertext block is encrypted a second time, using the ECB mode of the encryption algorithm, and the least significant n bits of the result are XORed with the final n bits of the payload to generate the short final cipher block. In order for the receiver to decrypt the short final cipher block, the receiver encrypts the next-to-last ciphertext block using the ECB mode of the encryption algorithm, and XORs the left-most n bits with the short final cipher block in order to recover the short final cleartext block.

An alternative description of this procedure, which is equivalent to the description above, is as follows:

Given a final block having n bits, where n is less than the length of the defined block for the cipher, the n bits are padded up to a block of the correct length by appending bits of arbitrary value to the right of the n payload bits. The resulting block is encrypted using the CFB< n > mode (where < n > is the length, in bits, of the block for the cipher in question) with the next-to-last ciphertext block serving as initialization vector for the CFB< n > operation. The leftmost n bits of the resulting ciphertext are used as the short cipher block. In the special case where the PDU is less than the length of the block for the cipher, the procedure is the same as for a short final block, with the provided initialization vector serving as the initialization vector for the CFB< n > operation.

The alternative description produces the same ciphertext as does the description in the body of this specification. In the alternative description, however, no mention is made of combining ECB encryption with XORs. These operations are internal to CFB, just as they are internal to CBC. The alternative description is convenient here because it allows residual block processing to be illustrated using CFB examples in [FIPS 46-3].

The Packet PDU includes the DA, SA, and Type/Len fields. In the examples here, no effort is made to use correct values for these fields. As a result, the examples here are not valid packets suitable for transmission. The intent of the examples is to illustrate encryption details only.

In these examples, the TEK and IV are taken from the example Key Reply packet described above.

I.10.1 CBC Only

When the number of octets to be encrypted is a multiple of 16, the encryption mode is AES-CBC as defined in [FIPS 46-3]. The encryption key and IV are as conveyed in the Key Reply packet.

The following table represents an example of AES-CBC encryption:

Mode	CBC
Key	01 23 45 67 89 ab cd ef 01 23 45 67 89 ab cd ef
IV	12 34 56 78 90 ab cd ef 12 34 56 78 90 ab cd ef
Example Plaintext	4e 6f 77 20 69 73 20 74 68 65 20 74 69 6d 65 20
Equivalent Ciphertext	7d 51 ac d5 b3 79 ac 2f 8f 46 f3 1c af d7 91 b4

Suppose that a PDU, prior to encryption, is as follows:

DA	01 02 03 04 05 06
SA	f1 f2 f3 f4 f5 f6
Type/Len	00 01
User Data	02 03 04 05 06 07 08 09 0a 0b
CRC	88 41 65 06

The DA and SA fields are not included in the encryption process, so the AES-CBC encryption is performed as follows:

Mode	CBC
Key	e6 60 0f d8 85 2e f5 ab e6 60 0f d8 85 2e f5 ab
IV	81 0e 52 8e 1c 5f da 1a 81 0e 52 8e 1c 5f da 1a
Plaintext	00 01 02 03 04 05 06 07 08 09 0a 0b 88 41 65 06
Ciphertext	5a 79 ba ca 6 ^a 2d 38 99 11 76 e3 11 9f f1 19 c7

The PDU, after encryption, looks like this:

DA	01 02 03 04 05 06
SA	f1 f2 f3 f4 f5 f6
Type/Len	5a 79
User Data	ba ca 6a 2d 38 99 11 76 e3 11
CRC	9f f1 19 c7

I.10.2 CBC with Residual Block Processing

When the number of octets to be encrypted is greater than 16 and is not a multiple of 16, the encryption mode is a combination of AES-CBC and AES-CFB128.

Encryption begins in AES-CBC mode. AES-CBC is used to process as many complete AES blocks as are present. The encryption key and IV are as conveyed in the Key Reply packet.

After the AES-CBC encryption, there is some number of octets that have not been encrypted. These octets are encrypted using AES-CFB128 mode. The encryption key is as in the Key Reply packet. The IV is the last 16 octets of ciphertext produced by the AES-CBC processing.

The following table represents an example of AES-CFB128 encryption:

Mode	AES-CFB128
Key	01 23 45 67 89 ab cd ef 01 23 45 67 89 ab cd ef
IV	12 34 56 78 90 ab cd ef 12 34 56 78 90 ab cd ef
Plaintext	4e 6f 77 20 69 73 20 74 68 65 20 74 69 6d 65 20
Ciphertext	43 bc 0a d0 fc 8d 93 ff 80 e0 bf f1 41 fc 67 08

Suppose that the PDU, prior to encryption, is as follows:

DA	01 02 03 04 05 06
SA	f1 f2 f3 f4 f5 f6
Type/Len	00 01
User Data	02 03 04 05 06 07 08 09 0a 0b 0c 0d 0e
CRC	91 d2 d1 9f

The total number of octets to be encrypted is 19. The first 16 octets are processed using AES-CBC encryption, and the last 3 octets using AES-CFB128 encryption.

The AES-CBC encryption is performed as follows:

Mode	AES-CBC
Key	e6 60 0f d8 85 2e f5 ab e6 60 0f d8 85 2e f5 ab
IV	81 0e 52 8e 1c 5f da 1a 81 0e 52 8e 1c 5f da 1a
Plaintext	00 01 02 03 04 05 06 07 08 09 0a 0b 0c 0d 0e 91
Ciphertext	9d d1 67 4b ba 61 10 1b 56 75 64 74 36 4f 10 1d

The AES-CFB128 encryption is performed as follows:

Mode	CFB128
Key	e6 60 0f d8 85 2e f5 ab e6 60 0f d8 85 2e f5 ab
IV	9d d1 67 4b ba 61 10 1b 56 75 64 74 36 4f 10 1d
Plaintext	d2 d1 9f 00 00 00 00 00 00 00 00 00 00 00 00 00 00
Ciphertext	44 d4 73 dd 83 9c ee 46 4c ff 83 b7 27 96 d6 55

The key is the same as used for the AES-CBC encryption operation. The IV is the last 16 octets of ciphertext generated by the AES-CBC operation.

Notice that 13 octets of value 0 have been appended to the 3 plaintext octets. The values of these appended plaintext octets have no effect on the values of the first 3 ciphertext octets, which are the only ciphertext octets of interest. Arbitrary values can be used for the appended plaintext octets.

The PDU, after encryption, looks like this:

DA	01 02 03 04 05 06
SA	f1 f2 f3 f4 f5 f6
Type/Len	9d d1
User Data	67 4b ba 61 10 1b 56 75 64 74 36 4f 10
CRC	1d 44 d4 73

I.10.3 Runt Frame

When the number of octets to be encrypted is less than 16, the encryption mode is AES-CFB128. The encryption key and IV are as conveyed in the Key Reply packet.

Suppose that the PDU, prior to encryption, is as follows:

DA	01 02 03 04 05 06
SA	f1 f2 f3 f4 f5 f6
Type/Len	00 01
User Data	02
CRC	88 ee 59 7e

The AES-CFB128 encryption is performed as follows:

Mode	CFB128
Key	e6 60 0f d8 85 2e f5 ab e6 60 0f d8 85 2e f5 ab
IV	81 0e 52 8e 1c 5f da 1a 81 0e 52 8e 1c 5f da 1a
Plaintext	00 01 02 88 ee 59 7e 00 00 00 00 00 00 00 00
Ciphertext	fc 68 a3 55 60 37 dc d7 4c 6e 5c 5e 50 d5 98 b2

An octet of value 0 has been appended to the 7 plaintext octets. The value of this appended plaintext octet has no effect on the values of the first 7 ciphertext octets, which are the only ciphertext octets of interest. An arbitrary value can be used for the appended plaintext octet.

The PDU, after encryption, looks like this:

DA	01 02 03 04 05 06
SA	f1 f2 f3 f4 f5 f6
Type/Len	fc 68
User Data	a3
CRC	55 60 37 dc

I.11 Encryption of PDU with Payload Header Suppression (AES)

These examples show how encryption is applied to a PDU when Payload Header Suppression (PHS) is applied. The examples use an RTP [RFC 3550] Voice over IP payload with the Ethernet Type/Length field and the IP and UDP headers suppressed. In the examples, no effort is made to use correct values for the fields of the PDU. As a

result, the examples here are not valid packets suitable for transmission. The intent of the examples is to illustrate encryption details only.

I.11.1 Downstream

Suppose that the PDU, after PHS and prior to encryption, is as follows:

DA	01 02 03 04 05 06
SA	f1 f2 f3 f4 f5 f6
RTP header	21 22 23 24 25 26 27 28 29 2a 2b 2c
Voice data	31 32 33 34 35 36 37 38 39 3a
CRC	93 86 b3 b9

PHS has removed the Type/Len field that would otherwise be included in the Ethernet/802.3 header. The User Data consists of the RTP header and the voice data. Encryption is applied beginning with the first octet of the RTP header and ending with the last octet of the CRC, as follows:

Mode	AES-CBC
Key	e6 60 0f d8 85 2e f5 ab e6 60 0f d8 85 2e f5 ab
IV	81 0e 52 8e 1c 5f da 1a 81 0e 52 8e 1c 5f da 1a
Plaintext	21 22 23 24 25 26 27 28 29 2a 2b 2c 31 32 33 34
Ciphertext	b6 d6 90 a5 8e 75 1d 00 9e 70 4f 1f 76 b1 5d 88

Mode	AES-CFB128
Key	e6 60 0f d8 85 2e f5 ab e6 60 0f d8 85 2e f5 ab
IV	b6 d6 90 a5 8e 75 1d 00 9e 70 4f 1f 76 b1 5d 88
Plaintext	35 36 37 38 39 3a 93 86 b3 b9 00 00 00 00 00 00
Ciphertext	26 25 03 a4 e5 01 d7 ab d9 9e 9a 63 00 22 44 36

The PDU, after encryption, looks like this:

DA	01 02 03 04 05 06
SA	f1 f2 f3 f4 f5 f6
RTP header	b6 d6 90 a5 8e 75 1d 00 9e 70 4f 1f
Voice data	76 b1 5d 88 af 4f a8 b4 ba 8a
CRC	6f 17 6b 7a

I.11.2 Upstream

Suppose that the PDU, after PHS and prior to encryption, is as follows:

RTP header	21 22 23 24 25 26 27 28 29 2a 2b 2c
Voice data	31 32 33 34 35 36 37 38 39 3a 3b 3c 3d 3e
CRC	65 cf fe 89

PHS has removed the DA, SA, and Type/Len fields that would otherwise be included in the Ethernet/802.3 header as well as the IP and UDP headers. The User Data consists of the RTP header and the voice data. The first 12 octets of the User Data are not encrypted.

Encryption is applied beginning with the first octet of the voice data and ending with the last octet of the CRC, as follows:

Mode	AES-CBC
Key	e6 60 0f d8 85 2e f5 ab e6 60 0f d8 85 2e f5 ab
IV	81 0e 52 8e 1c 5f da 1a 81 0e 52 8e 1c 5f da 1a
Plaintext	31 32 33 34 35 36 37 38 39 3a 3b 3c 3d 3e 65 cf
Ciphertext	ce 8c e2 55 1c e3 d2 6c 3f 06 f6 e9 66 e7 f7 d3

Mode	AES-CFB128
Key	e6 60 0f d8 85 2e f5 ab e6 60 0f d8 85 2e f5 ab
IV	ce 8c e2 55 1c e3 d2 6c 3f 06 f6 e9 66 e7 f7 d3
Plaintext	fe 89 00 00 00 00 00 00 00 00 00 00 00 00 00
Ciphertext	4e 4e 1f c5 36 37 3e d7 bc 82 ad 52 8e 6c 05 dd

The PDU, after encryption, looks like this:

RTP header	21 22 23 24 25 26 27 28 29 2a 2b 2c
Voice data	ce 8c e2 55 1c e3 d2 6c 3f 06 f6 e9 66 e7
CRC	f7 d3 4e 4e

I.12 Fragmented Packet Encryption (AES)

When a packet is fragmented, each fragment is independently encrypted using CBC mode with residual block processing. The TEK and IV for each fragment are the same TEK and IV that are used for encrypting an unfragmented PDU. All octets of a fragment are encrypted, including the 12 octets carrying the Ethernet/802.3 destination and source addresses (DA/SA) of the Packet PDU.

In the example here, no effort is made to use meaningful values for the fields of the packet. As a result, the example here is not a valid packet suitable for transmission. The intent of the example is to illustrate encryption details only.

In this example, the TEK and IV are taken from the example Key Reply packet described above.

Suppose that packet is divided into two fragments, as follows:

Fragment 1 payload	01 02 03 04 05 06 f1 f2 f3 f4 f5 f6 00 01 02 03 04 05
Fragment 1 CRC	b4 2b 6d d4
Fragment 2 payload	06 07 08 09 0a 0b 0c 0d 06 07 08 09 0a 0b 0c 0d
Fragment 2 CRC	48 34 45 36

The first fragment is encrypted using AES-CBC and AES-CFB128, as follows:

Mode	AES-CBC
Key	e6 60 0f d8 85 2e f5 ab e6 60 0f d8 85 2e f5 ab
IV	81 0e 52 8e 1c 5f da 1a 81 0e 52 8e 1c 5f da 1a
Plaintext	01 02 03 04 05 06 f1 f2 f3 f4 f5 f6 00 01 02 03
Ciphertext	63 48 92 62 01 a9 88 08 df a3 55 30 7b 99 65 1e

Mode	AES-CFB128
Key	e6 60 0f d8 85 2e f5 ab e6 60 0f d8 85 2e f5 ab
IV	63 48 92 62 01 a9 88 08 df a3 55 30 7b 99 65 1e
Plaintext	04 05 b4 2b 6d d4 00 00 00 00 00 00 00 00 00
Ciphertext	e9 ad be e7 be d5 88 9d 35 ff 76 ce 29 26 98 04

The first fragment, after encryption, looks like this:

Fragment 1 payload	63 48 92 62 01 a9 88 08 df a3 55 30 7b 99 65 1e e9 ad
Fragment 1 CRC	be e7 be d5

The second fragment is encrypted using AES-CBC and AES-CFB128, as follows:

Mode	AES-CBC
Key	e6 60 0f d8 85 2e f5 ab e6 60 0f d8 85 2e f5 ab
IV	81 0e 52 8e 1c 5f da 1a 81 0e 52 8e 1c 5f da 1a
Plaintext	06 07 08 09 0a 0b 0c 0d 06 07 08 09 0a 0b 0c 0d
Ciphertext	62 f0 15 15 b4 18 d5 55 f7 52 5e 42 51 0b 77 e8

Mode	CFB128
Key	e6 60 0f d8 85 2e f5 ab e6 60 0f d8 85 2e f5 ab
IV	62 f0 15 15 b4 18 d5 55 f7 52 5e 42 51 0b 77 e8
Plaintext	48 34 45 36 00 00 00 00 00 00 00 00 00 00 00
Ciphertext	36 3f 5e 89 9a f7 40 89 85 7a 95 cd 47 d7 2b 1a

The second fragment, after encryption, looks like this:

Fragment 2 payload	62 f0 15 15 b4 18 d5 55 f7 52 5e 42 51 0b 77 e8
Fragment 2 CRC	36 3f 5e 89

I.13 Secure Software Download CM Code File

The code file example in this section was created using example versions of the Manufacturer CVC and CVC CA certificate.

Table I-1 - New PKI Code File Example

	PKCS #7 Digital Signature {
0000: 30 82 0B 8D	ContentInfo header, len 2957(0xb8d)
0004: 06 09 2A 86 48 86 F7 0D 01 07 02	ContentType=signedData (OID: 1 2 840 113549 1 7 2)
0015: A0 82 0B 7E	[0] EXPLICIT, len 2942 (0xb7e)
0019: 30 82 0B 7A	SignedData header, len 2938 (0xb7a)
0023: 02 01 01	Version=1
0026: 31 0F 0028: 30 0D 0030: 06 09 60 86 48 01 65 03 04 02 01 0041: 05 00	SET OF DigestAlgorithmIdentifier DigestAlgorithmIdentifier header Algorithm=SHA-256 (OID: 2 16 840 1 101 3 4 2 1) Parameters=NULL
0043: 30 0B 0045: 06 09 2A 86 48 86 F7 0D 01 07 01	ContentInfo header contentType=data (OID: 1 2 840 113549 1 7 1)
0056: A0 82 09 43	Certificates Length = 2371(0x0943) Note: This field length includes the size(s) of all enclosed CVCs. If both Manufacturer and Co-signer CVCs are present, then this size is the total size of the signed Manufacturer CVC plus the total size of the signed Co-signer CVC.

<pre> 0060: 30 82 03 F9 30 82 02 61 A0 03 02 01 02 02 08 05 05 05 05 05 05 05 05 30 0D 06 09 2A 86 48 86 F7 0D 01 01 0B 05 00 30 6C 31 0B 30 09 06 03 55 04 06 13 02 55 53 31 12 30 10 06 03 55 04 0A 13 09 43 61 62 6C 65 4C 61 62 73 31 11 30 0F 06 03 55 04 0B 13 08 43 56 43 20 43 41 30 31 31 36 30 34 06 03 55 04 03 13 2D 45 78 61 6D 70 6C 65 20 43 61 62 6C 65 4C 61 62 73 20 43 56 43 20 43 65 72 74 69 66 69 63 61 74 69 6F 6E 20 41 75 74 68 6F 72 69 74 79 30 1E 17 0D 31 34 30 39 31 37 31 38 32 31 35 34 5A 17 0D 32 34 30 39 31 37 31 38 32 31 35 34 5A 30 50 31 0B 30 09 06 03 55 04 06 13 02 55 53 31 11 30 0F 06 03 55 04 0A 13 08 42 72 6F 61 64 63 6F 6D 31 2E </pre>	<p>Manufacturer Code Verification Certificate (CVC) (Required for all code files) Binary (DER) format CVC Begins at offset 60 (0x3C) CVC Ends at offset 1080(0x438) CVC Length 1021(0x3FD) See table I.13.2 for details of CVC.</p>
--	---

30 2C 06 03 55 04 03 13 25 45 78 61 6D 70 6C 65 20 43 6F 64 65 20 56 65 72 69 66 69 63 61 74 69 6F 6E 20 43 65 72 74 69 66 69 63 61 74 65 30 82 01 22 30 0D 06 09 2A 86 48 86 F7 0D 01 01 01 05 00 03 82 01 0F 00 30 82 01 0A 02 82 01 01 00 E1 E7 F2 0A B4 B1 B6 A7 DD 0E 8E A7 6E DF B2 56 63 F4 6B 9C E9 40 D9 85 2B 5A 7B 98 4B F6 89 FE A8 39 7A FD F8 B8 D8 40 F0 C8 7E 0B 6F 9B 43 CD 28 99 7D 53 32 CD 6F D5 15 DD 2B ED 2D 4B B9 8F 05 A7 B6 C5 53 63 79 9B 76 8B 8F 9E DF 42 59 28 16 1B A8 EF BF 0C 36 28 3D 56 C4 FF 73 4B 56 6A 3A CE 27 36 12 33 B0 79 E5 13 6E 36 68 11 07 8D E3 99 69 22 F4 54 7C A2 CE 5A E2 38 73 2E 79 0E 17 AE 86 57 01 27 2E 50 13 BD 54 E5 36 4E 71 40 82 40 CB 8D 3B 03 92 5E 06 3F 20 DB 73 58 A3 72 3F 8F B8 F5 A5 D9 0D 22 99 DA 89 DC 2B A3 F4 6C 53 DD B2 06 73 CA 22 14 08 59 19 05 D6 92 49 56 5C 60 1D 9F 35 D2 53 DB E2 81 0D 94 B2 16 3B F1 AF 04 48 9C 41 54 07 43 18 65 DA C3 A2 A8 6C 2A A1 8D 16 51 55 16 EA 14 3C 5C B0 2F 8F 0A F9 4E 3E 7E 12 42 4B DD 7D 25 06 B6 0E 99 1E 7F 16 33 02 03 01 00 01 A3 3B 30 39 30 16 06 03 55 1D 25 01 01 FF 04 0C 30 0A 06 08 2B 06 01 05 05 07 03 03 30 1F 06 03 55 1D 23 04 18 30 16 80 14 BA 30 B0 DF 3A 7F 34 62 7C B7 A6 95 A3 0F 81 00 32 01 CC	CVC (continued)
--	-----------------

<pre> B0 30 0D 06 09 2A 86 48 86 F7 0D 01 01 0B 05 00 03 82 01 81 00 3F D3 6A F3 4B EA 89 02 C8 27 9C 43 AE 55 AF E5 7A A2 23 03 4A 29 69 78 D5 4D 4B AA E8 B2 7E 42 99 66 BC C9 82 A3 ED D2 F0 7F 77 22 E8 D7 C5 AD A0 58 DB 43 DA 6D 4B D6 1D 6E 73 38 0D 60 30 C0 9A 5F 22 62 7C BA F1 CE 44 B4 71 E6 72 D0 19 B5 5E 39 46 A9 13 00 18 7F 43 7A ED 31 A3 E5 7C FD 8B EE 4D AC 0D 46 09 59 BB 8C 6B A9 DA 44 62 35 65 4D 34 3E 41 A5 52 FE D2 A9 A2 FC 19 DF F3 70 9E 92 CD C2 24 32 BB 8A 58 45 12 17 B6 E2 AF 19 2D F5 3C 60 31 2F 71 87 F4 CA EC 7F C9 4B F4 3C 18 30 C5 B0 CF CC 45 EB C2 82 D9 3A 6D DD A4 8D E4 CD 7D 50 AA 7B FA 54 6A 36 D1 48 39 D7 D5 B2 AE 75 7D 76 DC F7 88 A5 F4 D6 C0 2D AD D6 80 5B 32 EC EA 47 20 44 A9 60 87 C4 8F 16 3F FC 83 48 B2 39 E8 46 FD 0A 91 AC C0 DC C7 7A 92 00 E0 58 0C CA 96 EB E0 BC 0F FA 9F 6A 19 D3 9E 0F 23 76 52 65 EE 5E 2B AB D8 F7 BC 9F D1 21 64 50 2C 42 C4 A3 51 47 7A 08 1E 19 BE 41 66 B0 1B 15 F7 65 5C 1C DC 3B 2F BE 37 F2 77 C2 A9 CA F6 93 73 66 1A 2E 16 03 28 84 CB A3 FA E5 FE 71 4C 07 32 54 61 20 D5 03 26 EF B7 38 ED 8E 36 38 43 6A 9A 05 1A DE 68 3A FB E9 A3 16 24 17 27 8F 39 61 49 63 DF 34 74 AB DE 3B 6F 3F FA 4E EC 50 D2 16 D4 5E CC 0A C3 07 F9 31 5A D6 AF E3 9F BD FA 98 8D 7F </pre>	<p>CVC (continued)</p>
---	------------------------

<pre> 1081: 30 82 05 42 30 82 03 2A A0 03 02 01 02 02 08 04 04 04 04 04 04 04 04 30 0D 06 09 2A 86 48 86 F7 0D 01 01 0B 05 00 30 6E 31 0B 30 09 06 03 55 04 06 13 02 55 53 31 12 30 10 06 03 55 04 0A 13 09 43 61 62 6C 65 4C 61 62 73 31 12 30 10 06 03 55 04 0B 13 09 52 6F 6F 74 20 43 41 30 31 31 37 30 35 06 03 55 04 03 13 2E 45 78 61 6D 70 6C 65 20 43 61 62 6C 65 4C 61 62 73 20 52 6F 6F 74 20 43 65 72 74 69 66 69 63 61 74 69 6F 6E 20 41 75 74 68 6F 72 69 74 79 30 1E 17 0D 31 34 30 39 31 37 31 38 31 38 34 37 5A 17 0D 34 39 30 39 31 37 31 38 31 38 34 37 5A 30 6C 31 0B 30 09 06 03 55 04 06 13 02 55 53 31 12 30 10 06 03 55 04 0A 13 09 43 61 62 6C 65 4C 61 62 73 31 11 30 0F 06 03 55 04 0B 13 08 43 56 43 20 43 41 30 31 31 36 30 34 06 03 55 04 03 13 2D 45 78 61 6D 70 6C 65 20 43 61 62 6C 65 4C 61 62 73 20 43 56 43 20 43 65 72 74 69 66 69 63 61 74 69 6F 6E 20 41 75 74 68 6F 72 69 74 79 30 82 01 A2 30 0D 06 09 2A 86 48 86 F7 0D 01 01 01 05 00 03 82 01 8F 00 30 82 01 8A 02 82 01 81 00 B8 16 AB 6B 57 91 22 86 79 DF D9 8E 90 EC 04 A2 4D 5C A4 0B 7E 87 61 17 D2 8B 1A CF B3 D9 5B 7B B1 2A C8 57 90 2E F6 50 91 68 F9 42 18 94 90 C3 56 55 BC 80 39 D5 02 7D 29 CC E3 70 C1 F0 7F CD A0 09 8E 5C A3 AE DC 92 E7 32 8C 80 17 0E 33 B4 55 40 1F </pre>	<pre> CableLabs DOCSIS CVC CA Certificate (Required for all code files) Binary (DER) format CVC CA Begins at offset 1330 (0x532) CVC CA Ends at offset 2769 (0xAD1) CVC CA Length 1440 (0x5A0) See Table III-1 for details of CVC CA. </pre>
--	--

<pre> 87 9A 43 F1 B0 2F 07 6B F1 A6 BB 8B 51 E2 7A 9C 10 54 AC DC DA CE DB CC 89 5F 91 C6 57 7E 66 52 AC 77 8F 0D E6 29 3D 0D E5 F2 02 4A 88 AB 38 EB A4 8E 12 60 FC AC F2 A2 E5 70 F3 F8 31 CB BF BF FB 28 9A 56 4D C2 AF 6D A5 26 CA 3A DC 33 78 A7 D2 49 94 B8 84 F8 A2 AB BD AD 0B 32 5A 4B 1A 6F 61 FA 60 50 26 06 5D 5F 47 53 3A 50 73 A9 73 EE D1 8E 17 47 3A 1A 9B 0D C9 55 07 86 28 4F 8C BE 3E E0 19 98 66 07 F7 CD 20 F6 F5 2E 65 59 23 A8 EB 66 51 CA 15 1B 47 E3 5C 9B CB 62 C0 44 36 11 EC CF 14 7F 49 70 1B B6 B7 45 4D C4 99 B5 8E 78 DC 2D 70 4C FA 96 00 06 D2 38 00 35 8F AB 03 89 3B C4 66 FD EE 9E AD 30 F6 D2 CB 91 50 42 AE A0 54 61 C5 B9 02 4E EB 0C 00 E3 20 97 E5 80 F3 48 92 BB 30 DC 38 B9 18 19 05 C0 54 FB 0A A0 9F 4F 55 EB B9 22 CD 50 FC 96 8E 96 4A 91 00 67 19 3B 72 C0 31 62 23 05 EE 90 44 A1 40 3A 58 1D 17 65 7E 7E F7 2D C9 C6 E3 51 C4 F0 59 5B B2 48 31 FB CA 76 BA 6F 81 CE 9F 77 8A EB B7 A8 AD 02 03 01 00 01 A3 66 30 64 30 0E 06 03 55 1D 0F 01 01 FF 04 04 03 02 01 06 30 12 06 03 55 1D 13 01 01 FF 04 08 30 06 01 01 FF 02 01 00 30 1D 06 03 55 1D 0E 04 16 04 14 BA 30 B0 DF 3A 7F 34 62 7C B7 A6 95 A3 0F 81 00 32 01 CC B0 30 1F 06 03 55 1D 23 04 18 30 16 80 14 1F 43 E6 00 FC 16 2E 5A EA A5 4E 78 6F 04 64 E1 AE E6 </pre>	<p>CVC CA (continued)</p>
--	---------------------------

A4 A8 30 0D 06 09 2A 86	CVC CA (continued)
48 86 F7 0D 01 01 0B 05	
00 03 82 02 01 00 AC B2	
7F 24 E6 B4 07 88 3F 6B	
ED 70 DA 05 AA 04 9C 62	
F1 39 09 2B 3A BD DF 23	
63 27 59 BB 01 40 81 72	
F5 84 C2 79 C1 26 0B 14	
F5 73 AA 21 BA 08 D1 8D	
2C 59 7F E0 DC 7E 90 86	
D0 11 45 BF F5 AB 26 21	
0C F0 89 37 BD 51 AD 94	
0C 90 10 E8 4B 7C C3 6E	
C7 41 03 13 43 F2 56 3E	
1B 27 ED 86 15 9D 3A 03	
72 ED 4B F0 6E 61 BD AD	
D1 09 00 04 66 83 8F C5	
A2 C6 B7 F3 69 BF CA 5E	
E6 CA 56 70 21 25 10 1D	
A4 D9 6B BA 5F DD A1 49	
53 E1 E2 4D CF 9D EF 44	
5A 19 D6 B7 AB 74 E7 88	
D6 6F 37 EB E0 2E F3 0C	
C5 FA 44 D9 2E F0 65 23	
ED 67 2D A5 E9 D0 14 22	
97 F6 84 CE 88 8F A3 71	
1A CD 64 88 D9 F7 4B 61	
83 FA 8D 20 12 01 A6 2B	
13 34 2C 30 BD DD 0A 28	
79 F1 C9 6A 34 4B 9B 50	
22 A4 6A 12 B6 E0 CC 87	
8F 35 46 FA E5 29 C8 E7	
1A 2F 38 65 48 8D 20 E3	
B2 86 23 AA 40 2B 76 93	
9D 24 22 3D 6A A6 81 CE	
12 4C FC 1A 03 49 21 33	
33 C7 21 04 A2 20 FD D1	
D4 C8 80 C3 58 A4 06 86	
43 7B 65 3A 73 E5 B2 00	
76 A2 20 4A FD 2C F5 97	
45 67 D6 B4 52 49 93 A5	
73 99 BB 49 86 B2 1A A0	
6C 15 98 49 35 03 4A 66	
75 ED B0 95 30 9C 67 7E	
50 81 9D 0E B1 3F F2 A1	
1B 7F 84 1E 95 86 52 99	
69 70 8E B0 88 79 17 83	
33 14 AD 29 72 4E 6E B4	
C0 B9 5F D8 CD ED E1 CE	
41 4A 49 BE 52 6E F1 6C	
3D 21 02 47 49 9E B4 D6	

<pre> 48 8C 8D 2D 5B CA B8 FC 03 DC D2 04 7A 50 01 37 AC FA EF 4B BE 14 62 60 D4 B5 1D 52 CB EB 64 BE 33 2A 5A 0E 04 D2 71 68 9D 6E 77 89 B6 62 A4 84 39 10 A6 8C F1 2D 9C 89 9E C1 4B 41 F6 D7 B9 28 61 AB 93 55 3B 4E 24 57 51 83 C5 FD BE 37 DD 4D D9 EA 7E 35 63 8B 3A 95 67 AA 2F C8 4E ED 81 22 B7 87 84 E6 80 0E 11 2D 61 4A F0 99 F6 A4 C9 5F F6 BA 1D 49 12 CF 5A 3A 77 4A 9A FA 1B 30 </pre>	<p>CVC CA (continued)</p>
<p>2431: 31 82 02 0E</p>	<p>SET OF SignerInfo header Note: This field length includes the size(s) of all enclosed SignerInfo structures. If both Manufacturer and Co-signer SignerInfo structures are present, then this size is the total size of the Manufacturer SignerInfo plus the total size of the Co-signer SignerInfo.</p>
<p>2435: 30 82 02 0A</p>	<p>Manufacturer SignerInfo header</p>
<p>2439 02 01 01</p>	<p>Version=1</p>
<p>2442: 30 78</p>	<p>IssuerAndSerialNumber header</p>
<p>2444: 30 6C</p>	<p>Issuer Name header</p>
<pre> 2446: 31 0B 2448: 30 09 2450: 06 03 55 04 06 2455: 13 02 55 53 </pre>	<p>AttributeType=countryName AttributeValue="US"</p>
<pre> 2459: 31 12 2461: 30 10 2463: 06 03 55 04 0A 2468: 13 09 43 61 62 6C 65 4C 61 62 73 </pre>	<p>AttributeType=organizationalName AttributeValue="CableLabs"</p>
<pre> 2479: 31 11 2481: 30 0F 2483: 06 03 55 04 0B 2488: 13 08 43 56 43 20 43 41 30 31 </pre>	<p>AttributeType = organizationalUnitName AttributeValue = "CVC CA01"</p>
<pre> 2498: 31 36 2500: 30 34 2502: 06 03 55 04 03 2507: 13 2D 45 78 61 6D 70 6C 65 20 43 61 62 6C 65 4C 61 62 73 20 43 56 43 20 43 65 72 74 69 66 69 63 61 74 69 6F 6E 20 41 75 74 68 6F 72 69 74 79 </pre>	<p>AttributeType=commonName AttributeValue= "Example CableLabs CVC Certification Authority"</p>

2554: 02 08 05 05 05 05 05 05 05 05	CertificateSerialNumber = 05 05 05 05 05 05 05 05
2564: 30 0D 2566: 06 09 60 86 48 01 65 03 04 02 01 2577: 05 00	DigestAlgorithmIdentifier header Algorithm=SHA-256 (OID: 2 16 840 1 101 3 4 2 1) Parameters=NULL
2579: A0 69	[0] AuthenticateAttributes
2581: 30 18 2583: 06 09 2A 86 48 86 F7 0D 01 09 03 2594: 31 0B 2596: 06 09 2A 86 48 86 F7 0D 01 07 01	ContentType header AttributeType=contentType (OID: 1 2 840 113549 1 9 3) SET OF AttributeValue=Data (OID: 1 2 840 113549 1 7 1)
2607: 30 1C 2609: 06 09 2A 86 48 86 F7 0D 01 09 05 2620: 31 0F 2622: 17 0D 31 34 30 39 31 37 30 30 30 30 30 30 5A	SigningTime header AttributeType= signingTime (pkcs-9 signingTime OID: 1 2 840 113549 1 9 5) SET OF attributeValue=2014/09/17/00:00:00Z GMT
2637: 30 2F 2639: 06 09 2A 86 48 86 F7 0D 01 09 04 2650: 31 22 2652: 04 20 C4 4E 77 9C B8 9C 12 AF 40 36 A8 CA E5 BF 27 C5 85 09 38 00 86 FB 07 A5 54 39 21 AA 2E 03 E4 B9	MessageDigest header AttributeType=messageDigest SET OF attributeValue=OCTET STRING Message Digest
2686: 30 0D 2688: 06 09 2A 86 48 86 F7 0D 01 01 01 2699: 05 00	DigestEncryptionAlgorithm header Algorithm=RSA Encryption (OID: 1 2 840 113549 1 1 1) Parameters=NULL

2701: 04 82 01 00 A0 3F DC 85 B7 FD 38 D0 FF 82 32 B8 E5 1E 15 48 FB DE E0 F2 15 7C 8F B1 2F EB 18 71 EF 51 AD B7 58 08 EE 73 2D 2B F5 8D 08 44 F7 A0 9A 06 80 23 27 D7 5C C2 59 60 EC F0 D4 41 82 CA 83 9A F8 3A 61 6B 42 B6 79 51 CF 08 2B 13 AA DF 26 08 1F 43 17 18 71 7E 52 13 0C 6F 14 88 F0 75 89 2A AB B7 52 2B 04 70 AC D9 F1 6B 2E ED 7F 27 79 28 E4 7C 93 00 4D 45 90 88 1A 05 71 09 12 EF F0 82 AA C0 74 C1 7C 6F AE D0 98 50 75 FA 72 1E 0D 28 D5 5A 87 3E 49 95 57 91 07 01 07 0A B8 51 EE 5D 6C 54 39 C6 D6 12 A0 75 57 FC C0 50 E6 8D 91 BB F8 5E 35 C7 5C 59 0B DA 84 5F EA 7C F5 74 7A 9D BE 04 C4 2B CE 8A FD B3 86 2C 23 B0 1B D1 A8 0D 0E 8E A6 08 BA D9 A8 65 24 0D 14 69 C8 0D 04 4A 79 04 28 A5 23 77 F6 B1 1C 3B 17 8D 15 77 38 99 EC 7E 6C 03 A3 DD D8 4B FD CA 80 12 3C 1A 32 BD E8 B8	OCTET STRING EncryptedDigest
	End MfgSignerInfo
	End signer info
	End signed data
	End [PKCS#7] Digital Signature
	SignedContent{
2961: 1C 00 00	
	} End of Download Parameters
2964: 48 65 6C 6C 6F 20 57 6F 72 6C 64 0A	CodeImage() { "Hello World\n" }
	Notes: Vendor-specific formatting
	} End of SignedContent

Table I-2 - CVC Example

	X509 Certificate {
0000: 30 82 03 F9	CVC header
0004: 30 82 02 61	tbs CVC header
0008: A0 03	Version=v3
0010: 02 01 02	
0013: 02 08	Serial Number =
0015: 05 05 05 05 05 05 05 05	05 05 05 05 05 05 05 05
0023: 30 0D	Signature Algorithm=
0025: 06 09 2A 86 48 86 F7 0D 01 01 0B	SHA-256 with RSA Encryption
0036: 05 00	(OID: 1 2 840 113549 1 1 11)
	Parameters = NULL
0038: 30 6C	Issuer SEQUENCE

0040: 31 0B 0042: 30 09 0044: 06 03 55 04 06 0049: 13 02 55 53	AttributeType= countryName (OID: 2 5 4 6) AttributeValue="US"
0053: 31 12 0055: 30 10 0057: 06 03 55 04 0A 0062: 13 09 43 61 62 6C 65 4C 61 62 73	AttributeType= organizationalName (OID: 2 5 4 10) AttributeValue="CableLabs"
0073: 31 11 0075: 30 0F 0077: 06 03 55 04 0B 0082: 13 08 43 56 43 20 43 41 30 31	AttributeType= organizationalUnitName (OID: 2 5 4 11) AttributeValue="CVC CA01"
0092: 31 36 0094: 30 34 0096: 06 03 55 04 03 0101: 13 2D 45 78 61 6D 70 6C 65 20 43 61 62 6C 65 4C 61 62 73 20 43 56 43 20 43 65 72 74 69 66 69 63 61 74 69 6F 6E 20 41 75 74 68 6F 72 69 74 79	AttributeType= commonName (OID: 2 5 4 3) AttributeValue="Example CableLabs CVC Certification Authority"
0148: 30 1E 0150: 17 0D 0152: 31 34 30 39 31 37 31 38 32 31 35 34 5A 0165: 17 0D 32 34 30 39 31 37 31 38 32 31 35 34 5A	Validity SEQUENCE Not before=2014/09/17 18:21:54 GMT Not after=2024/09/17 18:21:54 GMT (10 Years)
0180: 30 50	Subject SEQUENCE
0182: 31 0B 0184: 30 09 0186: 06 03 55 04 06 0191: 13 02 55 53	AttributeType=countryName (OID: 2 5 4 6) AttributeValue="US"
0195: 31 11 0197: 30 0F 0199: 06 03 55 04 0A 0204: 13 08 42 72 6F 61 64 63 6F 6D	AttributeType= organizationalName (OID: 2 5 4 10) AttributeValue="Broadcom"
0214: 31 2E 0216: 30 2C 0218: 06 03 55 04 03 0223: 13 25 45 78 61 6D 70 6C 65 20 43 6F 64 65 20 56 65 72 69 66 69 63 61 74 69 6F 6E 20 43 65 72 74 69 66 69 63 61 74 65	AttributeType=commonName (OID: 2 5 4 3) AttributeValue="Code Verification Certificate"
0262: 30 82 01 22	SubjectPublicKeyInfo header
0266: 30 0D 0268: 06 09 2A 86 48 86 F7 0D 01 01 01 0279: 05 00	Public Key SEQUENCE Algorithm=RSA encryption (OID: 1 2 840 113549 1 1 1) Parameters=NULL

0281: 03 82 01 0F 00	Public Key header
0286: 30 82 01 0A	Public Key modulus header
0290: 02 82 01 01 00 0295: E1 E7 F2 0A B4 B1 B6 A7 DD 0E 8E A7 6E DF B2 56 63 F4 6B 9C E9 40 D9 85 2B 5A 7B 98 4B F6 89 FE A8 39 7A FD F8 B8 D8 40 F0 C8 7E 0B 6F 9B 43 CD 28 99 7D 53 32 CD 6F D5 15 DD 2B ED 2D 4B B9 8F 05 A7 B6 C5 53 63 79 9B 76 8B 8F 9E DF 42 59 28 16 1B A8 EF BF 0C 36 28 3D 56 C4 FF 73 4B 56 6A 3A CE 27 36 12 33 B0 79 E5 13 6E 36 68 11 07 8D E3 99 69 22 F4 54 7C A2 CE 5A E2 38 73 2E 79 0E 17 AE 86 57 01 27 2E 50 13 BD 54 E5 36 4E 71 40 82 40 CB 8D 3B 03 92 5E 06 3F 20 DB 73 58 A3 72 3F 8F B8 F5 A5 D9 0D 22 99 DA 89 DC 2B A3 F4 6C 53 DD B2 06 73 CA 22 14 08 59 19 05 D6 92 49 56 5C 60 1D 9F 35 D2 53 DB E2 81 0D 94 B2 16 3B F1 AF 04 48 9C 41 54 07 43 18 65 DA C3 A2 A8 6C 2A A1 8D 16 51 55 16 EA 14 3C 5C B0 2F 8F 0A F9 4E 3E 7E 12 42 4B DD 7D 25 06 B6 0E 99 1E 7F 16 33	INTEGER Public Key modulus (Keysize=2048-bits)
0551: 02 03 01 00 01	INTEGER Public Key exponent=65537
0056: A3 3B 0058: 30 39 0560: 30 16 0562: 06 03 55 1D 25 0567: 01 01 FF 0570: 04 0C 0572: 30 0A 0574: 06 08 2B 06 01 05 05 07 03 03	[3] Extensions Extensions header SEQUENCE Extension header SEQUENCE Extended Key Usage (OID: 2 5 29 37) Critical=TRUE keyPurposeID=codeSigning (OID: 1 3 6 1 5 5 7 3 3)
0584: 30 1F 0586: 06 03 55 1D 23 0591: 04 18 0593: 30 16 0595: 80 14 BA 30 B0 DF 3A 7F 34 62 7C B7 A6 95 A3 0F 81 00 32 01 CC B0	Signature SEQUENCE Algorithm=SHA-1 with RSA (OID: 2 5 29 35) Parameters=NULL keyid: BA:30:B0:DF:3A:7F:34:62: 7C:B7:A6:95:A3:0F:81:00: 32:01:CC:B0
0632: 03 82 01 81 00	Signature value header

0637: 3F D3 6A F3 4B EA 89 02 C8 27 9C 43 AE 55 AF E5 7A A2 23 03 4A 29 69 78 D5 4D 4B AA E8 B2 7E 42 99 66 BC C9 82 A3 ED D2 F0 7F 77 22 E8 D7 C5 AD A0 58 DB 43 DA 6D 4B D6 1D 6E 73 38 0D 60 30 C0 9A 5F 22 62 7C BA F1 CE 44 B4 71 E6 72 D0 19 B5 5E 39 46 A9 13 00 18 7F 43 7A ED 31 A3 E5 7C FD 8B EE 4D AC 0D 46 09 59 BB 8C 6B A9 DA 44 62 35 65 4D 34 3E 41 A5 52 FE D2 A9 A2 FC 19 DF F3 70 9E 92 CD C2 24 32 BB 8A 58 45 12 17 B6 E2 AF 19 2D F5 3C 60 31 2F 71 87 F4 CA EC 7F C9 4B F4 3C 18 30 C5 B0 CF CC 45 EB C2 82 D9 3A 6D DD A4 8D E4 CD 7D 50 AA 7B FA 54 6A 36 D1 48 39 D7 D5 B2 AE 75 7D 76 DC F7 88 A5 F4 D6 C0 2D AD D6 80 5B 32 EC EA 47 20 44 A9 60 87 C4 8F 16 3F FC 83 48 B2 39 E8 46 FD 0A 91 AC C0 DC C7 7A 92 00 E0 58 0C CA 96 EB E0 BC 0F FA 9F 6A 19 D3 9E 0F 23 76 52 65 EE 5E 2B AB D8 F7 BC 9F D1 21 64 50 2C 42 C4 A3 51 47 7A 08 1E 19 BE 41 66 B0 1B 15 F7 65 5C 1C DC 3B 2F BE 37 F2 77 C2 A9 CA F6 93 73 66 1A 2E 16 03 28 84 CB A3 FA E5 FE 71 4C 07 32 54 61 20 D5 03 26 EF B7 38 ED 8E 36 38 43 6A 9A 05 1A DE 68 3A FB E9 A3 16 24 17 27 8F 39 61 49 63 DF 34 74 AB DE 3B 6F 3F FA 4E EC 50 D2 16 D4 5E CC 0A C3 07 F9 31 5A D6 AF E3 9F BD FA 98 8D 7F	Signature value
--	-----------------

Table I-3 - CVC-CA Example

	X509 Certificate {
0000: 30 82 05 42	CVC header
0004: 30 82 03 2A	tbs CVC header
0008: A0 03 0010: 02 01 02	Version=v3
0013: 02 08 04 04 04 04 04 04 04 04	Serial Number = 05 05 05 05 05 05 05 05
0023: 30 0D 0025: 06 09 2A 86 48 86 F7 0D 01 01 0B 0036: 05 00	Signature Algorithm=SHA-256 with RSA Encryption (OID: 1 2 840 113549 1 1 11) Parameters = NULL
0038: 30 6E	Issuer SEQUENCE
0040: 31 0B 0042: 30 09 0044: 06 03 55 04 06 0049: 13 02 55 53	AttributeType=countryName (OID: 2 5 4 6) AttributeValue="US"
0053: 31 12 0055: 30 10 0057: 06 03 55 04 0A 0062: 13 09 43 61 62 6C 65 4C 61 62 73	AttributeType= organizationalName (OID: 2 5 4 10) AttributeValue="CableLabs"
0073: 31 12 0075: 30 10 0077: 06 03 55 04 0B 0082: 13 09 52 6F 6F 74 20 43 41 30 31	AttributeType= organizationalUnitName (OID: 2 5 4 11) AttributeValue="Root CA01"

0093: 31 37 0095: 30 35 0097: 06 03 55 04 03 0102: 13 2E 45 78 61 6D 70 6C 65 20 43 61 62 6C 65 4C 61 62 73 20 52 6F 6F 74 20 43 65 72 74 69 66 69 63 61 74 69 6F 6E 20 41 75 74 68 6F 72 69 74 79	AttributeType=commonName (OID: 2 5 4 3) AttributeValue="Example CableLabs Root Certification Authority"
0150: 30 1E 0152: 17 0D 31 34 30 39 31 37 31 38 31 38 34 37 5A 0167: 17 0D 34 39 30 39 31 37 31 38 31 38 34 37 5A	Validity SEQUENCE Not before= 2014/09/17 18:18:47 GMT Not after= 2049/09/17 18:18:47 GMT (35 Years)
0182: 30 6C	Subject SEQUENCE
0184: 31 0B 0186: 30 09 0188: 06 03 55 04 06 0193: 13 02 55 53	AttributeType=countryName (OID: 2 5 4 6) AttributeValue="US"
0197: 31 12 0199: 30 10 0201: 06 03 55 04 0A 0206: 13 09 43 61 62 6C 65 4C 61 62 73	AttributeType= organizationalName (OID: 2 5 4 10) AttributeValue="CableLabs"
0217: 31 11 0219: 30 0F 0221: 06 03 55 04 0B 0226: 13 08 43 56 43 20 43 41 30 31	AttributeType= organizationalName (OID: 2 5 4 11) AttributeValue="CVC CA01"
0236: 31 36 0238: 30 34 0240: 06 03 55 04 03 0245: 13 2D 45 78 61 6D 70 6C 65 20 43 61 62 6C 65 4C 61 62 73 20 43 56 43 20 43 65 72 74 69 66 69 63 61 74 69 6F 6E 20 41 75 74 68 6F 72 69 74 79	AttributeType=commonName (OID: 2 5 4 3) AttributeValue= "CableLabs CVC Certification Authority"
0292: 30 82 01 A2	SubjectPublicKeyInfo header
0296: 30 0D 0298: 06 09 2A 86 48 86 F7 0D 01 01 01 0309: 05 00	Public Key SEQUENCE Algorithm= RSA encryption (OID: 1 2 840 113549 1 1 1) Parameters=NULL
0311: 03 82 01 8F 00	Public Key header
0316: 30 82 01 8A	Public Key modulus header

0320: 02 82 01 81 00	INTEGER
0325: B8 16 AB 6B 57 91 22 86 79 DF D9 8E 90 EC 04 A2 4D 5C A4 0B 7E 87 61 17 D2 8B 1A CF B3 D9 5B 7B B1 2A C8 57 90 2E F6 50 91 68 F9 42 18 94 90 C3 56 55 BC 80 39 D5 02 7D 29 CC E3 70 C1 F0 7F CD A0 09 8E 5C A3 AE DC 92 E7 32 8C 80 17 0E 33 B4 55 40 1F 87 9A 43 F1 B0 2F 07 6B F1 A6 BB 8B 51 E2 7A 9C 10 54 AC DC DA CE DB CC 89 5F 91 C6 57 7E 66 52 AC 77 8F 0D E6 29 3D 0D E5 F2 02 4A 88 AB 38 EB A4 8E 12 60 FC AC F2 A2 E5 70 F3 F8 31 CB BF BF FB 28 9A 56 4D C2 AF 6D A5 26 CA 3A DC 33 78 A7 D2 49 94 B8 84 F8 A2 AB BD AD 0B 32 5A 4B 1A 6F 61 FA 60 50 26 06 5D 5F 47 53 3A 50 73 A9 73 EE D1 8E 17 47 3A 1A 9B 0D C9 55 07 86 28 4F 8C BE 3E E0 19 98 66 07 F7 CD 20 F6 F5 2E 65 59 23 A8 EB 66 51 CA 15 1B 47 E3 5C 9B CB 62 C0 44 36 11 EC CF 14 7F 49 70 1B B6 B7 45 4D C4 99 B5 8E 78 DC 2D 70 4C FA 96 00 06 D2 38 00 35 8F AB 03 89 3B C4 66 FD EE 9E AD 30 F6 D2 CB 91 50 42 AE A0 54 61 C5 B9 02 4E EB 0C 00 E3 20 97 E5 80 F3 48 92 BB 30 DC 38 B9 18 19 05 C0 54 FB 0A A0 9F 4F 55 EB B9 22 CD 50 FC 96 8E 96 4A 91 00 67 19 3B 72 C0 31 62 23 05 EE 90 44 A1 40 3A 58 1D 17 65 7E 7E F7 2D C9 C6 E3 51 C4 F0 59 5B B2 48 31 FB CA 76 BA 6F 81 CE 9F 77 8A EB B7 A8 AD	Public Key modulus (Keysize=3072-bits)
0551: 02 03 0553: 01 00 01	INTEGER Public Key exponent=65537
0714: A3 66 0716: 30 64 0718: 30 0E 0720: 06 03 55 1D 0F 0725: 01 01 FF 0728: 04 04 0730: 03 02 01 06	[3] X509v3 Extensions Extensions header SEQUENCE Extension header SEQUENCE Key Usage (OID: 2 5 29 15) Critical=TRUE Certificate Sign CRL Sign
0734: 30 12 0736: 06 03 55 1D 13 0741: 01 01 FF 0744: 04 08 0746: 30 06 0748: 01 01 FF 0751: 02 01 00	Signature SEQUENCE basicConstraints (OID: 2 5 29 19) CA:TRUE pathlen:0
0754: 30 1D 0756: 06 03 55 1D 0E 0761: 04 16 0763: 04 14 BA 30 B0 DF 3A 7F 34 62 7C B7 A6 95 A3 0F 81 00 32 01 CC B0	subjectKeyIdentifier (OID: 2 5 29 14) BA:30:B0:DF:3A:7F:34:62: 7C:B7:A6:95:A3:0F:81:00: 32:01:CC:B0
0785: 30 1F 0787: 06 03 55 1D 23 0792: 04 18 0794: 30 16 0796: 80 14 1F 43 E6 00 FC 16 2E 5A EA A5 4E 78 6F 04 64 E1 AE E6 A4 A8	authorityKeyIdentifier (OID: 2 5 29 35) keyid: 1F:43:E6:00:FC:16:2E:5A: EA:A5:4E:78:6F:04:64:E1: AE:E6:A4:A8

<pre>0818: 30 0D 0820: 06 09 2A 86 48 86 F7 0D 01 01 0B 0831: 05 00</pre>	SHA-256 with RSA Encryption (OID: 1 2 840 113549 1 1 11)
<pre>0833: 03 82 02 01 00</pre>	Signature value header
<pre>0838: AC B2 7F 24 E6 B4 07 88 3F 6B ED 70 DA 05 AA 04 9C 62 F1 39 09 2B 3A BD DF 23 63 27 59 BB 01 40 81 72 F5 84 C2 79 C1 26 0B 14 F5 73 AA 21 BA 08 D1 8D 2C 59 7F E0 DC 7E 90 86 D0 11 45 BF F5 AB 26 21 0C F0 89 37 BD 51 AD 94 0C 90 10 E8 4B 7C C3 6E C7 41 03 13 43 F2 56 3E 1B 27 ED 86 15 9D 3A 03 72 ED 4B F0 6E 61 BD AD D1 09 00 04 66 83 8F C5 A2 C6 B7 F3 69 BF CA 5E E6 CA 56 70 21 25 10 1D A4 D9 6B BA 5F DD A1 49 53 E1 E2 4D CF 9D EF 44 5A 19 D6 B7 AB 74 E7 88 D6 6F 37 EB E0 2E F3 0C C5 FA 44 D9 2E F0 65 23 ED 67 2D A5 E9 D0 14 22 97 F6 84 CE 88 8F A3 71 1A CD 64 88 D9 F7 4B 61 83 FA 8D 20 12 01 A6 2B 13 34 2C 30 BD DD 0A 28 79 F1 C9 6A 34 4B 9B 50 22 A4 6A 12 B6 E0 CC 87 8F 35 46 FA E5 29 C8 E7 1A 2F 38 65 48 8D 20 E3 B2 86 23 AA 40 2B 76 93 9D 24 22 3D 6A A6 81 CE 12 4C FC 1A 03 49 21 33 33 C7 21 04 A2 20 FD D1 D4 C8 80 C3 58 A4 06 86 43 7B 65 3A 73 E5 B2 00 76 A2 20 4A FD 2C F5 97 45 67 D6 B4 52 49 93 A5 73 99 BB 49 86 B2 1A A0 6C 15 98 49 35 03 4A 66 75 ED B0 95 30 9C 67 7E 50 81 9D 0E B1 3F F2 A1 1B 7F 84 1E 95 86 52 99 69 70 8E B0 88 79 17 83 33 14 AD 29 72 4E 6E B4 C0 B9 5F D8 CD ED E1 CE 41 4A 49 BE 52 6E F1 6C 3D 21 02 47 49 9E B4 D6 48 8C 8D 2D 5B CA B8 FC 03 DC D2 04 7A 50 01 37 AC FA EF 4B BE 14 62 60 D4 B5 1D 52 CB EB 64 BE 33 2A 5A 0E 04 D2 71 68 9D 6E 77 89 B6 62 A4 84 39 10 A6 8C F1 2D 9C 89 9E C1 4B 41 F6 D7 B9 28 61 AB 93 55 3B 4E 24 57 51 83 C5 FD BE 37 DD 4D D9 EA 7E 35 63 8B 3A 95 67 AA 2F C8 4E ED 81 22 B7 87 84 E6 80 0E 11 2D 61 4A F0 99 F6 A4 C9 5F F6 BA 1D 49 12 CF 5A 3A 77 4A 9A FA 1B 30</pre>	Signature value

Appendix II Example of Multilinear Modular Hash (MMH) Algorithm Implementation (Informative)

This appendix gives an example implementation of the MMH MAC algorithm defined in Section 11.7.2. There may be other implementations that have advantages over this example in particular operating environments. This example is for informational purposes only and does not completely follow the DOCSIS MMH MAC algorithm defined in Section 11.7.3.

A main program is included for exercising the example implementation. The output produced by the program is included.

```
// Example code for MMH algorithm as defined in the DOCSIS 3.0 security specification
// Based on code in PacketCable security specification
// Original code by Mike Sabin
// DOCSIS modifications by Doc Evans, N7DR@arrisi.com
// This code is far from optimal; it is intended to be easy to follow, not fast to
execute

// Written for gcc 3.3.6

#include <iomanip>
#include <iostream>
#include <string>

#include <inttypes.h>
#include <stdio.h>

// Define this symbol to see intermediate values.
#define VERBOSE

// Define this symbol if you want to duplicate the PacketCable test vectors
#undef PACKETCABLE

// save ourselves some typing
using namespace std;

// Routine to reduce an int32_t value modulo F4, where F4 = 0x10001.
// Result is therefore in range [0, 0x10000].
const int32_t reduceModF4(const int32_t x)
{ int32_t rv = x; // holder for return value

// If x is negative, add a multiple of F4 to make it non-negative.
// This loop executes no more than twice.
while (rv < 0)
    rv += 0x7fff7fff;

// Subtract high 16 bits of rv from low 16 bits.
const int32_t xHi = rv >> 16;
const int32_t xLo = rv & 0xffff;
rv = xLo - xHi;

// If x is negative, add F4.
if (rv < 0)
    rv += 0x10001;

// we are done
return rv;
}
```

```

/*
Compute and return the MMH16 MAC of the message using the
indicated key and one-time pad.
The length of the key is to be at least msgLen bytes.
The length of the pad is at least two bytes.
*/
const uint16_t mmh16(const string& message,
                    const string& key,
                    const string& pad)
{
// check lengths
if (key.length() < message.length())
    throw exception();

if (pad.length() < 2)
    throw exception();

// ok to proceed
int32_t sum = 0;          // 32-bit accumulator

for (unsigned int i = 0; i < message.length(); i += 2)
{
// Build a 16-bit factor from the next two message octets
const int16_t x = (static_cast<uint16_t>(static_cast<unsigned char>(message[i])
<< 8)
                |
                static_cast<uint16_t>(static_cast<unsigned char>(message[i +
1])));

// Build a 16-bit factor from the next two key octets
const int16_t y = (static_cast<uint16_t>(static_cast<unsigned char>(key[i])) <<
8) |
                static_cast<uint16_t>(static_cast<unsigned char>(key[i + 1])));

// Accumulate product of the factors into 32-bit sum
sum += (static_cast<int32_t>(x) * static_cast<int32_t>(y));

#ifdef VERBOSE
    cout << hex << " x 0x" << setw(2) << x
         << " y 0x" << setw(2) << y
         << " sum 0x" << setw(2) << sum << dec << endl;
#endif // VERBOSE
}

// Reduce sum modulo F4 and truncate to 16 bits
uint16_t u = static_cast<uint16_t>(reduceModF4(sum));

#ifdef VERBOSE
    cout << hex << " sum mod F4, truncated to 16 bits: 0x" << setw(2) << u << dec <<
endl;
#endif // VERBOSE

// Build the pad variable from the two pad bytes
const uint16_t v = (static_cast<uint16_t>(static_cast<unsigned char>(pad[0])) << 8)
|
                static_cast<uint16_t>(static_cast<unsigned char>(pad[1])));

#ifdef VERBOSE
    cout << hex << " pad variable: 0x" << setw(2) << v << dec << endl;
#endif // VERBOSE

/* Accumulate pad variable, truncate to 16 bits */
u = static_cast<uint16_t>(u + v);

```

```

#if defined(VERBOSE)
    cout << hex << " mmh16 value: 0x" << setw(2) << u << dec << endl;
#endif
    // VERBOSE
    return u;
}

/*
Compute and return the MMH32 MAC of the message using the
indicated key and pad.
The length of the message is msgLen bytes; msgLen is to be even.
The length of the key is to be at least (msgLen + 2) bytes.
The length of the pad is four bytes. The pad is to be freshly
picked from a secure random source.
*/
const uint32_t mmh32(const string& message,
                    const string& key,
                    const string& pad)
{
    // check lengths
    if (key.length() < (message.length() + 2))
        throw exception();

    if (pad.length() < 4)
        throw exception();

    const uint16_t x = mmh16(message, key, pad);
    const uint16_t y = mmh16(message, key.substr(2), pad.substr(2));
    const uint32_t sum = (static_cast<const uint32_t>(x) << 16) |
        static_cast<const uint32_t>(y);

    return sum;
}

/*
Compute and return the MMH64 MAC of the message using the
indicated key and pad.
The length of the message is msgLen bytes; msgLen is to be even.
The length of the key is to be at least (msgLen + 6) bytes.
The length of the pad is eight bytes. The pad is to be freshly
picked from a secure random source.
*/
const uint64_t mmh64(const string& message,
                    const string& key,
                    const string& pad)
{
    // check lengths
    if (key.length() < (message.length() + 6))
        throw exception();

    if (pad.length() < 8)
        throw exception();

    const uint16_t a = mmh16(message, key, pad);
    const uint16_t b = mmh16(message, key.substr(2), pad.substr(2));
    const uint16_t c = mmh16(message, key.substr(4), pad.substr(4));
    const uint16_t d = mmh16(message, key.substr(6), pad.substr(6));

    const uint64_t sum = (((((static_cast<const uint64_t>(a) << 16) |
        static_cast<const uint64_t>(b)) << 16) |
        static_cast<const uint64_t>(c)) << 16) |
        static_cast<const uint64_t>(d));
}

```

```

    return sum;
}

/*
Routine to display a byte array
*/
template<class T>
void show(const string& rubric, const T& src, const unsigned int len)
{ const unsigned int BYTES_PER_LINE = 16;

  cout << rubric;

  for (unsigned int i = 0; i < len; i++)
  { if ((i % BYTES_PER_LINE) == 0)
    cout << endl;

    cout << setw(2) << hex << (unsigned int)(unsigned char)(src[i]) << " ";
  }

  cout << endl;
}

// helper function for displaying results
template<class T>
const string output_octets(const T& src)
{ string rv;
  const unsigned char* cp = (const unsigned char*)&src;

  for (int n = sizeof(src) - 1; n >= 0; n--)
    rv += cp[n];

  return rv;
}

// example of use
int main(void)
{
// set formatting for cout
  cout.fill('0');

  string key_;
  string pad_;

// define some test vectors

#if !defined(PACKETCABLE)
// a trivial keystream
  for (unsigned int key_nr = 0; key_nr < 100; key_nr++)
    key_ += char(key_nr);

// a similarly trivial one-time pad (that is much longer than we need);
  for (unsigned int pad_nr = 0; pad_nr < 100; pad_nr++)
    pad_ += char(pad_nr + 1);

// an historically interesting message that is to be hashed
  const string message_("The Magic Words are Squeamish Ossifrage");
#endif // !PACKETCABLE

#if defined(PACKETCABLE)
  const string message_("Now is the time.");

  unsigned char key[] = {
    0x35, 0x2c, 0xcf, 0x84, 0x95, 0xef, 0xd7, 0xdf, 0xb8,

```

```
    0xf5, 0x74, 0x05, 0x95, 0xeb, 0x98, 0xd6, 0xeb, 0x98,
};

unsigned char pad16[] = {
    0xae, 0x07,
};

unsigned char pad32[] = {
    0xbd, 0xe1, 0x89, 0x7b,
};

for (unsigned int key_nr = 0; key_nr < sizeof(key); key_nr++)
    key_ += key[key_nr];

for (unsigned int pad_nr = 0; pad_nr < sizeof(pad16); pad_nr++)
    pad_ += pad16[pad_nr];
#endif // PACKETCABLE

// MMH16
cout << "Example of MMH16 computation" << endl;

show("message", message_, message_.length());
show("key", key_, message_.length());
show("pad", pad_, 2);

const uint16_t mac16 = mmh16(message_, key_, pad_);

show("MMH16 MAC", output_octets(mac16), sizeof(mac16));
cout << endl;

#if defined(PACKETCABLE)
    pad_.clear();
    for (unsigned int apad_nr = 0; apad_nr < sizeof(pad32); apad_nr++)
        pad_ += pad32[apad_nr];
#endif // PACKETCABLE

// MMH32
cout << "Example of MMH32 computation" << endl;

show("message", message_, message_.length());
show("key", key_, message_.length() + 2);
show("pad", pad_, 4);

const uint32_t mac32 = mmh32(message_, key_, pad_);

show("MMH32 MAC", output_octets(mac32), sizeof(mac32));
cout << endl;

#if !defined(PACKETCABLE)
// MMH64
cout << "Example of MMH64 computation" << endl;

show("message", message_, message_.length());
show("key", key_, message_.length() + 6);
show("pad", pad_, 8);

const uint64_t mac64 = mmh64(message_, key_, pad_);

show("MMH64 MAC", output_octets(mac64), sizeof(mac64));
cout << endl;
#endif // !PACKETCABLE

return 0;
```

}

/*

Here is the VERBOSE output produced by the program if PACKETCABLE is defined:

Example of MMH16 computation

message

4e 6f 77 20 69 73 20 74 68 65 20 74 69 6d 65 2e

key

35 2c cf 84 95 ef d7 df b8 f5 74 05 95 eb 98 d6

pad

ae 07

x 0x4e6f y 0x352c sum 0x104a7614

x 0x7720 y 0xcf84 sum 0xf9bac294

x 0x6973 y 0x95ef sum 0xce0a23f1

x 0x2074 y 0xd7df sum 0xc8f3d4fd

x 0x6865 y 0xb8f5 sum 0xabfb55a6

x 0x2074 y 0x7405 sum 0xbab087ea

x 0x696d y 0x95eb sum 0x8f00bff9

x 0x652e y 0x98d6 sum 0x663aa46d

sum mod F4, truncated to 16 bits: 0x3e33

pad variable: 0xae07

mmh16 value: 0xec3a

MMH16 MAC

ec 3a

Example of MMH32 computation

message

4e 6f 77 20 69 73 20 74 68 65 20 74 69 6d 65 2e

key

35 2c cf 84 95 ef d7 df b8 f5 74 05 95 eb 98 d6

eb 98

pad

bd e1 89 7b

x 0x4e6f y 0x352c sum 0x104a7614

x 0x7720 y 0xcf84 sum 0xf9bac294

x 0x6973 y 0x95ef sum 0xce0a23f1

x 0x2074 y 0xd7df sum 0xc8f3d4fd

x 0x6865 y 0xb8f5 sum 0xabfb55a6

x 0x2074 y 0x7405 sum 0xbab087ea

x 0x696d y 0x95eb sum 0x8f00bff9

x 0x652e y 0x98d6 sum 0x663aa46d

sum mod F4, truncated to 16 bits: 0x3e33

pad variable: 0xbde1

mmh16 value: 0xfc14

x 0x4e6f y 0xcf84 sum 0xf125323c

x 0x7720 y 0x95ef sum 0xbfca091c

x 0x6973 y 0xd7df sum 0xaf427949

x 0x2074 y 0xb8f5 sum 0xa640e84d

x 0x6865 y 0x7405 sum 0xd590b646

x 0x2074 y 0x95eb sum 0xc81e04c2

x 0x696d y 0x98d6 sum 0x9da1dde0

x 0x652e y 0xeb98 sum 0x95912b30

sum mod F4, truncated to 16 bits: 0x959f

pad variable: 0x897b

mmh16 value: 0x1f1a

MMH32 MAC

fc 14 1f 1a

Here is the VERBOSE output produced by the program if PACKETCABLE is not defined:

Example of MMH16 computation

message

```
54 68 65 20 4d 61 67 69 63 20 57 6f 72 64 73 20
61 72 65 20 53 71 75 65 61 6d 69 73 68 20 4f 73
73 69 66 72 61 67 65
```

key

```
00 01 02 03 04 05 06 07 08 09 0a 0b 0c 0d 0e 0f
10 11 12 13 14 15 16 17 18 19 1a 1b 1c 1d 1e 1f
20 21 22 23 24 25 26
```

pad

01 02

```
x 0x5468 y 0x01 sum 0x5468
x 0x6520 y 0x203 sum 0xc3c8
x 0x4d61 y 0x405 sum 0x20caad
x 0x6769 y 0x607 sum 0x472148c
x 0x6320 y 0x809 sum 0x78e90ac
x 0x576f y 0xa0b sum 0xafca871
x 0x7264 y 0xc0d sum 0x105f2785
x 0x7320 y 0xe0f sum 0x16b1a665
x 0x6172 y 0x1011 sum 0x1ccf3ef7
x 0x6520 y 0x1213 sum 0x23f30057
x 0x5371 y 0x1415 sum 0x2a7eac9c
x 0x7565 y 0x1617 sum 0x349fe6af
x 0x616d y 0x1819 sum 0x3dcba254
x 0x6973 y 0x1a1b sum 0x488c6f75
x 0x6820 y 0x1c1d sum 0x53fbbb15
x 0x4f73 y 0x1e1f sum 0x5d54d402
x 0x7369 y 0x2021 sum 0x6bd0d48b
x 0x6672 y 0x2223 sum 0x7979fa21
x 0x6167 y 0x2425 sum 0x873a8a04
x 0x6500 y 0x2627 sum 0x9647ed04
sum mod F4, truncated to 16 bits: 0x56bc
pad variable: 0x102
mmh16 value: 0x57be
```

MMH16 MAC

57 be

Example of MMH32 computation

message

```
54 68 65 20 4d 61 67 69 63 20 57 6f 72 64 73 20
61 72 65 20 53 71 75 65 61 6d 69 73 68 20 4f 73
73 69 66 72 61 67 65
```

key

```
00 01 02 03 04 05 06 07 08 09 0a 0b 0c 0d 0e 0f
10 11 12 13 14 15 16 17 18 19 1a 1b 1c 1d 1e 1f
20 21 22 23 24 25 26 27 28
```

pad

01 02 03 04

```
x 0x5468 y 0x01 sum 0x5468
x 0x6520 y 0x203 sum 0xc3c8
x 0x4d61 y 0x405 sum 0x20caad
x 0x6769 y 0x607 sum 0x472148c
x 0x6320 y 0x809 sum 0x78e90ac
x 0x576f y 0xa0b sum 0xafca871
x 0x7264 y 0xc0d sum 0x105f2785
x 0x7320 y 0xe0f sum 0x16b1a665
x 0x6172 y 0x1011 sum 0x1ccf3ef7
x 0x6520 y 0x1213 sum 0x23f30057
x 0x5371 y 0x1415 sum 0x2a7eac9c
x 0x7565 y 0x1617 sum 0x349fe6af
x 0x616d y 0x1819 sum 0x3dcba254
x 0x6973 y 0x1a1b sum 0x488c6f75
x 0x6820 y 0x1c1d sum 0x53fbbb15
```

```

x 0x4f73 y 0x1e1f sum 0x5d54d402
x 0x7369 y 0x2021 sum 0x6bd0d48b
x 0x6672 y 0x2223 sum 0x7979fa21
x 0x6167 y 0x2425 sum 0x873a8a04
x 0x6500 y 0x2627 sum 0x9647ed04
sum mod F4, truncated to 16 bits: 0x56bc
pad variable: 0x102
mmh16 value: 0x57be
x 0x5468 y 0x203 sum 0xa9cd38
x 0x6520 y 0x405 sum 0x24046d8
x 0x4d61 y 0x607 sum 0x412aa7f
x 0x6769 y 0x809 sum 0x7519530
x 0x6320 y 0xa0b sum 0xb351790
x 0x576f y 0xc0d sum 0xf52bc33
x 0x7264 y 0xe0f sum 0x159ae80f
x 0x7320 y 0x1011 sum 0x1cd48d2f
x 0x6172 y 0x1213 sum 0x23b5cca5
x 0x6520 y 0x1415 sum 0x2ba49845
x 0x5371 y 0x1617 sum 0x32d7cd6c
x 0x7565 y 0x1819 sum 0x3de4bc49
x 0x616d y 0x1a1b sum 0x47d414c8
x 0x6973 y 0x1c1d sum 0x53689acf
x 0x6820 y 0x1e1f sum 0x5fa8f6af
x 0x4f73 y 0x2021 sum 0x69a19482
x 0x7369 y 0x2223 sum 0x79054ddd
x 0x6672 y 0x2425 sum 0x877c2457
x 0x6167 y 0x2627 sum 0x96004508
x 0x6500 y 0x2829 sum 0xa5d87208
sum mod F4, truncated to 16 bits: 0xcc30
pad variable: 0x304
mmh16 value: 0xcf34
MMH32 MAC
57 be cf 34

```

Example of MMH64 computation

```

message
54 68 65 20 4d 61 67 69 63 20 57 6f 72 64 73 20
61 72 65 20 53 71 75 65 61 6d 69 73 68 20 4f 73
73 69 66 72 61 67 65
key
00 01 02 03 04 05 06 07 08 09 0a 0b 0c 0d 0e 0f
10 11 12 13 14 15 16 17 18 19 1a 1b 1c 1d 1e 1f
20 21 22 23 24 25 26 27 28 29 2a 2b 2c
pad
01 02 03 04 05 06 07 08
x 0x5468 y 0x01 sum 0x5468
x 0x6520 y 0x203 sum 0xcbc3c8
x 0x4d61 y 0x405 sum 0x202caad
x 0x6769 y 0x607 sum 0x472148c
x 0x6320 y 0x809 sum 0x78e90ac
x 0x576f y 0xa0b sum 0xafca871
x 0x7264 y 0xc0d sum 0x105f2785
x 0x7320 y 0xe0f sum 0x16b1a665
x 0x6172 y 0x1011 sum 0x1ccf3ef7
x 0x6520 y 0x1213 sum 0x23f30057
x 0x5371 y 0x1415 sum 0x2a7eac9c
x 0x7565 y 0x1617 sum 0x349fe6af
x 0x616d y 0x1819 sum 0x3dcba254
x 0x6973 y 0x1a1b sum 0x488c6f75
x 0x6820 y 0x1c1d sum 0x53fbbb15
x 0x4f73 y 0x1e1f sum 0x5d54d402
x 0x7369 y 0x2021 sum 0x6bd0d48b
x 0x6672 y 0x2223 sum 0x7979fa21

```

```
x 0x6167 y 0x2425 sum 0x873a8a04
x 0x6500 y 0x2627 sum 0x9647ed04
sum mod F4, truncated to 16 bits: 0x56bc
pad variable: 0x102
mmh16 value: 0x57be
x 0x5468 y 0x203 sum 0xa9cd38
x 0x6520 y 0x405 sum 0x24046d8
x 0x4d61 y 0x607 sum 0x412aa7f
x 0x6769 y 0x809 sum 0x7519530
x 0x6320 y 0xa0b sum 0xb351790
x 0x576f y 0xc0d sum 0xf52bc33
x 0x7264 y 0xe0f sum 0x159ae80f
x 0x7320 y 0x1011 sum 0x1cd48d2f
x 0x6172 y 0x1213 sum 0x23b5cca5
x 0x6520 y 0x1415 sum 0x2ba49845
x 0x5371 y 0x1617 sum 0x32d7cd6c
x 0x7565 y 0x1819 sum 0x3de4bc49
x 0x616d y 0x1a1b sum 0x47d414c8
x 0x6973 y 0x1c1d sum 0x53689acf
x 0x6820 y 0x1e1f sum 0x5fa8f6af
x 0x4f73 y 0x2021 sum 0x69a19482
x 0x7369 y 0x2223 sum 0x79054ddd
x 0x6672 y 0x2425 sum 0x877c2457
x 0x6167 y 0x2627 sum 0x96004508
x 0x6500 y 0x2829 sum 0xa5d87208
sum mod F4, truncated to 16 bits: 0xcc30
pad variable: 0x304
mmh16 value: 0xcf34
x 0x5468 y 0x405 sum 0x1534608
x 0x6520 y 0x607 sum 0x3b4c9e8
x 0x4d61 y 0x809 sum 0x6228a51
x 0x6769 y 0xa0b sum 0xa3115d4
x 0x6320 y 0xc0d sum 0xedb9e74
x 0x576f y 0xe0f sum 0x13a8cff5
x 0x7264 y 0x1011 sum 0x1ad6a899
x 0x7320 y 0x1213 sum 0x22f773f9
x 0x6172 y 0x1415 sum 0x2a9c5a53
x 0x6520 y 0x1617 sum 0x33563033
x 0x5371 y 0x1819 sum 0x3b30ee3c
x 0x7565 y 0x1a1b sum 0x472991e3
x 0x616d y 0x1c1d sum 0x51dc873c
x 0x6973 y 0x1e1f sum 0x5e44c629
x 0x6820 y 0x2021 sum 0x6b563249
x 0x4f73 y 0x2223 sum 0x75ee5502
x 0x7369 y 0x2425 sum 0x8639c72f
x 0x6672 y 0x2627 sum 0x957e4e8d
x 0x6167 y 0x2829 sum 0xa4c6000c
x 0x6500 y 0x2a2b sum 0xb568f70c
sum mod F4, truncated to 16 bits: 0x41a3
pad variable: 0x506
mmh16 value: 0x46a9
x 0x5468 y 0x607 sum 0x1fcbcd8
x 0x6520 y 0x809 sum 0x5294cf8
x 0x4d61 y 0xa0b sum 0x8326a23
x 0x6769 y 0xc0d sum 0xd109678
x 0x6320 y 0xe0f sum 0x12822558
x 0x576f y 0x1011 sum 0x17fee3b7
x 0x7264 y 0x1213 sum 0x20126923
x 0x7320 y 0x1415 sum 0x291a5ac3
x 0x6172 y 0x1617 sum 0x3182e801
x 0x6520 y 0x1819 sum 0x3b07c821
x 0x5371 y 0x1a1b sum 0x438a0f0c
x 0x7565 y 0x1c1d sum 0x506e677d
```

```
x 0x616d y 0x1e1f sum 0x5be4f9b0
x 0x6973 y 0x2021 sum 0x6920f183
x 0x6820 y 0x2223 sum 0x77036de3
x 0x4f73 y 0x2425 sum 0x823b1582
x 0x7369 y 0x2627 sum 0x936e4081
x 0x6672 y 0x2829 sum 0xa38078c3
x 0x6167 y 0x2a2b sum 0xb38bbb10
x 0x6500 y 0x2c2d sum 0xc4f97c10
sum mod F4, truncated to 16 bits: 0xb717
pad variable: 0x708
mmh16 value: 0xbelf
MMH64 MAC
57 be cf 34 46 a9 be 1f
*/
```

Appendix III Certification Authority and Provisioning Guidelines (Informative)

III.1 Certificate Format and Extensions

This section describes the certificate format and extensions used by CableLabs certification authorities (CA) and summarizes the fields of [X.509] version 3 certificates. The CableLabs certificate PKI hierarchy is shown in Figure III-1

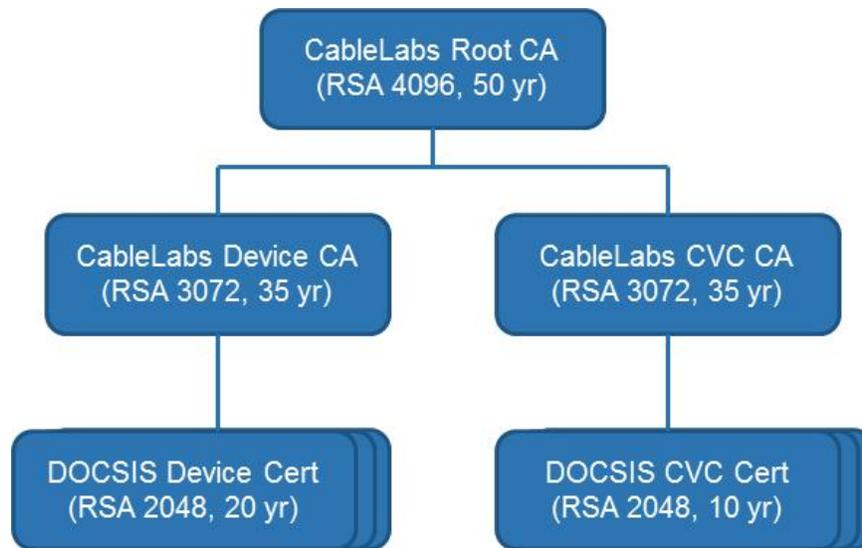

Figure III-1 - Certificate PKI Hierarchy

All certificates and CRLs described in this specification are signed with the RSA signature algorithm, using SHA-256 as the hash function. The RSA signature algorithm is described in PKCS #1 [RSA1]; SHA-256 is described in [FIPS 180-4].

Names in [X.509] are SEQUENCEs of RelativeDistinguishedNames, which are in turn SETs of AttributeTypeAndValue. AttributeTypeAndValue is a SEQUENCE of an AttributeType (an OBJECT IDENTIFIER) and an AttributeValue. The value of the countryName attribute is a 2-character PrintableString, chosen from [ISO 3166]; all other AttributeValues are encoded as either UTF8String or PrintableString character strings. The PrintableString encoding is used if the character string contains only characters from the PrintableString set, specifically:

```

abcdefghijklmnopqrstuvwxyzABCDEFGHIJKLMNOPQRSTUVWXYZ
0123456789
'()+, -./: =? and space.

```

The UTF8String type is used if the character string contains characters not in the PrintableString set.

The DER-encoded tbsCertificate.issuer field of a valid DOCSIS certificate is an exact binary match to the DER-encoded tbsCertificate.subject field of its issuer certificate.

III.2 CableLabs Root CA Certificate

Table III-1 - CableLabs Root CA Certificate

Version		v3		
Serial number		Unique Positive Integer assigned by the CA		
Issuer DN		c=US o=CableLabs ou=Root CA01 cn=CableLabs Root Certification Authority		
Subject DN		c=US o=CableLabs ou=Root CA01 cn=CableLabs Root Certification Authority		
Validity Period		50 yrs		
Public Key Algorithm		Sha256WithRSAEncryption (1 2 840 113549 1 1 11)		
Keysize		4096-bits		
Parameters		NULL		
Standard Extensions	OID	Include	Criticality	Value
keyUsage	{id-ce 15}	X	TRUE	
keyCertSign				Set
cRLSign				Set
basicConstraints	{id-ce 19}	X	TRUE	
cA				Set
subjectKeyIdentifier	{id-ce 14}	X	FALSE	
keyIdentifier				Calculated per Method 1
subjectAltName	{id-ce 17}	O	FALSE	
directoryName				Set by the issuing CA

III.3 CableLabs Device CA Certificate

Table III-2 - CableLabs Device CA Certificate

Version		v3		
Serial number		Unique Positive Integer assigned by the CA		
Issuer DN		c=US o=CableLabs ou=Root CA01 cn=CableLabs Root Certification Authority		
Subject DN		c=US o=CableLabs ou=Device CA01 cn=CableLabs Device Certification Authority		
Validity Period		35 yrs		
Public Key Algorithm		Sha256WithRSAEncryption (1 2 840 113549 1 1 11)		
Keysize		3072-bits		
Parameters		NULL		
Standard Extensions	OID	Include	Criticality	Value
keyUsage	{id-ce 15}	X	TRUE	

Version		v3		
keyCertSign				Set
cRLSign				Set
basicConstraints	{id-ce 19}	X	TRUE	
cA				Set
pathLenConstraint				0
subjectKeyIdentifier	{id-ce 14}	X	FALSE	
keyIdentifier				Calculated per Method 1
authorityKeyIdentifier	{id-ce 35}	X	FALSE	
keyIdentifier				Calculated per Method 1
subjectAltName	{id-ce 17}	O	FALSE	
directoryName				Set by the issuing CA for online CAs

III.4 CM Device Certificate

Table III-3 - CM Device Certificate

Version		v3		
Serial number		Unique Positive Integer assigned by the CA		
Issuer DN		c=US o=CableLabs ou=Device CA01 cn=CableLabs Device Certification Authority		
Subject DN		c=<Country of Manufacturer> o=<Company Name> ou=<Manufacturing Location> cn=<MAC Address>		
Validity Period		20 yrs		
Public Key Algorithm		Sha256WithRSAEncryption (1 2 840 113549 1 1 11)		
Keysize		2048-bits		
Parameters		NULL		
Standard Extensions	OID	Include	Criticality	Value
keyUsage	{id-ce 15}	X	TRUE	
digitalSignature				Set
keyEncipherment				Set
authorityKeyIdentifier	{id-ce 35}	X	FALSE	
keyIdentifier				Calculated per Method 1

Values in angle brackets (<>) indicate that appropriate text as indicated below is present:

- <Country of Manufacturer>: two-letter country code;
- <Company Name>: name that identifies the company;
- <Manufacturing Location>: name that identifies the location of manufacture;
- <MAC Address>: MAC address of the CM.

The MAC address in the CM Certificate will be the same as the MAC address in the BPKM Attributes field.

The MAC Address is expressed as six pairs of hexadecimal digits separated by single colons (:), e.g., 00:60:21:A5:0A:23. Hexadecimal digits greater than 9 are expressed as uppercase letters.

III.5 CableLabs DOCSIS CVC CA Certificate

Table III-4 - CableLabs DOCSIS CVC CA Certificate

Version		v3		
Serial number		Unique Positive Integer assigned by the CA		
Issuer DN		c=US o=CableLabs ou=Root CA01 cn=CableLabs Root Certification Authority		
Subject DN		c=US o=CableLabs ou=CVC CA01 cn=CableLabs CVC Certification Authority		
Validity Period		35 yrs		
Public Key Algorithm		Sha256WithRSAEncryption (1 2 840 113549 1 1 11)		
Keysize		3072-bits		
Parameters		NULL		
Standard Extensions	OID	Include	Criticality	Value
keyUsage	{id-ce 15}	X	TRUE	
keyCertSign				Set
cRLSign				Set
basicConstraints	{id-ce 19}	X	TRUE	
cA				Set
pathLenConstraint				0
subjectKeyIdentifier	{id-ce 14}	X	FALSE	
keyIdentifier				Calculated per Method 1
authorityKeyIdentifier	{id-ce 35}	X	FALSE	
keyIdentifier				Calculated per Method 1
subjectAltName	{id-ce 17}	O	FALSE	
directoryName				Set by the issuing CA for online CAs

III.6 Code Verification Certificate

Table III-5 - Code Verification Certificate

Version		v3		
Serial number		Unique Positive Integer assigned by the CA		
Issuer DN		c=US o=CableLabs ou=CVC CA01 cn=CableLabs CVC Certification Authority		
Subject DN		c=<Country of Manufacturer> o=<Company Name> cn=Code Verification Certificate		
Validity Period		Up to 10 yrs		
Public Key Algorithm		Sha256WithRSAEncryption (1 2 840 113549 1 1 11)		
Keysize		2048-bits		
Parameters		NULL		
Standard Extensions	OID	Include	Criticality	Value

Version		v3		
extKeyUsage	{id-ce 37}	X	TRUE	
codeSigning				Set
authorityKeyIdentifier	{id-ce 35}	X	FALSE	
keyIdentifier				Calculated per Method 1

Values in angle brackets (<>) indicate that appropriate text as indicated below is present:

<Country of Manufacturer>: two-letter country code;

<Company Name>: name that identifies the company

Co-signer CVCs will have a unique numeric value for the <Company Name> which is assigned by CableLabs. The value is a printable string of eight hexadecimal digits. Each hexadecimal digit in the name is chosen from the ranges 0x30 to 0x39 or 0x41 to 0x46. The string 0x3030303030303030 is not assigned.

When a CVC is renewed the orname and validity start time of the old CVC will be used for the new CVC. The validity end time will be extended 10 years.

III.7 Certificate Installation

Cable operators or CMTS vendors install the CableLabs Root CA Certificate in the CMTS as a trust anchor for validating certificates sent by the CM.

The following certificates are installed in the CM during manufacturing:

- CableLabs Root CA Certificate (used for validating code download images)
- CableLabs Device CA Certificate
- CM Device Certificate and its corresponding private key
- Legacy certificates and keys as defined by DOCSIS 3.0

III.8 CM Code File Signing Policy and Format

CM vendors and cable operators can control the Secure Software Download process based on their policies by updating the Manufacturer/Co-Signer CVC or by changing the signingTime in the Manufacturer/Co-Signer CVS (Code Verification Signature). At this time, the DOCSIS 3.0 specifications do not specify the policy related to the CM Code File signing process. However, an example of the policy is specified in this section.

III.8.1 Manufacturer CM Code File Signing Policy

In order to sign code files, the manufacturer obtains a valid CVC from the DOCSIS Root CA.

When signing a code file, a manufacturer may choose not to update the [PKCS#7] signingTime value in the manufacturer signing information. The [PKCS#7] signingTime value should be equal to or greater than the CVC's validity start time. The [PKCS#7] signingTime value is not less than the CVC's validity start time.

The CM vendor and its Manufacturer Code Signing Agent (Mfg CSA), which securely stores the RSA private key corresponding to the RSA public key in the Manufacturer CVC and generates the CVS for the CM Code File, might employ the following policy for the CM Code File signing process.

The Mfg CSA continues to put exactly the same date and time value (T1) in the signingTime field in the Mfg CVS of the CM Code File as long as the vendor does not have any CM Code File to revoke.

Once the vendor realizes there are certain issues in one or more CM Code File(s) and wants to revoke them, the vendor chooses the current date and time value (T2) and starts using T2 as the signingTime value in the Mfg CVS for all the newly created CM Code File from that point. In addition, any CM Code files signed with T1 that are still good are re-signed using T2.

Under this policy, because the multiple CM Code Files make a group of the CM Code Files with the exact same signingTime value in the Msg CVS, the operator can download any CM Code File in the group in any order. That is, among the CM Code Files in the same group, the CM's software can be downgraded if necessary.

III.8.2 Operator CM Code File Signing Policy

Operators should verify that the code image as received from a vendor is exactly as built by the trusted manufacturer.

The operator may choose to co-sign code images destined for use on its network.

All code images downloaded to a CM across the network are signed in accordance with this specification.

III.8.3 CM Code File Format¹³

A single file is used to encapsulate the code for the cable modem.

The code file is a DOCSIS [PKCS#7] signed data message that includes:

- The Manufacturer Code Verification Signature (CVS);
- The Manufacturer Code Verification Certificate (CVC);
- The issuing CVC CA Certificate;
- The code image (compatible with the destination CM) as signed content;
- Optionally, when the MSO co-signs the code file:
 - a) The Co-Signer CVS;
 - b) The Co-signer CVC;
 - c) The issuing CVC CA Certificate; this certificate does not need to be separately added when it is identical to the issuing CVC CA certificate of the Manufacturer CVC.
- Optional Device CA Certificate
- Optional Root CA Certificate

For upgrades using a legacy code file, the code file is a DOCSIS [PKCS#7] signed data message that includes:

- The Manufacturer Code Verification Signature (CVS);
- The Manufacturer Code Verification Certificate (CVC), signed by the DOCSIS Root CA;
- The code image (compatible with the destination CM) as signed content;
- Optionally, when the MSO co-signs the code file:
 - a) The Co-signer CVS;
 - b) The Co-signer CVC signed by the DOCSIS Root CA.
- Optional Root CA Public Key for the CVC verification;
- Optional Manufacturer Certificate(s).

¹³ Updated per SEC3.1-N-15.1297-1 on 5/29/15 by PO.

The code file complies with [PKCS#7] and is DER encoded. The code file matches the structure shown below. A code file example is shown in Annex D.

Table III-6 – CM Code File

Code File Structure	Description
[PKCS#7] Digital Signature{	
ContentInfo	
contentType	SignedData
signedData()	EXPLICIT signed-data content value; includes CVS and [X.509] CVC
}	
SignedContent{	
DownloadParameters {	Mandatory TLV format (Type 28) defined in the Section 7.2.2.28. (Length is zero if there are no sub-TLVs.)
RootCAPublicKey()	Optional TLV for the legacy PKI Root CA Public Key for CVC Verification, formatted according to the RSA-Public-Key TLV format (Type 4) defined in the Section 7.2.2.4.
MfgCert()	Optional TLV for one DER-encoded legacy PKI Manufacturer CA Certificate formatted according to the CA-Certificate TLV format (Type 17) defined in the Section 7.2.2.17.
DeviceCACert()	Optional TLV for one DER-encoded new PKI certificate formatted according to the Device-CA-Certificate TLV format (Type 53) defined in the Section 7.2.2.31.
RootCACert()	Optional TLV for one DER-encoded new PKI certificate formatted according to the Root-CA-Certificate TLV format (Type 54) defined in the Section 7.2.2.32.
}	
CodeImage()	Upgrade code image
}	

III.8.3.1 DOCSIS PKCS#7 Signed Data

The signedData field of the DOCSIS [PKCS#7] Digital Signature matches the DER encoded structure defined in Appendix III.

III.8.3.1.1 Code Signing Keys

The digital signature uses the RSA Encryption Algorithm [RSA3] with SHA-256 [FIPS 180-4]. The RSA key modulus is at least 2048 bits in length.

Table III-7 - DOCSIS PKCS#7 Signed Data¹⁴

PKCS#7 Field	Description
signedData {	
Version	version = 1
digestAlgorithmIdentifiers	SHA-256
contentInfo	
contentType	data (SignedContent is concatenated at the end of the [PKCS#7] structure)
certificates {	DOCSIS Code Verification Certification (CVC)
mfgCVC()	Required for all code files
mfgCVCCA()	Required for all code files using the new PKI
cosignerCVC()	Optional; required for cable operator co-signatures
cosignerCVCCA()	Optional; required for cable operator co-signatures using the new PKI when cosignerCVCCA certificate is not identical to the mfgCVCCA certificate.

¹⁴ Table updated per SEC3.1-N-15.1297-1 on 7/29/15 by PO.

PKCS#7 Field	Description
} end certificates	
SignerInfo{	
MfgSignerInfo {	Required for all code files
Version	version = 1
issuerAndSerialNumber	from the signer's certificate
issuerName	distinguished name of the certificate issuer
certificateSerialNumber	from CVC; Integer, size (1..20) octets
digestAlgorithm	SHA-256
authenticatedAttributes	
contentType	data; contentType of signedContent
signingTime	UTCTime (GMT), YYMMDDhhmmssZ
messageDigest	digest of the content as defined in [PKCS#7]
digestEncryptionAlgorithm	rsaEncryption
encryptedDigest	
} end mfg signer info	
MsoSignerInfo {	OPTIONAL; required for cable operator co-signatures
Version	version =1
issuerAndSerialNumber	from the signer's certificate
issuerName	distinguished name of the certificate issuer
certificateSerialNumber	from CVC; Integer, size (1..20) octets
digestAlgorithm	SHA-256
authenticatedAttributes	
contentType	data; contentType of signedContent
signingTime	UTCTime (GMT), YYMMDDhhmmssZ
messageDigest	digest of the content as defined in [PKCS#7]
digestEncryptionAlgorithm	rsaEncryption
encryptedDigest	
} end mso signer info	
} end signer info	
} end signed data	

III.8.3.1.2 Code Verification Certificate Format

The format used for the CVC is defined in Appendix III.6.

III.8.3.1.3 Code Verification Certificate Revocation

The CM is not required to support CVC revocation.

However, there is a method for revoking CVCs based on the validity start date of the certificate. This method requires that an updated CVC be delivered to the cable modem with an updated validity start time. Once the CVC is successfully validated, the validity start time will update the CM's current value of cvcAccessStart (see Section 14.3.2.2).

To expedite the delivery of an updated CVC without requiring the cable modem to process a code upgrade, the CVC may be delivered in either the CM's configuration file or an SNMP MIB. The format of a DOCSIS CVC is the same whether it is in a code file, configuration file, or SNMP MIB.

III.8.3.2 Signed Content

The SignedContent field of the code file contains the CodeImage and the DownloadParameters fields, which may contain up to three items: a Root CA Certificate, a legacy Manufacturer CA certificate, and a Device CA Certificate.

The final code image is in a binary format compatible with the destination CM. In support of the [PKCS#7] signature requirements, the code content is encoded as an OCTET STRING.

Each manufacturer should build their code with additional mechanisms to verify that an upgrade code image is compatible with the destination CM.

Appendix IV Acknowledgements (Informative)

On behalf of the cable industry and our member companies, CableLabs would like to thank the following individuals for their contributions to the development of this specification.

Contributor	Company Affiliation
Sasha Medvinsky	Arris
Doug Nguyen, Margo Dolas, Guy Smith	Broadcom
Brionna Lopez, Stuart Hoggan	CableLabs
Nancy Davoust	Comcast

Since this specification is based on the [DOCSIS BPI+] specification the following individuals and organizations who participated in its development are also acknowledged.

Contributor	Company Affiliation
Mike St. Johns	@Home Corporation
Burcak Beser	3com
Kirk Erichsen	Adelphia
Doc Evans	ARRIS Interactive
Bill Aiello	AT&T
Mohan Gundu	BigBand Networks
Doug Nguyen, Jeff Carr, Lisa Denney, Niki Pantelias	Broadcom Corporation
Matt Schmitt, Oscar Marcia, Stuart Hoggan	CableLabs
Man Wong, Shengyou Zeng	Cisco Systems
James Yee, John Pickens, Mike Sabin	Com21
Brian Epstein, Rick Mayberry	Comcast
Rusty Cashman	Correlant Communications
Ben Bekele	Cox Cable
Han-Seung Koo	ETRI
Jonathan Fellows, Sasha Medvinsky	General Instrument Corporation
Lior Storfer	Libit Signal Processing Ltd.
Katherine Unge, Mark Sumner, Mike Patrick, Nathan Vanderschaaf	Motorola Corporation
Stuart Green, Wilson Sawyer	Nortel Networks
George Hart	Rogers Cable TV Ltd.
Lucy Pollak	Texas Instruments
Kazuyoshi Ozawa	Toshiba

Appendix V Revision History (Informative)

V.1 Engineering Change for CM-SP-SECv3.1-I02-150326

The following Engineering Change was incorporated into CM-SP-SECv3.1-I02-150326.

ECN Identifier	Accepted Date	Title of EC	Author
SECv3.1-15.1251-2	2/25/2015	Security 3.1 Editorial Omnibus	Lopez

V.2 Engineering Change for CM-SP-SECv3.1-I03-150611

The following Engineering Change was incorporated into CM-SP-SECv3.1-I03-150611.

ECN Identifier	Accepted Date	Title of EC	Author
SECv3.1-N-15.1297-1	5/6/2015	SignedData Clarification for Identical mfgCVCCA() and cosignerCVCCA()	Medvinsky

V.3 Engineering Change for CM-SP-SECv3.1-I04-150910

The following Engineering Change was incorporated into CM-SP-SECv3.1-I04-150910.

ECN Identifier	Accepted Date	Title of EC	Author
SECv3.1-N-15.1342-1	8/12/2015	Security 3.1 Omnibus	Lopez

